

# bit Ten

Signal Interface Processor



ideato,  
progettato,  
costruito  
in Italia



# ADVANCED MANUAL

Rev. 1.1c

# Index





<b>1. PRODUCT DESCRIPTION - PRECAUTIONARY NOTES</b>	03
<b>2. PACKAGING CONTENTS</b>	03
<b>3. bit Ten AND DRC INSTALLATION</b>	04
<b>4. CONNECTION PANELS - DESCRIPTION</b>	05
4.1 Multipolar connector	05
4.2 Input signals	06
4.3 Output signals	07
4.4 Inputs - remote control outputs and power supply	07
4.5 Controls and settings	08
<b>5. CONNECTIONS</b>	09
5.1 Power supply and remote turn on	09
5.2 How to turn the bit Ten on / off	09
5.3 Personal computer and Digital Remote Control (DRC)	10
5.4 High-Level input signals	10
5.5 Low-Level input signals	11
5.6 Connection with hands-free phone kit	11
5.7 Output signals	12
<b>6. HOW TO SETUP THE bit Ten WITHOUT A PC</b>	13
6.1 How to calibrate the MASTER Front-Rear input sensitivity	13
6.2 Source de-equalization	14
6.3 Amplifiers sensitivity calibration	16
6.4 How to calibrate the PHONE and AUX IN INPUT sensitivities	16
<b>7. bit Ten SOFTWARE AND DRIVERS INSTALLATION / UNINSTALLATION GUIDE</b>	17
7.1 PC Software installation guide	17
7.2 Drivers installation guide	19
7.3 bit Ten software uninstall	20
<b>8. bit Ten INSTALLATION GUIDE USING A PC</b>	21
8.1 Selecting the MASTER (Front / Rear) inputs and outputs - TARGET Mode	21
8.2 OFFLINE mode	28
8.3 Adjusting acoustic reproduction	29
8.4 Device info	29
8.5 FILE main menu	30
8.6 CONFIG main menu	31
8.7 SELECTED INPUT	32
8.8 CHANNEL MAP	32
8.9 SELECT CHANNEL	32
8.10 FILTER SETTINGS	33
8.11 Set Distance and Delay	35
8.12 Graphic equalizer	37
8.13 Output level	38
8.14 Memory	39
<b>9. TROUBLESHOOTING</b>	40
9.1 Synchronization with a PC	40
9.2 Background noise	40
9.3 Firmware upgrade	40
9.4 RESCUE MODE	43
<b>10. DRC - DIGITAL REMOTE CONTROL</b>	44
10.1 Phone call	45
10.2 SEL button - functions	45
10.3 Bypassing the DRC	45
10.4 DRC firmware upgrade	46
<b>11. bit Ten ACCESSORIES</b>	47
11.1 DRC cable extension kit	47
<b>12. TECHNICAL SPECIFICATIONS</b>	48

## 1. PRODUCT DESCRIPTION / PRECAUTIONARY NOTES

The **bit Ten** is a digital signal processor essential to maximize the acoustic performance of your car audio system. It consists of a 32-bit DSP processor and 24-bit AD and DA converters. It can connect to any factory system, even in vehicles featuring an integrated audio processor, since, thanks to the de-equalization function, the **bit Ten** will send back a linear signal. It features 7 signal inputs: 4 Hi-Level, 1 Aux Stereo, 1 Phone and provides 5 PRE OUT analog outputs. Each output channel has a 31-band equalizer available. It also features a 66-frequency electronic crossover as well as BUTTERWORTH or LINKWITZ filters with 6-24 dB slopes and a digital time delay line. The user can select adjustments that allow him or her to interact with the bit Ten through a remote control device called DRC.

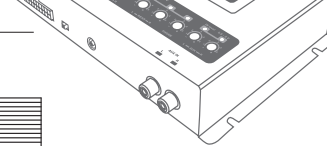
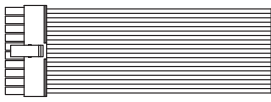
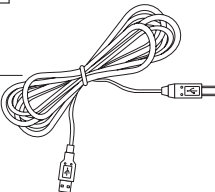
- WARNING:** 1- a PC provided with Windows XP, Windows Vista, Windows 7 or Windows 8 operating system, 1.5 GHz minimum processor speed, 1 GB RAM minimum memory and a graphics card with a minimum resolution of 1024 x 600 pixels are required to install the software and setup the .
- 2- Before connecting your bit Ten, carefully read this manual. Improper connections may cause damage to the bit Ten or to the speakers in the car audio system.

## 2. PACKAGING CONTENTS

- **bit Ten** - Signal Interface Processor 
- Power supply cable / Remote / Inputs 
- 3.0 m / 118.11" USB cable 
- 4 of 4.2 x 20 mm self-tapping, cross-head fixing screws 
- CD ROM with:
  - bit Ten 1.0** software
  - This advanced manual (.pdf format)
  - Test tracks
- Quick start guide 
- Warranty 

### OPTIONAL:

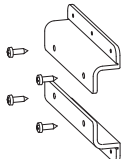
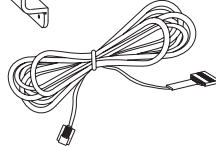
- DRC (Digital Remote Control) control panel 
- 2 fixing brackets with 2.9 x 6.5 mm self-tapping, cross-head screws 
- 4.5 m / 177.16" DRC - AC Link cable 

### 3. bit Ten D and DRC INSTALLATION

#### External dimensions

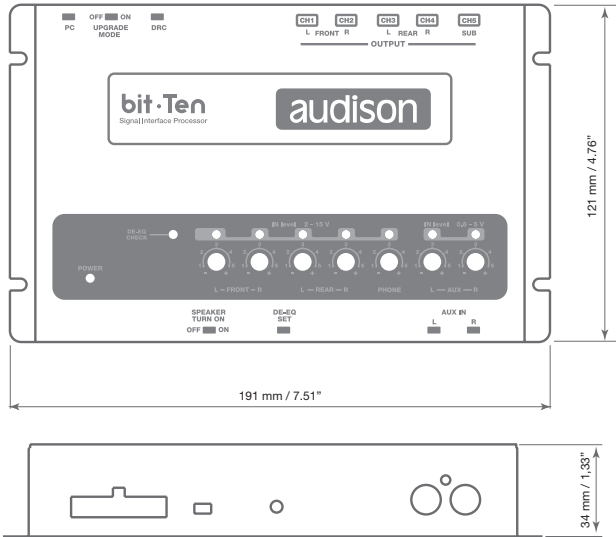

#### Mounting dimensions

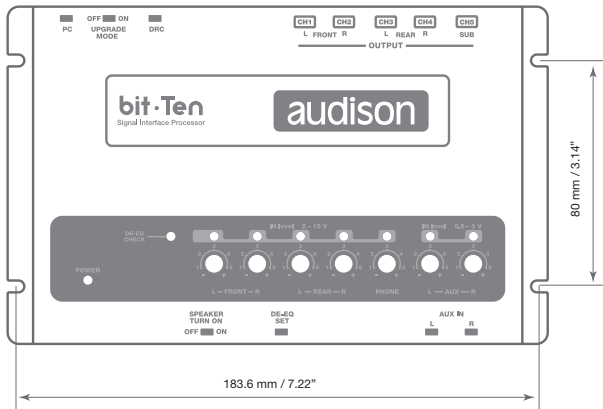

#### How to install

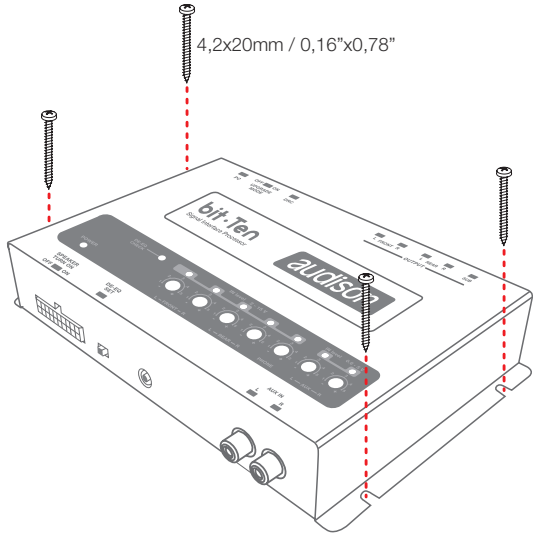

#### DRC (optional)

#### How to install the DRC

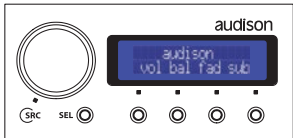
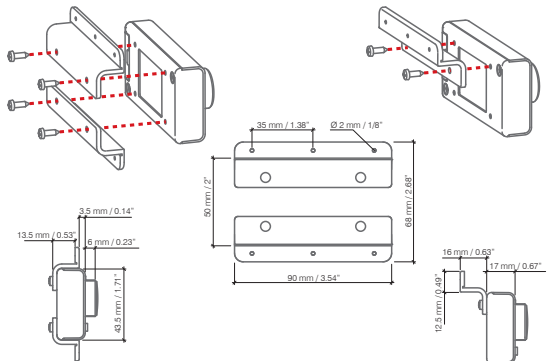

**Warning:** do not use aggressive cleaning agents or abrasive cloth to clean the display. Simply use a soft cotton cloth lightly damped with water.

## 4. CONNECTION PANELS – DESCRIPTION

### 4.1 MULTIPOLAR CONNECTOR

The bit Ten comes with a 20 multipolar interface for input signals, power supply and various control connections.

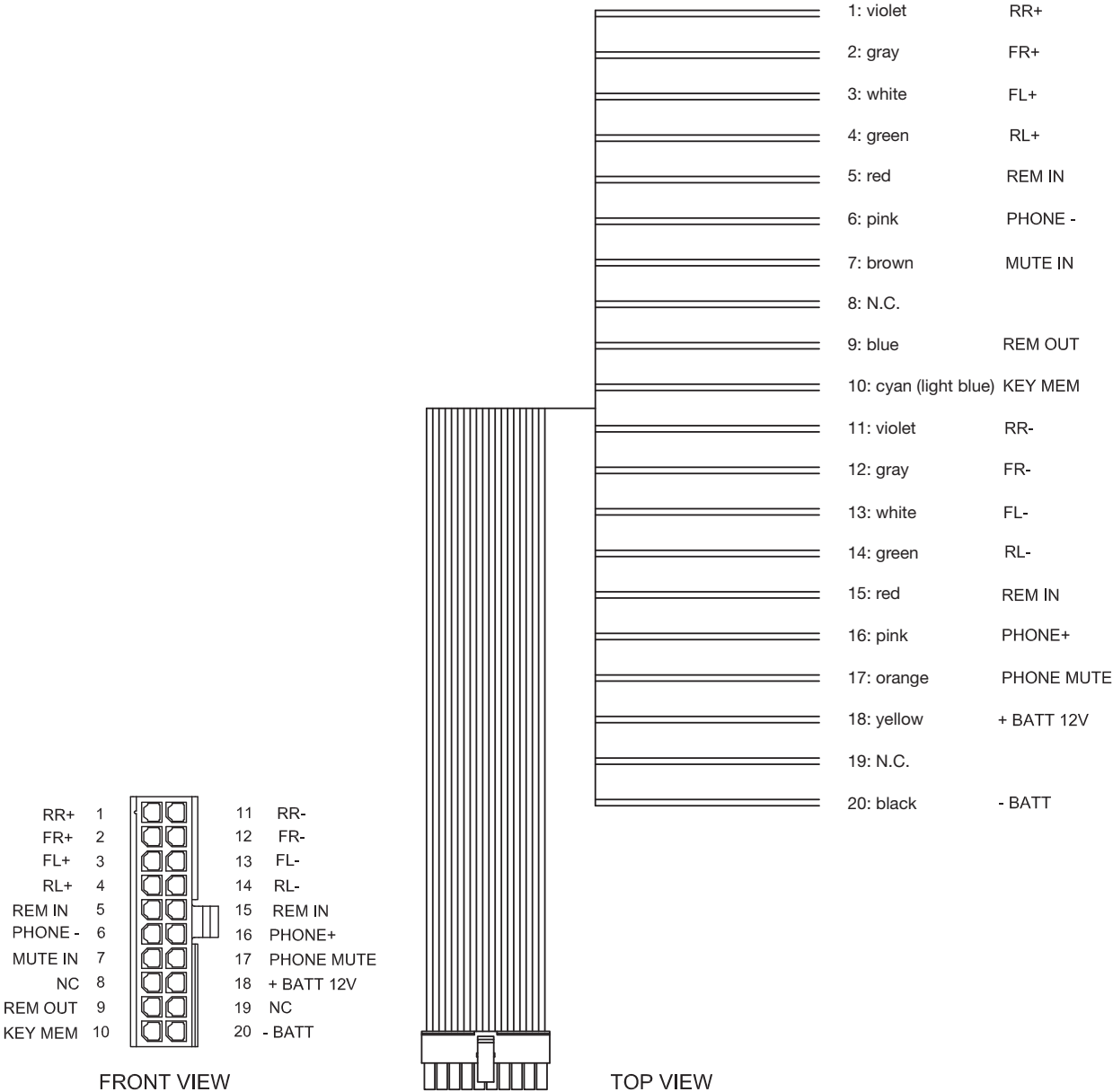

**4.2 INPUT SIGNALS**

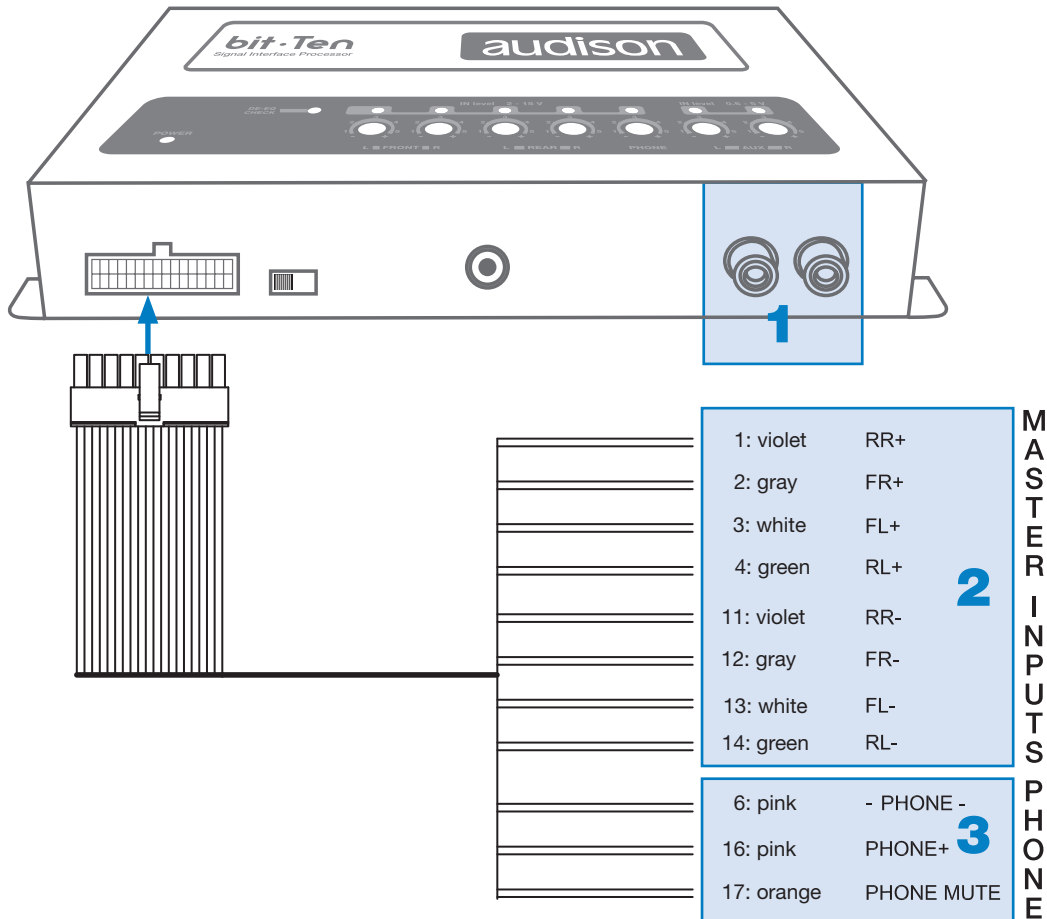

**1. AUX IN L - R;** auxiliary low-level stereo input.  
 The bit Ten comes with an auxiliary stereo signal input to connect an external source, mp3 player, audio sources. Input sensitivity is adjustable from 0.6 to 5 V RMS.

**2. INPUTS; RL - FL - FR - RR. Hi-level MASTER inputs (SPEAKERS).**  
 The bit Ten comes with 4 HI-LEVEL signal inputs to connect amplified signal cables coming from the main analog source. Input sensitivity is adjustable from 2 to 15 V RMS.

**Remark:** If a low-level output source (PRE OUT) with output signal equal or greater than 2 V RMS is available, you can connect it to the high-level MASTER inputs (SPEAKERS). Sensitivity is increased by adjusting the IN LEVEL controls (see 8.1.2 - 8.1.9).

**3. PHONE; input for phone hands-free kits.**  
**IN + - :** Connect the audio output cables coming from the hands-free kit system in use. Input sensitivity is adjustable from 2 to 15 V RMS.  
**MUTE:** Connect the hands-free kit remote mute control (MUTE / PHONE MUTE). This control works by earthing the terminal.

**Remark:** The PHONE MUTE terminal can be used also to enable the AUX input (see 8.6.5).  
 In this case the PHONE input won't be active.



### 4.3 OUTPUT SIGNALS

#### 1. FRONT L-R, REAR L-R, SUB OUTPUTS;

Low-level analog signal.  
 Connection for RCA cables going to the system amplifiers. SUB output is provided with CONSTANT BASS (when varying the fader, the SUB volume does not change). [\(see 5.7\)](#).

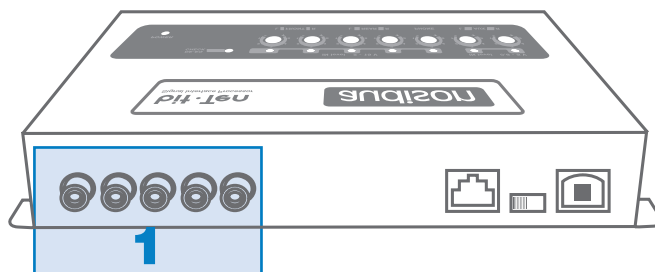

### 4.4 INPUTS – REMOTE CONTROL OUTPUTS AND POWER SUPPLY

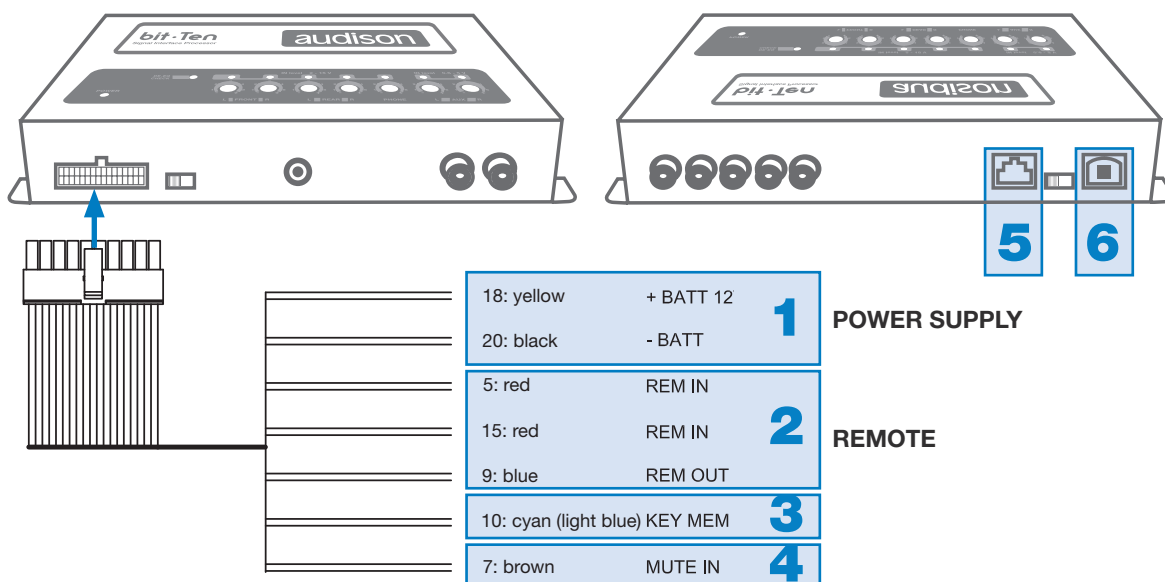

#### 1. POWER SUPPLY.

**+BATT 12V:** Positive connection terminal for car 12V power supply.  
**-BATT:** Power supply negative connection terminal (GND).

**WARNING:** make sure the connection polarity is as indicated on the terminals. A misconnection may result in damage to the **bit Ten**. After applying power, wait at least 10 seconds before turning the **bit Ten** on.

#### 2. REMOTE IN-OUT.

**REM IN:** input to turn on the processor remotely along with the audio signal Remote Out.

**REM OUT:** output to turn on other devices / amplifiers connected after the processor.

From the REMOTE-IN signal, the processor only takes 1 second to supply the signal to the **REM OUT** output. The 130-mA output current capability can also drive an automotive relay (making sure it doesn't exceed 130 mA).

**WARNING:** the **bit Ten** must be switched on before any amplifiers are turned on. The system sources Remote Out must be connected to the product **REM IN**, and the product **REM OUT** is then to be connected to the Remote In of other devices / amplifiers.

**3. KEY MEM**

To turn the processor on and off when the vehicle ignition is turned on / off.

**Remark:** This signal is memory-dependent: if the processor was turned off by a car sub-key connected to the KEY MEM, it will turn on again by turning the ignition key. If the processor was turned off by a different method (e.g. DRC) while the KEY MEM was still active, it will not turn on again through the KEY MEM and you will have to turn it on through either the DRC or REM IN.

**4. MUTE IN:** To mute the bit Ten outputs when starting the engine by connecting the terminal to the starter turn-on input or other devices. This control works by jumping the terminal to 12V.

**Remark:** The MUTE IN terminal can be used to enable the AUX IN input [\(see 8.6.5\)](#). In this case the output mute function,  set by default, will be disabled.

**5. DRC**

DRC (Digital Remote Control) connection to configure the processor.

**6. USB**

USB (type B) connection plug, to connect the processor to a PC and manage its functions through the **bit Ten** software. The connection standard is USB 1.1 / 2.0 compatible.

**4.5 CONTROLS AND SETTINGS**

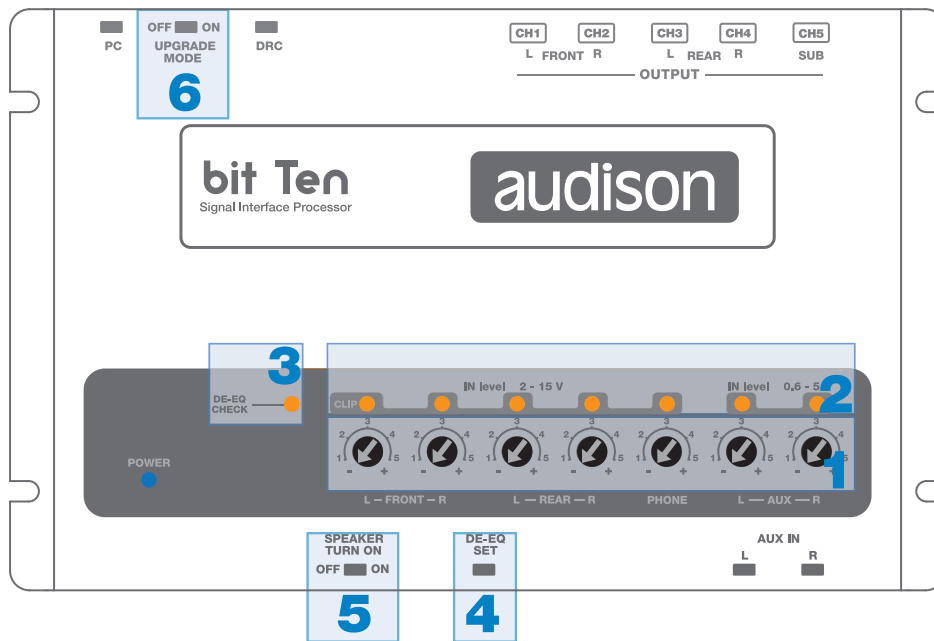

- 1. IN level:** Input signals adjustments.  
By turning the dials counter-clockwise, sensitivity decreases; by turning them clockwise, it increases. This setting is important for an optimal signal / noise ratio [\(see 8.1 - 8.2\)](#).
- 2. CLIP:** Input clipping detector [\(see 8.1 - 8.2\)](#).  
If the LED lights up, it indicates clipping on the selected input.
- 3. DE-EQ CHECK:** When lit, meaning comes from its state [\(see 8.1\)](#).
  - **LED ON:** A de-equalization curve has been recorded.
  - **LED Flashing:** You are performing a de-equalization analysis of the MASTER main input signal [\(see 8.1 - 8.2\)](#).
- 4. DE-EQ SET:** Button to begin analysis or de-equalization functions during system calibration without using a PC [\(see 8.1\)](#).
- 5. SPEAKER TURN ON:**  
Switch OFF does not allow turning the device on from the **MASTER** high-level main input [\(see 4.2.2 - 5.4\)](#).  
Switch ON allows turning the device on from the **MASTER** high-level main input [\(see 5.4\)](#).
- 6. UPGRADE MODE:** Switch ON allows updating in **RESCUE MODE** [\(see 9.4\)](#), and the POWER LED will start flashing.



## 5 CONNECTIONS

### 5.1 POWER SUPPLY AND REMOTE TURN ON

**WARNING:** to power the device, use 1 mm<sup>2</sup> (16 AWG) cables.

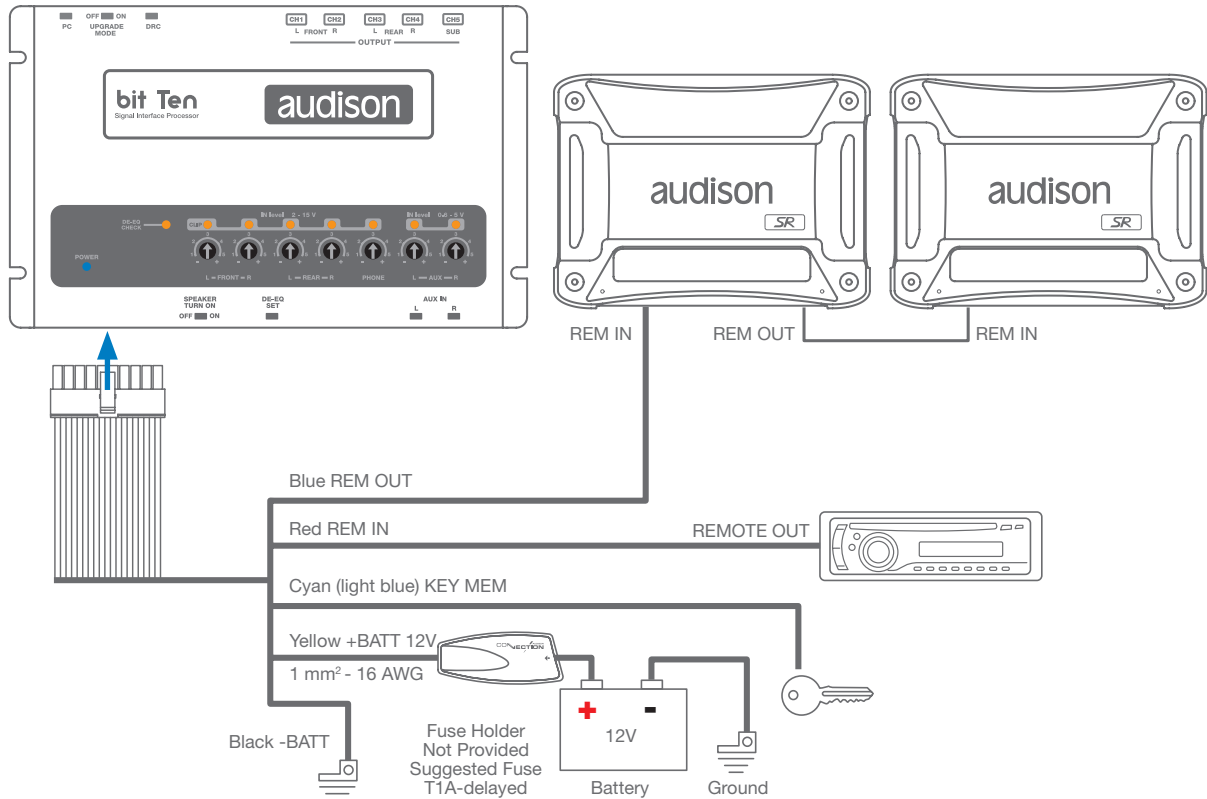

**Remark:** the **bit Ten** is internally protected by a fuse-resistor soldered on its printed circuit board. To replace it contact a service centre. Using an external fuse is recommended, though it is not required.

### 5.2 HOW TO TURN THE bit Ten ON / OFF

The **bit Ten** is on when the **POWER ON LED** lights up in blue. It can be turned on / off in the following ways:

1. Push the **DRC** main control switch (to turn on). Keep the DRC main control knob pressed (to shut down). In this case, no other connections **Remote In / KEY MEM** are required, but they can coexist (see 1.1).
2. Connecting one of the Remote In plugs using a signal coming from one source. The **KEY MEM** connection is not required, but it can coexist.
3. Through the **KEY MEM**. This method is memory-dependent (see 4.4.3).
4. Through the **MASTER (INPUT FL)** input. The **AUTO TURN ON (ART)** function is enabled by connecting an amplified head unit output to the **INPUT FL** input channel. This function can be disabled by moving the **SPEAKER TURN ON** switch to **OFF** (see 4 - 4.5).
5. Automatically through the hands-free phone kit (see 5.6) during its use.
6. Connecting either of the two **MUTE IN / PHONE MUTE** terminals, properly set to automatically enable the **AUX IN** input (see 8.6.5).

**5.3 PERSONAL COMPUTER AND DIGITAL REMOTE CONTROL (DRC)**

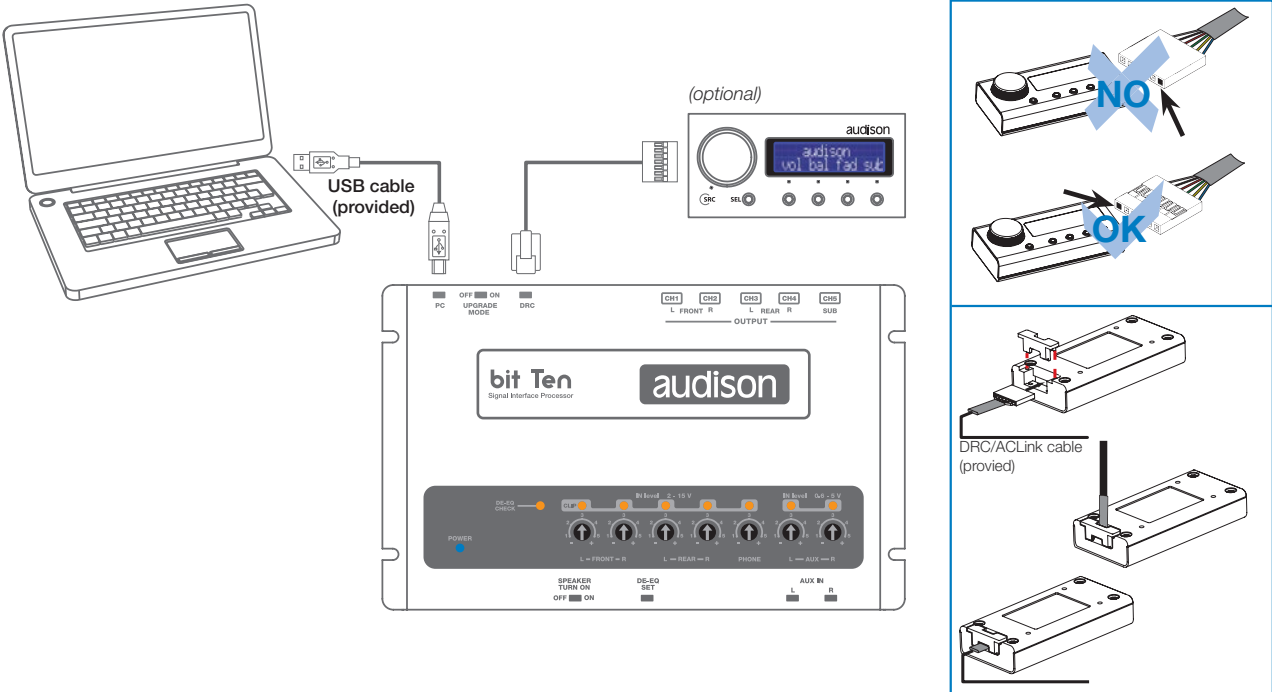

**5.4 HIGH-LEVEL INPUT SIGNALS**

**1. SPEAKERS IN HI-LEVEL STEREO FRONT+REAR**

(see 8.1)

**2. SPEAKERS IN HI-LEVEL MULTICHANNEL**

(see 8.2)

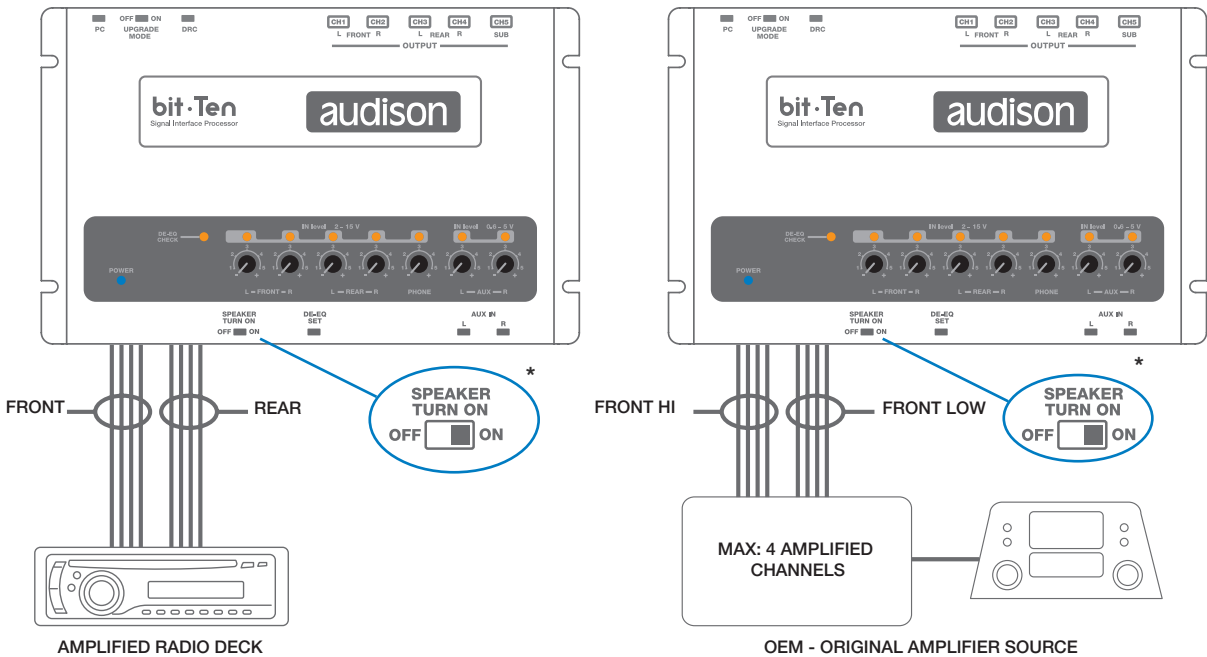

\* To disable the Speaker Turn on function on the Front Left channel, move the indicated switch to the left to "OFF" position.

**5.5 LOW-LEVEL INPUT SIGNALS**

**AUX IN L/R:** Auxiliary analog stereo signal.  
Sensitivity is adjustable from 0.6 to 5 V RMS.

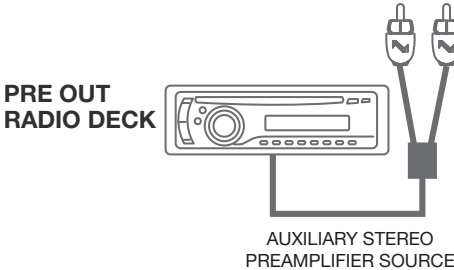
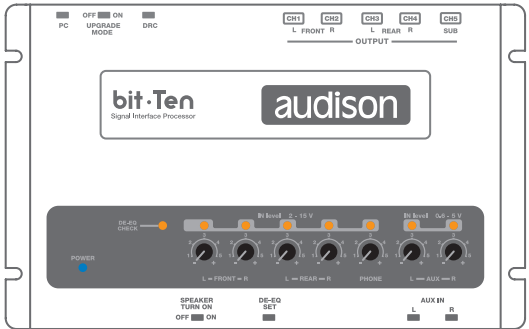
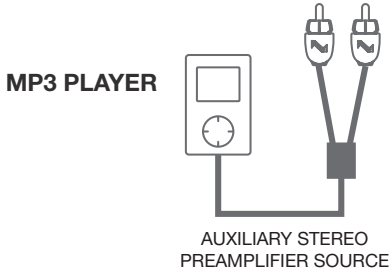
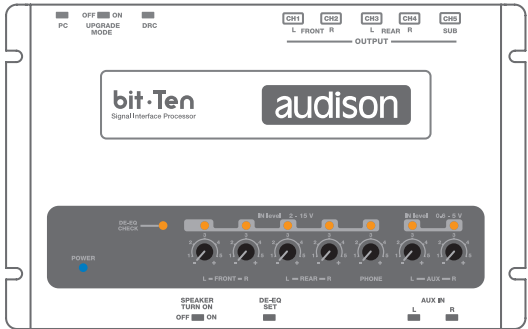

**5.6 CONNECTION WITH HANDS-FREE PHONE KIT**

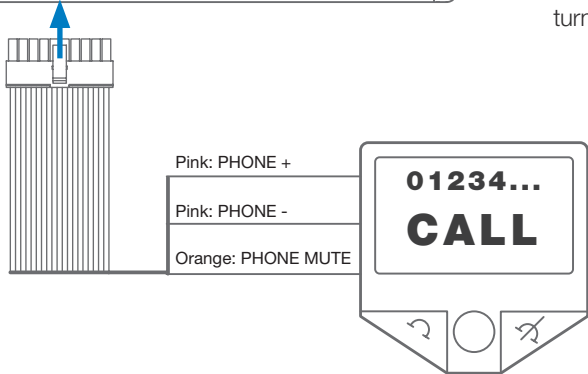
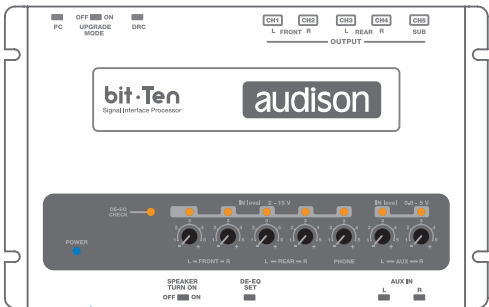

**PHONE +/-** Input compatible with the hands-free kit speaker output (see 4.2.3). Sensitivity adjustable from 2 to 15 V RMS.

**PHONE MUTE: bit Ten ON.** This gives priority to the phone conversation, allowing you to resume audio reproduction when the phone call is finished.

**PHONE MUTE: bit Ten OFF.** This turns the bit Ten on. When a phone call is received, the ring tone is audible after around 5 seconds. Once the phone call is finished, the bit Ten turns off.

**Nota:** The **PHONE MUTE** terminal can be used to enable the **AUX IN** input (see 8.6.5). In this case the user won't be able to interface with the hands-free kit through the **bit Ten**.

### 5.7 OUTPUT SIGNALS

#### OUTPUT TO AN AMPLIFIER'S SYSTEM

Example of a Front Rear + Sub amplifier's system, connected with the default settings (see 8.1).

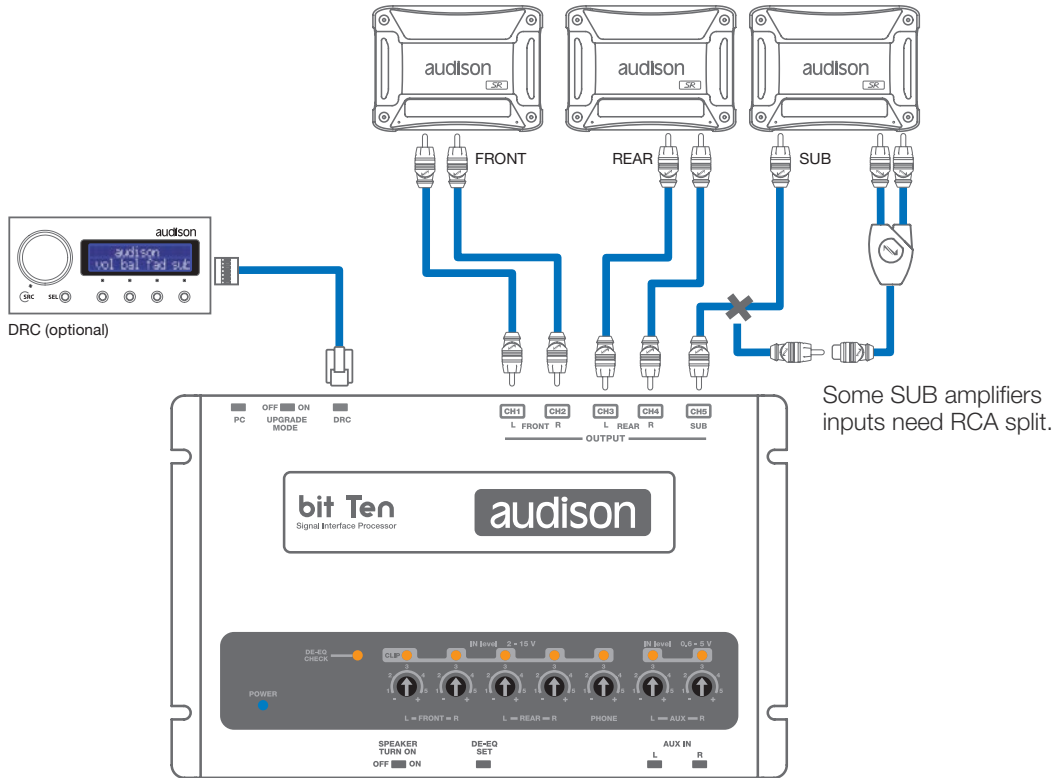

Example of a 2-way active Front + Sub amplifier's system (see 8.2).

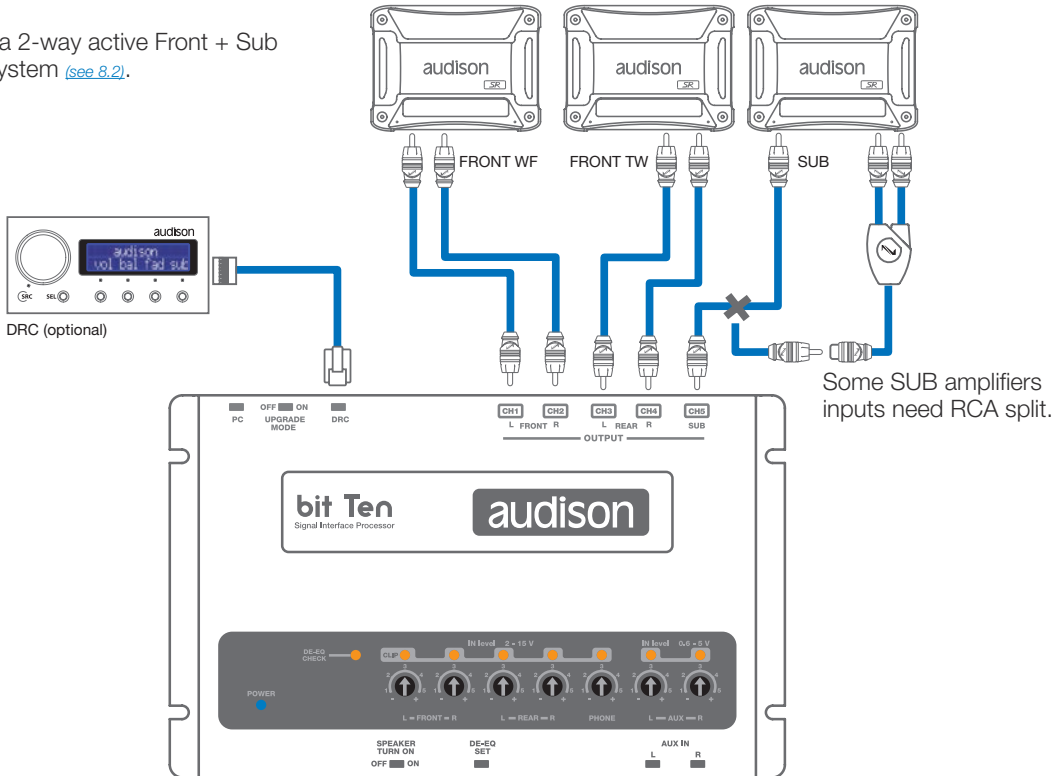

## 6. HOW TO SETUP THE bit Ten WITHOUT A PC

The **bit Ten** can be used without a PC.

In this case, you can mainly use only the DE-EQ (de-equalization) function to eliminate any pre-existing equalization in the audio system, usually installed as standard by the car manufacturer.

The device will store the following default settings:

1. Front and Rear stereo broadband inputs;
2. Phone input with automatic switching when a call is received;
3. AUX input that can be selected if the DRC is available;
4. Front and Rear stereo broadband outputs;
5. Mono Lo-pass filtered SUB output at 150Hz / 12dB Oct.

**WARNING:** All outputs have no equalization or time delays. If you wish to use the Rear output, you will have to connect the head unit Rear outputs to the bit Ten input.



### 6.1 HOW TO CALIBRATE THE MASTER FRONT-REAR INPUT SENSITIVITY

1. **Connect the head unit speaker outputs to the bit Ten high-level input** (see 4.2).  
**Before turning on the system, make sure the amplifiers RCA plugs are disconnected from the bit Ten to avoid speaker damage during the calibration procedure.**

*The input calibration procedure must be performed with the ignition turned on. In this case, the car voltage is about 14.0 Volts. The head unit will provide an undistorted output signal at higher volume.*

2. Make sure that the IN Level knobs for the inputs used (L / R Front, L / R Rear, Phone, Aux IN L-R) are set to minimum sensitivity as in the figure (position -).

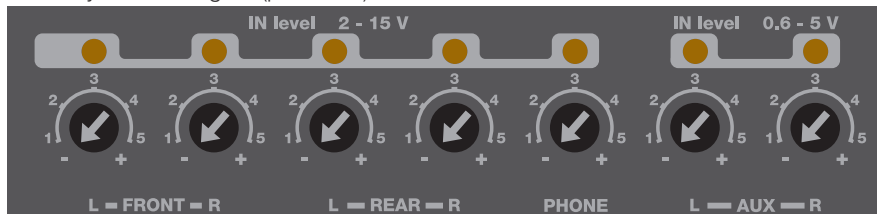

3. Turn on the device and play track 1 of the CD supplied with the **bit Ten**.

- Set all tone controls to zero (flat).
- Set balance and fader to center.
- Adjust the head unit volume to the maximum undistorted output level.
- If the head unit provides an adjustable equalizer, make sure that the controls are set to zero (flat).

**WARNING:** the head unit level must be elevated to the **maximum undistorted** level. If the head unit distortion level can not be tested in advance, bring the volume to approximately 80% of its maximum. If the head unit output level is set **too low**, the device will produce **ground noise** (hissing sound) when playing music tracks. This is due to the low signal / noise ratio provided by the bit Ten input head unit. If you have this problem after you **calibrated the amplifiers sensitivity** (see 7.3), increase the head unit volume and **repeat the bit Ten calibration procedure** as detailed in the following chapter 6.4.

#### Head unit input-level instrument check.

You will need an oscilloscope for this instrument check.

- Connect the head unit output to the oscilloscope.
- Play track 1 of the **bit Ten** CD.
- Set tone, fader and balance controls and the equalizer (if any) to zero (flat).
- Turn on the car.
- Adjust the volume control so that the oscilloscope shows a sine wave with slightly cut peaks, as shown in the figure.
- Note the volume used by the head unit. It must be left in this position for the following operations.

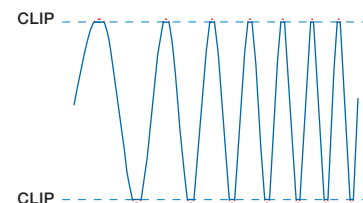

**4. How to IN LEVEL calibrate the MASTER inputs.**

This procedure is delicate and requires particular attention. Improper execution can invalidate the final acoustic results. **The bit Ten outputs must be disconnected from the amplifiers.**

- While playing track 1 of the CD, turn the first knob towards the highest sensitivity (position +).
- When the orange LED lights up or flashes, stop turning and go back slightly until the LED turns off.

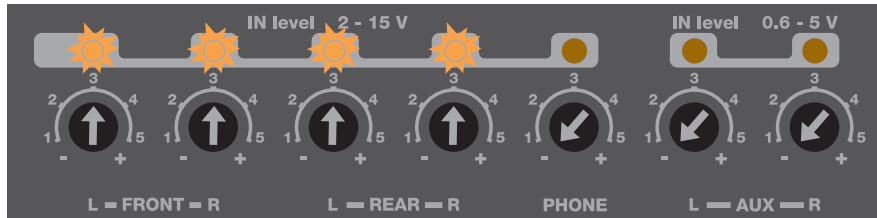

- It is normal for the LED to flash briefly; this indicates correct sensitivity calibration.
- Repeat the procedure for the other 3 Front / Rear knobs.
- Note the calibration level used by the head unit volume control.

**WARNING:** Some factory head units require a low load impedance to enable the outputs (usually the Rear section).



If during the calibration process the input signal level can't be adjusted, it may be necessary to connect in parallel a 47Ω - 3W resistor to the input cables of the channels showing the issue.

*Audio systems installed as standard by car manufacturers often come with equalized outputs.*

*This means that the response curve is not flat and the difference between the highest and the lowest level can reach 6 dB. By calibrating the device so that the LED never lights up, the bit Ten sensitivity may be suboptimal (low) and you may experience noise (whistle) on the speakers. A few quick LED flashes indicate only a small distortion when handling maximum peaks (very occasional) of music tracks.*

*If the source is not equalized, response is flat and the LEDs will always be on or always off. In this case, calibrating is easy because you will simply need to adjust the knobs so that the LEDs turn off just below the point they turn on.*

**6.2 SOURCE DE-EQUALIZATION**

**Source de-equalization (De-Eq) is only required if the source is equalized.**

*OEM sources (installed as standard by the car manufacturer) often have a high output level (speaker output) with preset equalization that can not be deleted.*

*By replacing the factory audio system (speakers and / or amplifiers), this equalization is harmful.*

*The bit Ten has an automatic procedure to verify equalization and, if present, can eliminate it.*

**1. Equalization analysis: setting the source.**

To run this procedure, follow the instructions as listed below:

- Disconnect the **bit Ten** RCA outputs (Front, Rear and Sub) if they are connected to the amplifiers.
- Play track 2 of the **bit Ten** CD.
- Set all tone and equalizer controls to zero (0).
- Set balance and fader to center (0).
- Don't change or reset the volume of the input sensitivity calibration ([see 6.1.3](#)).

If the calibration volume is lost, to find it simply proceed again as described in paragraphs [6.1.1 - 6.1.3](#) and verify that the IN LEVEL LEDs flash occasionally.

The DRC can display the calibration level, if your system has it ([see 10.2](#)).

**2. De-equalization analysis: setting the bit Ten.**

- Push the DE-EQ SET button and check the DE-EQ CHECK LED following the instructions in the following image.

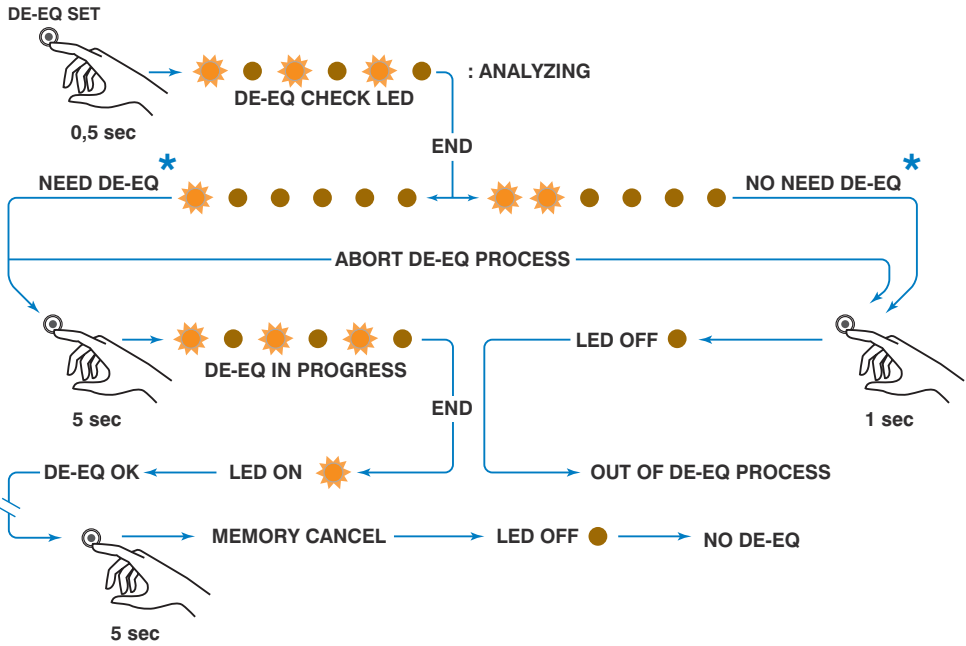
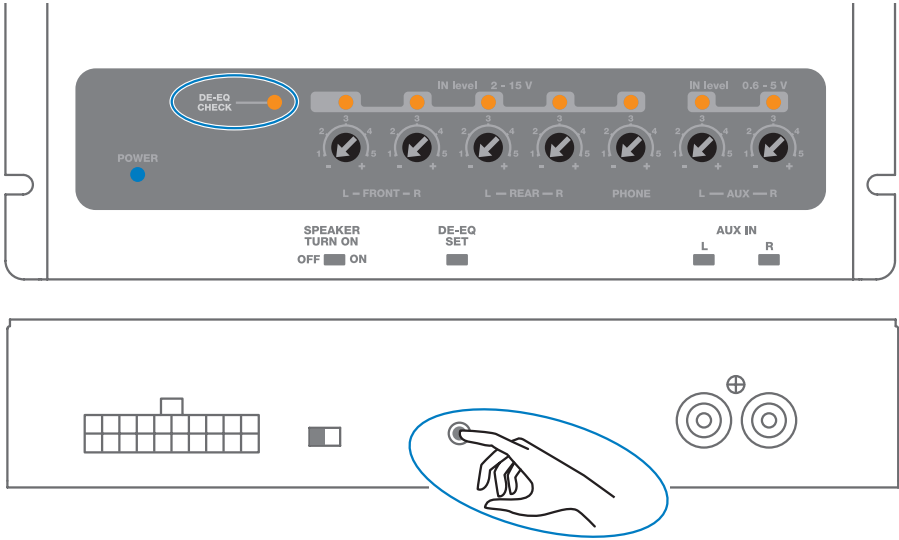

- The DE-EQ LED turns on to show that you recorded a de-equalization curve, otherwise it will be off.
- If the DE-EQ CHECK LED on the **bit Ten** is on, you can run the de-equalization procedure again. The new data will erase the ones previously stored.

**\*Important:** Confirm or abort the de-equalization process within 5 minutes, otherwise the bit Ten will automatically reset and turn off.



### 6.3 AMPLIFIERS SENSITIVITY CALIBRATION

Once the **bit Ten** input calibration or de-equalization (if any) procedures are complete, you can calibrate amplifiers sensitivity.

- Set the amplifiers crossover filters as desired and then connect them to the speakers.
- Connect the **bit Ten** PRE outputs (Front - Rear - Sub outputs) to the amplifiers inputs using high quality RCA cables.
- Set the amplifiers sensitivity of the various channels to about 4.0 Volts.

#### 1. Amplifiers sensitivity calibration by listening.

- Place the head unit volume where the **bit Ten** inputs were calibrated and play a highly dynamic track.
- Work on the amplifiers sensitivity controls slowly bringing them to higher sensitivity (less than 4.0 Volts). Once the first distortion symptoms show you should stop. This is easier if you work on one channel (stereo) at a time by disconnecting the other channels / amplifiers inputs.
- Once the amplifiers are calibrated, reconnect all the system channels and, if necessary, reduce the sensitivity (back to 4.0 Volts) of those channels that may have excessive volume.

#### 2. Amplifiers sensitivity instrument calibration.

For instrument analysis, you will need an oscilloscope.

- Disconnect all speakers from the amplifiers if already connected.
- Play track 1 of the **bit Ten** CD. All source controls must be flat (0).  
The volume control should be placed on the **bit Ten** input calibration level.
- Connect the oscilloscope to an amplifier output channel.  
The video will display a sine wave with variable frequency (sweep).
- Turn the sensitivity control in both directions until the sine wave looks slightly cut at both ends.
- Repeat for each amplifier channel.
- Reconnect the speakers and insert a CD with a music track.  
Reduce the sensitivity (by turning the knob toward 4.0 Volts) of those channels that may have excessive volume.

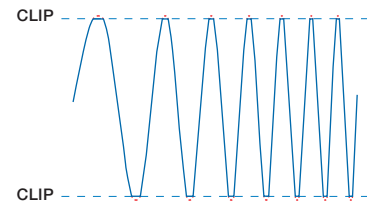

### 6.4 HOW TO CALIBRATE THE PHONE AND AUX IN INPUT SENSITIVITIES

Once the system is calibrated and fully working through the Front / Rear inputs, you can calibrate the PHONE and AUX IN inputs.

- **PHONE:** To use this input you need to connect a phone hands-free kit ([see 5.6](#)).  
Make a phone call, speak loudly and adjust the IN Level / PHONE knob until the LED flashes sporadically.
- **AUX IN:** To use this input you need to install the DRC (optional).  
Through the DRC select AUX ([see 10](#)).  
- If a source with a CD player is connected to the AUX input, disconnect the **bit Ten** outputs from the amplifiers and proceed as detailed in chapters [6.1.3 - 6.1.4](#).  
- If the source to be connected to the AUX IN input has no CD player (e.g. mp3 player), you can calibrate by listening.

**A** - Connect the **bit Ten** RCA inputs (AUX IN) to the head unit output.

**B** - Play a music track.

**C** - Turn the IN Level / AUX knobs until the first distortion symptoms appear. Check if the IN Level / AUX LEDs flash occasionally.



## 7. bit Ten SOFTWARE AND DRIVERS INSTALLATION / UNINSTALLATION GUIDE

### 7.1 PC SOFTWARE INSTALLATION GUIDE

1. Insert the “bit Ten Setup CD 1.0” CD-ROM into the CD player of the PC you are going to use.
2. **Windows XP:** select **My Computer** from the Windows **START** menu;  
**Windows Vista:** select **Computer** from the Windows **START** menu;  
**Windows 7:** select **Computer** from the Windows **START** menu;  
**Windows 8:** click on the **DESKTOP** icon;



Windows XP



Windows Vista

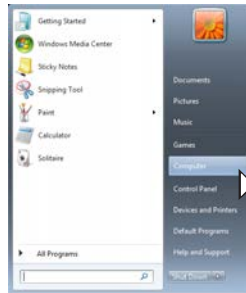

Windows 7



Windows 8

3. **Windows XP:** right-click the “bit Ten Setup CD 1.0” CD icon and click **Explore**;  
**Windows Vista:** right-click the “bit Ten Setup CD 1.0” CD icon and click **Explore**;  
**Windows 7:** right-click the “bit Ten Setup CD 1.0” CD icon and click **Open**;  
**Windows 8:** double click on the **Computer** icon.

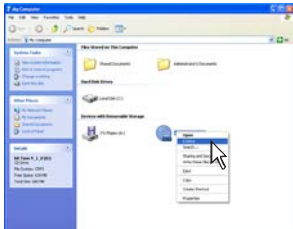

Windows XP

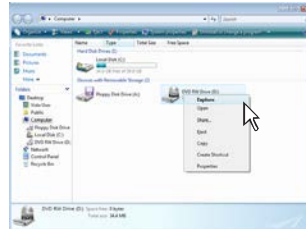

Windows Vista



Windows 7



Windows 8

4. **Windows XP:** double click the **Setup** icon;  
**Windows Vista:** double click the **Setup** icon;  
**Windows 7:** double click the **Setup** icon;  
**Windows 8:** select the CD ROM drive and double click on **setup** icon

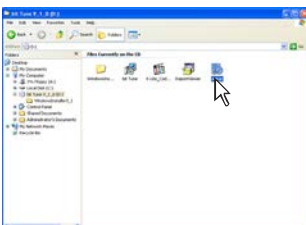

Windows XP

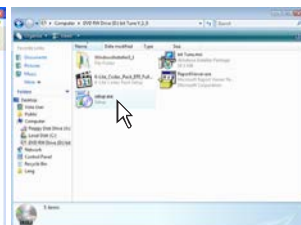

Windows Vista

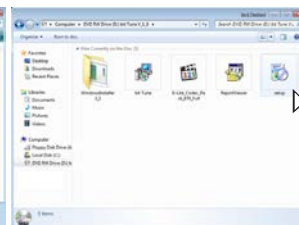

Windows 7

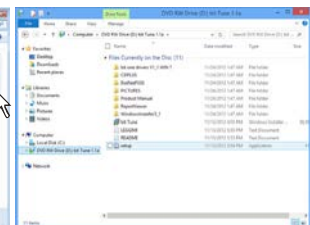

Windows 8

- 5. **Windows XP:** select **NEXT** to continue with the installation, **CANCEL** to interrupt it;
- Windows Vista:** select **NEXT** to continue with the installation, **CANCEL** to interrupt it;
- Windows 7:** select **NEXT** to continue with the installation, **CANCEL** to interrupt it;
- Windows 8:** select **NEXT** to go on with the installation, **CANCEL** to interrupt it;

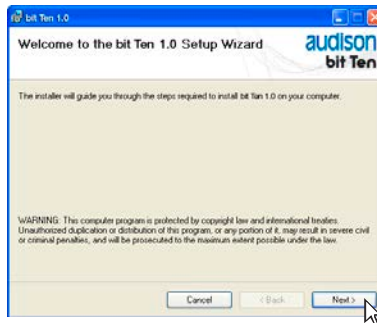

- 6. **Windows XP:** select **I Agree** and then **NEXT**;
- Windows Vista:** select **I Agree** and then **NEXT**;
- Windows 7:** select **I Agree** and then **NEXT**.
- Windows 8:** select **I Agree** and then **NEXT**;



- 7. **Windows XP: select;**
  - **Everyone** if you have system administrator privileges, so that, once installed, the program can be used by anyone who uses that PC;
  - **Just me** if you want that, once installed, the program can only be used by yourself as a single system user. Then click **NEXT**.
- Windows Vista: select**
  - **Everyone** if you have system administrator privileges, so that, once installed, the program can be used by anyone who uses that PC;
  - **Just me** if you want that, once installed, the program can only be used by yourself as a single system user. Then click **NEXT**.
- Windows 7: select**
  - **Everyone** if you have system administrator privileges, so that, once installed, the program can be used by anyone who uses that PC;
  - **Just me** if you want that, once installed, the program can only be used by yourself as a single system user. Then click **NEXT**.
- Windows 8: select**
  - **Everyone** if you have the system administrator privileges, so, once installed, the program can be used by anyone who uses that PC;
  - **Just me** if you want that, once installed, the program can only be used by yourself as single system user. Then click on **NEXT**;

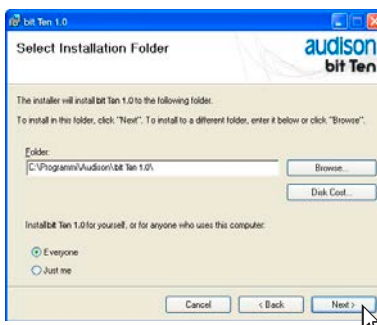

- 8. Windows XP:** complete the installation procedure, then click **CLOSE** to exit the installation;
- Windows Vista:** complete the installation procedure, then click **CLOSE** to exit the installation;
- Windows 7:** complete the installation procedure, then click **CLOSE** to exit the installation;
- Windows 8:** go on and complete the installation procedure, then click on **CLOSE** to exit the installation;



**7.2 DRIVERS INSTALLATION GUIDE**

- 1. Turn the **bit Ten** on.
- 2. Connect the USB cable to the appropriate port on the **bit Ten** and to an available USB slot on the PC.

**WARNING** When connecting a PC laptop via USB cable to the **bit Ten** while the device is turned on, the laptop has to work with its own battery and stay disconnected from the mains adapter (external power supply). Once the connection between the PC laptop and the **bit Ten** is established, you can immediately connect the computer, if necessary, to the mains adapter.

- 3. **Windows XP:** the PC will recognize the **bit Ten** interface and will automatically install the driver;



Windows XP

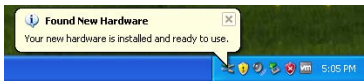

Windows XP

**Windows Vista:** the PC will recognize the **bit Ten** interface and will automatically install the driver;



Windows Vista



Windows Vista

**Windows 7:** the PC will recognize the **bit Ten** interface and will automatically install the driver;



Windows 7

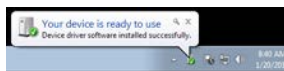

Windows 7

- 4. The peripheral device has been installed correctly and is ready for use.

**Remark:** The **bit Ten** uses HID drivers already integrated in Windows. For this reason, they are not included on the CD and will always install automatically.

### 7.3 bit Ten SOFTWARE UNINSTALL

#### Procedure 1

To uninstall the **bit Ten** PC software you can use the link listed on the following menu:  
Start / All Programs / bit Ten / uninstall.

#### Procedure 2

To uninstall the **bit Ten** PC software you can also follow the standard procedure:  
Start / Control Panel / Applications Installation / bit Ten / uninstall.

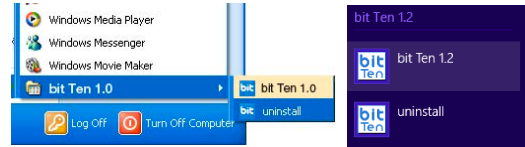

## 8. bit Ten INSTALLATION GUIDE USING A PC.

To configure the **bit Ten** inputs, outputs, equalizations and time delays, the processor must be connected to a PC after calibrating the input levels. At that point, you need to have in mind the system you want to realize, since from this moment if you want to change any of the settings, you will have to go through the guided procedure all over again.

More specifically the guided procedure will ask for:

- What kinds of specialization the main inputs channels use. The guided procedure changes according to your selection.
  - Which auxiliary inputs will be used (e.g. AUX and / or PHONE).
  - Which kind of signals will be allocated to the different outputs (e.g. Front Left, Center or Subwoofer etc.).
  - Which speakers you are using for your system (e.g. 2-way Front, Front / Rear, Sub etc.).
  - If the system features passive crossovers to manage speaker groups (e.g. 2-way system with active mid-low).
- During this procedure, you should disconnect the **bit Ten** output RCA plugs to the amplifiers.

### 8.1 SELECTING THE MASTER (FRONT / REAR) INPUTS AND OUTPUTS - TARGET MODE

1. Connect the head unit speaker outputs to the bit Ten high-level input (see 4.2).

Before turning on the system, make sure the amplifier's RCA plugs are disconnected from the bit Ten to avoid speaker damage during the calibration procedure.

The input calibration procedure must be performed with the ignition turned on. In this case, the car voltage is about 14.0 volts. The head unit will provide an undistorted output signal at higher volume.

2. Make sure that the IN Level knobs for the inputs used (L / R Front, L / R Rear, Phone, Aux IN L-R) are set to minimum sensitivity as in the figure (position -).



3. Turn on the **bit Ten** and connect the USB cable to a PC. After installing the **bit Ten** software, start it by clicking the icon previously created on the PC desktop.

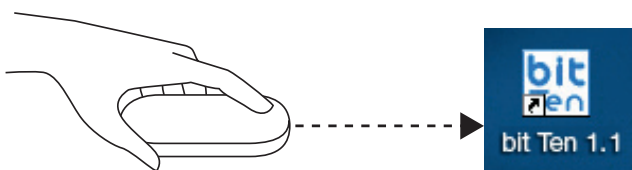

The first screen shown is the start page where you need to choose among three operational modes:



- **TARGET:** bit Ten D setup
- **OFFLINE bit Ten:** demo mode bit Ten (sel)
- **OFFLINE bit Ten D:** demo mode bit Ten D (sel)
- **RESCUE MODE:** Firmware upgrade recovery (sel)

Select the **Target (1)** start mode on the drop-down menu, then double click **(2)** on the **bit Ten** image or press ENTER.

- If synchronization is successful, a dialog box will show the data exchange between processor and software. Wait a few seconds and, finally, confirm by clicking the **OK** button.

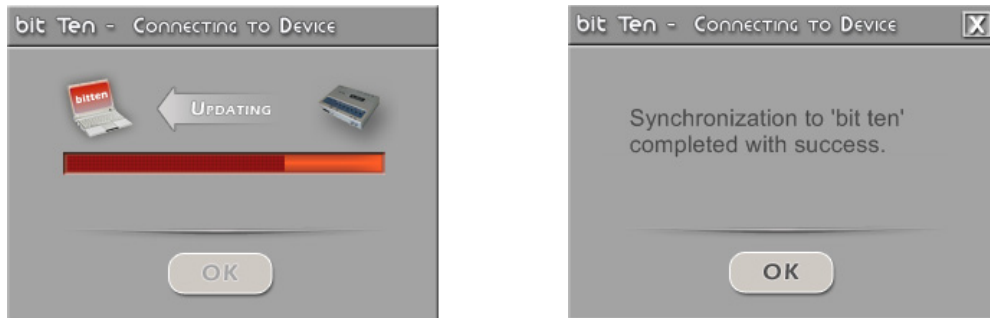

At this point you need to have in mind the system you want to realize beforehand, since from this moment if you want to change any of the settings you will have to go through the guided procedure all over again.

More specifically the guided procedure will ask for:

- Which auxiliary inputs will be used (e.g. AUX PHONE).
- Which kind of signals will be allocated to the main inputs (e.g. Front Left or Front Right etc.).
- Which speakers you are using for your system (e.g. 2-way Front + Sub etc.).
- If the system features passive crossovers managing speaker groups (e.g. 2-way system with active mid-low).

- Click the **Config** menu and select **I/O Configuration Wizard**.

Press **NEXT** to continue configuration.

Press **CANCEL** to exit.

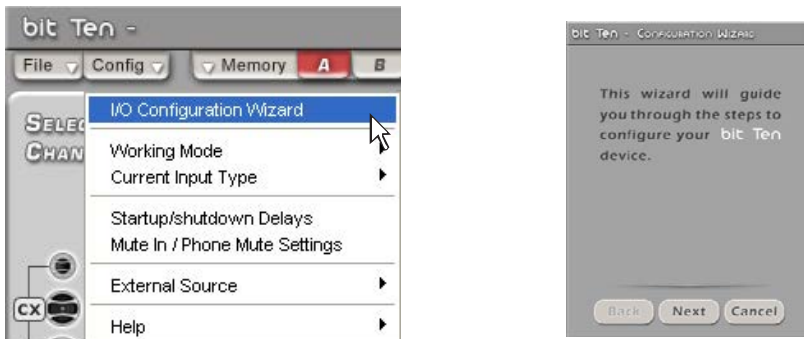

- Select the inputs.

Select among the auxiliary inputs, **AUX**, **PHONE**, those that will be used.

You can change this setting later on by selecting **Config / External Source** on the software main menu.

Press **BACK** to go back to the previous step.

Press **NEXT** to go ahead with the setup procedure.

Press **CANCEL** to exit the procedure.



**7. How to setup the Master high-level main inputs.**

You can assign any processor input channel the identifying name of the signal coming from the source.

The available names are: **FL** (Front Left Full); **FR** (Front Right Full); **RL** (Rear Left Full); **RR** (Rear Right Full); **FLTW** (Front Left Tweeter); **FRTW** (Front Right Tweeter); **FLW** (Front Left Woofer); **FRW** (Front Right Woofer); **Sub L** (Sub Left); **Sub R** (Sub Right).

The **bit Ten** will use these names to reconstruct a full range signal coming from an OEM source with a dedicated multi-channel amplifier and assign the corresponding signal to the respective analog output.

Press **BACK** to go back to the previous step.  
 Press **NEXT** to go ahead with the setup procedure.  
 Press **CANCEL** to exit the procedure.

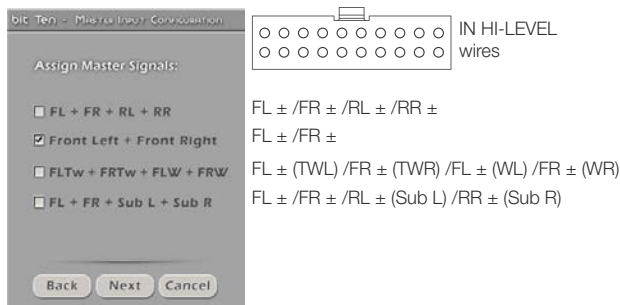

**8. Setting the source.**

- Turn on the system and play track 1 of the CD supplied with the **bit Ten**.
- Set all tone controls to zero (flat).
- Set balance and fader to center.
- Adjust the head unit volume to the maximum undistorted output level.
- If the source provides an adjustable equalizer, make sure that all controls are set to zero (flat).

Press **BACK** to go back to the previous step.  
 Press **NEXT** to go ahead with the setup procedure.  
 Press **CANCEL** to exit the procedure.

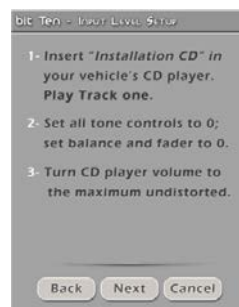

**WARNING** the head unit level must be elevated to the **maximum undistorted level**. If the head unit distortion level can not be tested in advance, bring the volume to approximately 80% of its maximum. If the head unit output level is set **too low**, the device will produce **ground noise** (hissing sound) when playing music tracks. This is due to the low signal / noise ratio provided by the **bit Ten** input head unit. If you have this problem, after you **calibrate the amplifiers sensitivity** (see 8.1.21), increase the head unit volume and **repeat the bit Ten calibration procedure** as detailed in the following chapter 9.

**Head unit input-level instrument check.**

You will need an oscilloscope for this instrument check.

- Connect the head unit output to the oscilloscope.
- Play track 1 of the **bit Ten** CD.
- Set tone, fader and balance controls and the equalizer (if any) to zero (flat).
- Turn on the car.
- Adjust the volume control so that the oscilloscope shows a sine wave with slightly cut peaks, as shown in the figure.
- Note the volume used by the head unit. It must be left in this position for the following operations.

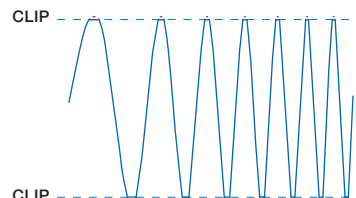

**9. How to calibrate the bit Ten IN Level inputs.**

This procedure is delicate and requires particular attention. Improper execution can invalidate the final acoustic results.

**The bit Ten outputs must be disconnected from the amplifiers.**

- While playing track 1 of the CD, turn the first knob towards the highest sensitivity (position +).
- When the orange LED lights up or flashes, stop turning and go back slightly until the LED turns off.

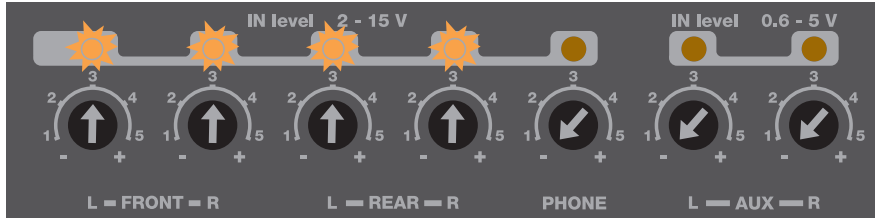

- It is normal for the LED to flash briefly; this indicate correct sensitivity calibration.
- Repeat the procedure for the other 3 Front / Rear knobs.
- Note the calibration level used by the head unit volume control.

**Important:** Some factory head units require a low load impedance to enable the outputs (usually the Rear section). If during the calibration process the input signal level can't be adjusted, it could be necessary to connect in parallel a 47Ω - 3W resistor to the input cables of the channels showing the issue.



Press **BACK** to go back to the previous step.  
 Press **NEXT** to go ahead with the setup procedure.  
 Press **CANCEL** to exit the procedure.

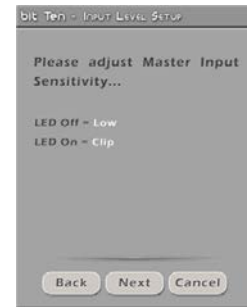

**WARNING:** Audio systems installed as standard by car manufacturers often come with equalized outputs. This means that the response curve is not flat and the difference between the highest and the lowest level can reach 6 dB. By calibrating the device so that the LED never lights up, the bit Ten sensitivity may be suboptimal (low) and you may experience noise (whistle) on the speakers. A few quick LED flashes indicate only a small distortion when handling maximum peaks (very occasional) of music tracks. If the source is not equalized, response is flat and the LEDs will always be on or always off. In this case, calibrating is easy because you will simply need to adjust the knobs so that the LEDs turn off just below the point they turn on.



**10. How to select the speakers available in the system.**

Speakers can be selected just by clicking on them. If the left tweeter, left midrange or left woofer are selected, the software provides the ability to automatically also activate the right tweeter, right midrange or right woofer. Once started, this choice sets the dedicated crossover type and frequencies with default settings. If you do not use passive crossover filters, each speaker corresponds to an output channel. The bit Ten has 5 output channels; not using passive crossover filters allows you to pilot 5 amplified channels. Of course you can select more than 5 speakers, in which case the system will help implement passive crossovers.

Press **BACK** to go back to the previous step.  
 Press **NEXT** to go ahead with the setup procedure.  
 Press **CANCEL** to exit the procedure.

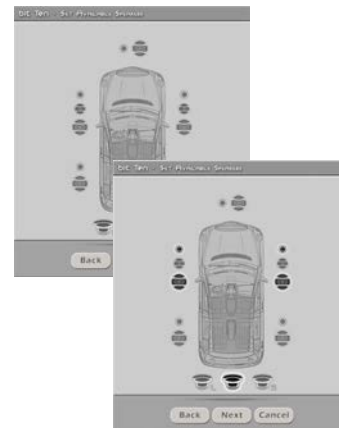



**11. How to select passive crossovers for speaker groups.**

You can set if passive crossovers exist that manage speaker functional groups.

**Eg.:** If the audio system has passive crossovers, the software will ask you to set them, otherwise press NEXT. A 2 or 3-way passive crossover only takes a single channel. If the sum of crossovers and / or speakers exceeds 5 output channels, the software won't allow you to continue. Recheck the crossover setting or, by BACK, the speaker configuration.

**WARNING:** A coaxial speaker should be considered  a Tweeter + Woofer + 2-way Crossover.

Press **BACK** to go back to the previous step.  
 Press **NEXT** to go ahead with the setup procedure.  
 Press **CANCEL** to exit the procedure.

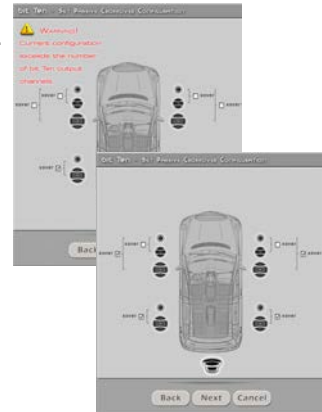

**12. Processor outputs (Ch1÷Ch5) allocation.**

The **bit Ten** features 5 output channels. The software will automatically assign a number from 1 to 5 to each crossover or speaker.

The numbers match the corresponding output channels (e.g. 3=CH3).

With **DEFAULT** settings, you will have: **CH1**=Front L; **CH2**=Front R; **CH3**= Rear L; **CH4**= Rear R; **CH5**= Sub.

Automatic numbering can be adjusted using the cursors next to the numbers.

In case a number is repeated or incorrect an error message will be shown.

To then check if the channel number and the actual name (e.g. 3=CH3 -> Rear L) are consistent, open the **CHANNEL MAP** [\(see 8.8\)](#).

Press **BACK** to go back to the previous step.  
 Press **NEXT** to go ahead with the setup procedure.  
 Press **CANCEL** to exit the procedure.

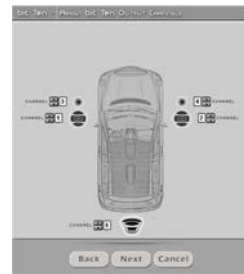

**13. Source equalization analysis.**

*Source de-equalization (De-Eq) is only required if the source is equalized. OEM sources (installed as standard by the car manufacturer) often have a high output level (speaker output) with preset equalization that can not be deleted. By replacing the factory audio system (speakers and / or amplifiers), this equalization is harmful.*

*The bit Ten has an automatic procedure to verify equalization and, if present, can eliminate it.*

Press **BACK** to go back to the previous step.  
 Press **NEXT** to go ahead with the setup procedure.  
 Press **CANCEL** to exit the procedure.

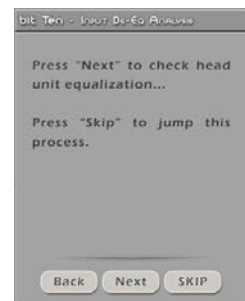

**14. Equalization analysis: setting the source.**

To run this procedure, follow the instructions as listed below:

- Disconnect all the **bit Ten** RCA outputs (Front, Rear, Sub) if already connected to the amplifiers.
- Play track 2 of the **bit Ten** CD.
- Set all tone and equalizer controls to zero (0).
- Set balance and fader to center (0).

If the calibration volume is lost, to find it simply proceed again as described in paragraphs [8.1.8 - 8.1.9](#) and verify that the IN LEVEL LEDs flash occasionally. The DRC can display the calibration level, if your system has it [\(see 10.2\)](#).

Press **BACK** to go back to the previous step.  
 Press **NEXT** to go ahead with the setup procedure.  
 Press **CANCEL** to exit the procedure.

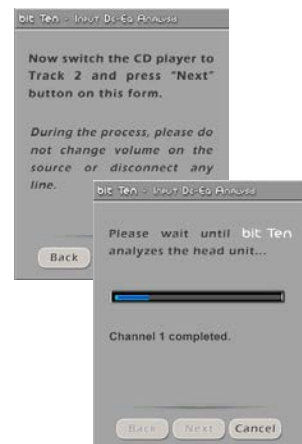

**15.** Once analysis has completed, the following messages could be displayed:

- **Head unit is equalized:** The head unit is equalized, so we recommend to de-equalize the signal afterwards.
- **Head unit is not equalized:** The head unit is not equalized, so you don't need to de-equalize the signal afterwards.

Press **BACK** to go back to the previous step.  
 Press **NEXT** to go ahead with the setup procedure.  
 Press **CANCEL** to exit the procedure.



**16. Source de-equalization.**

Press **BACK** to go back to the previous step.  
 Press **NEXT** to go ahead with the de-equalization.  
 Press **SKIP** to skip the de-equalization procedure and proceed to point 19.

**Important:** Confirm or skip the de-equalization process within 5 minutes, otherwise the bit Ten will automatically reset and turn off.



**17. Running the de-equalization procedure.**

If you decide to run the procedure, follow the instructions as listed below:

- Play track 2 of the **bit Ten** Setup CD (press Play);
- Set all source tone controls to zero (0);
- Set source balance and fader to center (0);
- Don't change the source volume level previously set through the input calibration.

Press **BACK** to go back to the previous step.  
 Press **NEXT** to go ahead with the de-equalization.  
 Press **CANCEL** to exit the procedure.

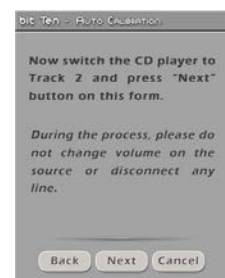

**18.** Through a real-time progress bar and specific messages, the software shows how the procedure is being executed. Once the procedure is complete, you will see **“Press Next to Continue”**.

Press **BACK** to go back to the previous step.  
 Press **NEXT** to go ahead with the setup procedure.  
 Press **CANCEL** to exit the procedure.

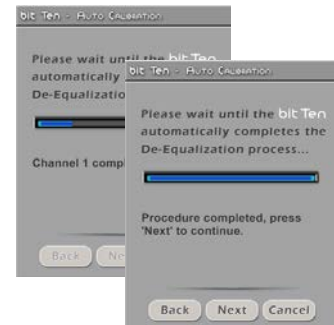

**19. System configuration successfully completed.**

Stop playing the Test track, remove the supplied Setup CD from the CD player of your head unit and then click **OK**.

Once the de-equalization is complete, the **bit Ten** DE-EQ CHECK LED will turn on indicating that you have recorded a curve. If you were to repeat the de-equalization, new data will replace the previous ones. To clear the memory and turn the DE-EQ CHECK LED off [see 6.1.2](#).



**20. Software Startup.**

The settings selected during the guided procedure are transferred to the processor main memory. Once this operation is complete, a message confirming that the update has been done will be displayed.

Press **OK**.

We recommend that you finalize the product and avoid losing data stored during calibration ([see 8.5.3](#)) with the **FINALIZE TO bit Ten** function, from the main **FILE** menu.

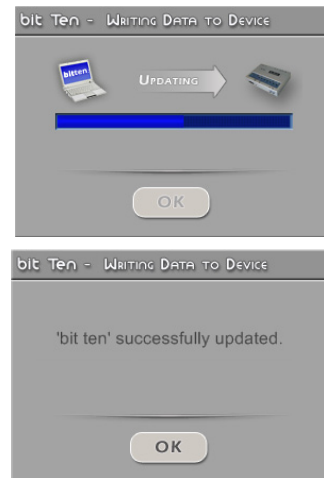

**21. Amplifiers sensitivity calibration.**

Once the **bit Ten** input calibration or De-Equalization (if any) procedures are complete, you can calibrate amplifier's sensitivity. If you proceed according to the following procedure, you will achieve the best acoustics results, also eliminating any possible background noise.

1. Connect the different amplifiers channels to the speakers.
2. Connect the bit Ten PRE outputs (OUTPUT: Front - Rear - Sub / CHI -> CH5) to the amplifiers inputs using high quality RCA cables.
3. Set the amplifiers sensitivity of the various channels to about 4.0 Volts. Then proceed according to either of the two following procedures:

**A. Amplifiers sensitivity calibration by listening.**

- Place the head unit volume where the **bit Ten** inputs were calibrated and play a highly dynamic track.
- Work on the amplifiers sensitivity controls slowly bringing them to higher sensitivity (less than 4.0 Volts). Once the first distortion symptoms show you should stop. This is easier if you work on one channel (stereo) at a time by disconnecting the other channels / amplifiers inputs.
- Once the amplifiers are calibrated, reconnect all the system channels and, if necessary, reduce the sensitivity (back to 4.0 volts) of those channels that may have excessive volume.

**B. Amplifiers sensitivity instrument calibration.**

For instrument analysis, you will need an oscilloscope.

- Disconnect all speakers from the amplifiers if already connected.
- Play track 1 of the **bit Ten** CD. All source controls must be flat (0).

The volume control should be placed on the **bit Ten** input calibration level.

- Connect the oscilloscope to an amplifier output channel. The video will display a sine wave with variable frequency (sweep).

- Turn the sensitivity control in both directions until the sine wave looks slightly cut at both ends.
- Repeat for each amplifier channel.
- Reconnect the speakers and insert a CD with a music track. Reduce the sensitivity (by turning the knob toward 4.0 volts) of those channels that may have excessive volume.

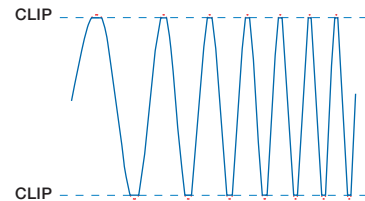

4. The flattening of the functional groups acoustic intensity obtained through the amplifiers sensitivity calibration is an approximate adjustment. The **bit Ten** applies the standard settings by default. After the acoustic settings described in the following paragraphs are performed, you will be able to refine the functional groups acoustic flattening by acting on the **bit Ten** outputs ([see 8.13](#)).

**22. How to calibrate the Phone and Aux Ininput sensitivity.**

Once the system is calibrated and fully working through the Front / Rear inputs, you can calibrate the PHONE and AUX IN inputs.

- **PHONE:** To use this input you need to connect a phone hands-free kit [\(see 5.6\)](#).  
Make a phone call, speak loudly and adjust the IN Level / PHONE knob until the LED flashes sporadically.
- **AUX IN:** To use this input you need to install the DRC (optional).  
Through the DRC select AUX [\(see 10\)](#).
- If a source with a CD player is connected to the AUX input, disconnect the **bit Ten** outputs from the amplifiers and proceed as detailed in chapters [6.1.3 - 6.1.4](#).
- If the source to be connected to the AUX IN input has no CD player (e.g. mp3 player), you can calibrate by listening.

- A** - Connect the **bit Ten** RCA inputs (AUX IN) to the head unit output.
- B** - Play a music track.
- C** - Turn the IN Level / AUX knobs until the first distortion symptoms appear. Check if the IN Level / AUX LEDs flash occasionally.

**8.2 OFFLINE MODE**

In this mode, even if the **bit Ten** processor is connected to the PC, it does not interact with the software. The **OFFLINE** mode [\(see 8.1.3\)](#) can be used to work on the software without connecting the **bit Ten** to the PC to get familiar with the multiple processor functions or to save settings that can be used later [\(see 8.5.1\)](#).

The software is pre-set to start with a FRONT +REAR + SUB multi-amplified system.

To set a new "virtual" system, and so to change the inputs and select the outputs, you need to select the function **I/O Configuration Wizard** in the **Config** window of the software main menu. Follow the same instructions as those for the **TARGET** mode [\(see 8.1.5\)](#).

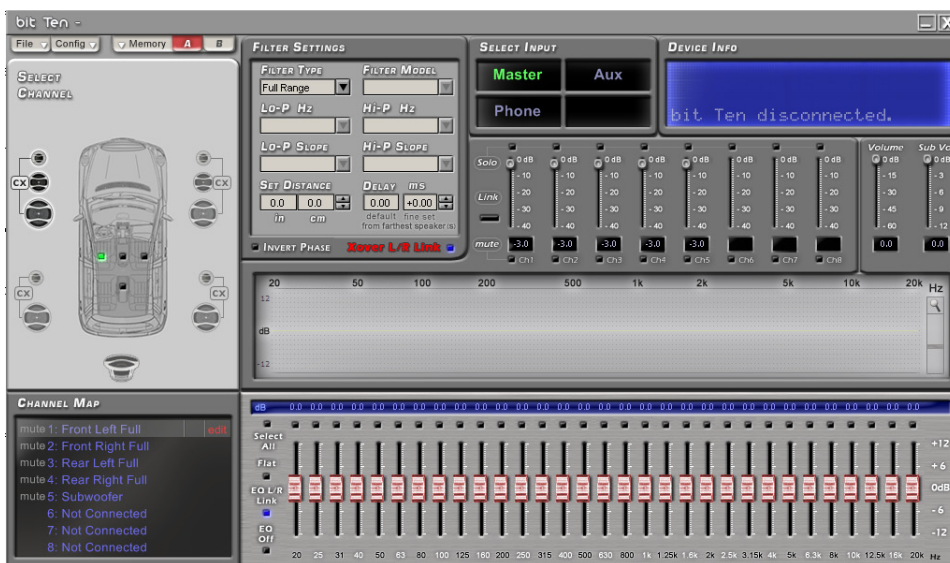

Here is how the **bit Ten** software appears when started in **OFFLINE** mode.

### 8.3 ADJUSTING ACOUSTIC REPRODUCTION

The following chapters detail the system adjustments and acoustic tuning features.

**WARNING:** We recommend that you do not modify the settings of your **bit Ten** to explore its features. Take your time to get familiar with the possibilities this software offers. If you decide to leave the amplifiers connected to the **bit Ten**, remember to perform the adjustments keeping the general volume at a level that does not damage the speakers in your system.

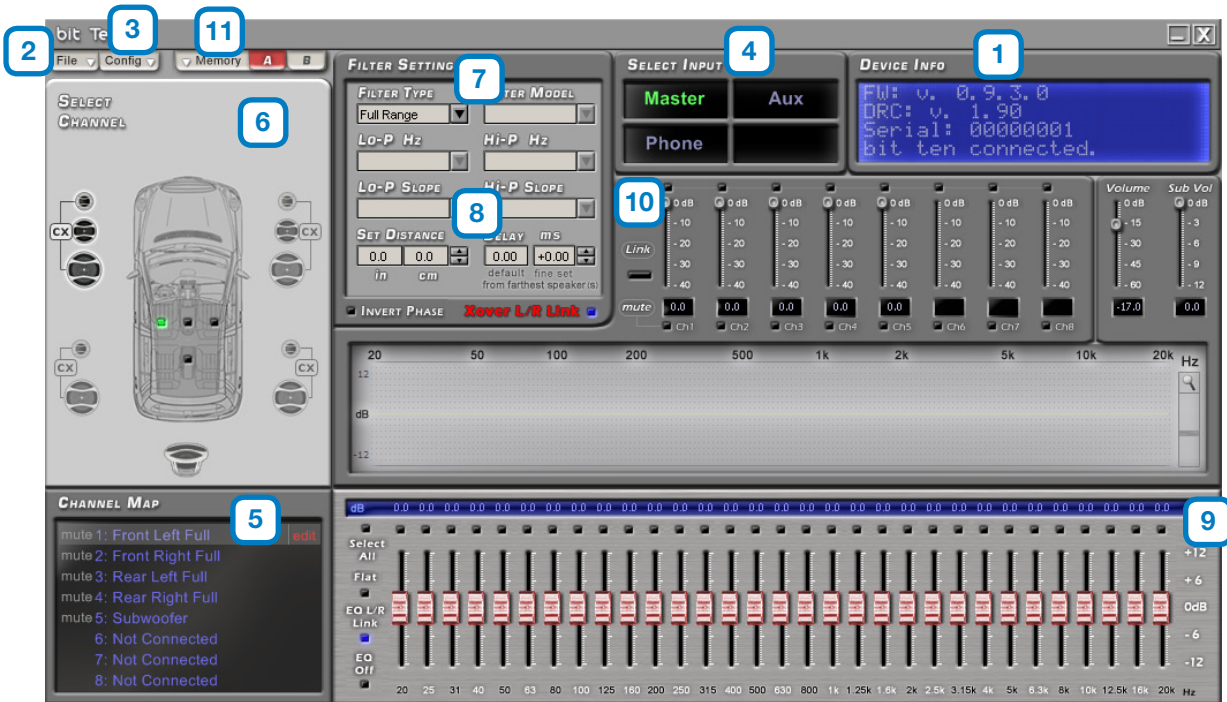

### 8.4 DEVICE INFO

This window indicates whether the **bit Ten** is correctly connected to the PC and the DRC. It also shows the device Firmware version.

### 8.5 "FILE" MAIN MENU

Clicking the File tab, a drop-down menu appears with the entries shown in the image:

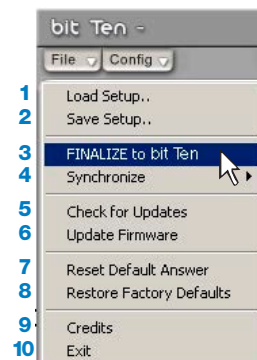

- 1. Load Setup:** the entire **bit Ten** configuration is loaded from a previously saved file (e.g. "bitTenConfig.dip"). This feature is available both in **TARGET** and in **OFF LINE** mode. In **TARGET** mode, this lets you load all the settings that have been previously saved. This is useful if you want to resume all the settings you previously selected to install another **bit Ten** with the same settings. Output levels calibration and de-equalization, if any, must be repeated. In **OFFLINE** mode, this lets you view the features you previously saved.



**2. Save Setup:** saves the entire **bit Ten** configuration in a file (e.g. "bitTenConfig.dip") that you can load again to the **bit Ten** a second time through the **Load Setup** function. This feature is available both in **TARGET** and in **OFF LINE** modes.

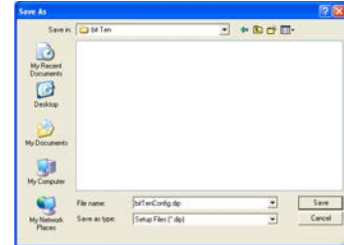

**3. FINALIZE to bit Ten:** loads all the parameters selected while configuring the **bit Ten** into the internal memory, allowing it to work without being connected to a PC. When selecting the **Finalize to bit Ten** function, the software notifies you that the data previously saved to the **bit Ten** will be overwritten.

- Click **YES** to load the data.
- Click **NO** to interrupt the process.

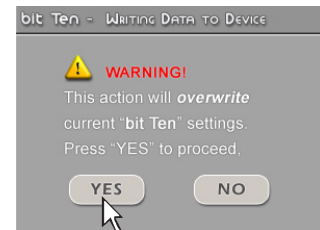

**WARNING:** Before disconnecting the **bit Ten** from the PC or each time that you exit the PC Software after modifying the system configuration, always run the **Finalize to bit Ten** procedure. If you do not follow these instructions, all data entered will be lost and the device will use the previous settings.



**4 Synchronize: PC -> bit Ten, PC <- bit Ten**

These functions synchronize the PC with the **bit Ten**. If a dialog box like the one on the right appears, it means that for some reason communication between the PC and the **bit Ten** has been interrupted. To restore the communication, click:

- **PC -> bit Ten.** The PC loads into the **bit Ten** the settings that have been selected so far.
- **PC <- bit Ten.** The PC loads the settings that have been previously stored in the bit Ten.



**WARNING:** This operation cannot guarantee that data are always retrieved. If, once you run it, the operation is not successful, you need to:

1. exit the **bit Ten** software;
2. turn the **bit Ten** off;
3. turn the **bit Ten** on;
4. launch the **bit Ten** software again.

Synchronization will be restored but the selected settings will be lost.



**5 Check for updates:** connects to the web site <http://update.audison.eu> and checks if any software / firmware updates to the **bit Ten** and DRC are available, in order to update the devices you are using (see 9.3 - 10.4). To perform this operation, your PC has to be connected to the internet.

**6. Update Firmware:** select to update the **bit Ten** firmware (see 10.3).

**7. Reset Default Answer:** restores the display of warning messages if they have been disabled by checking "**Don't show me again**".

**8. Restore Factory Defaults:** entirely resets the **bit Ten** back to its default settings, cancelling all data previously saved in the processor.

**9. Credits:** shows information about the **bit Ten** software in use.

**10.Exit:** exits the PC software.

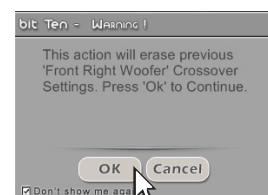

**8.6 “CONFIG” MAIN MENU** 3

If you click on the **Config** tab, a drop-down menu appears listing the entries shown in the image on the right:

1. **I/O Configuration Wizard:** sets up the system and puts the **bit Ten** in the required conditions [\(see 8.1.5\)](#).
2. **Working Mode - Standard Expert:** the software can work in two modes, acting on the crossover filter.
  - **Standard:** simplified mode with some restrictions easing the use of the software [\(see 8.10\)](#).
  - **Expert:** does not have any restrictions in the use of the software [\(see 8.10\)](#).  
We suggest to try and use the software in **Expert** mode; if it is too difficult, change to **Standard** mode.
3. **Current Input Type:** shows the specialization assigned to the MASTER inputs.
4. **Start up/Shutdown delays:** allows you to change the **bit Ten** turn on / off time settings.
  - **StartUp Time:** is the delay between turning the device on and audio output. Every amplifier exhibits, while turning on, its own delay before being operational. If you set Startup Time to a value greater than or equal to the longest of these delays, the entire audio system will be synchronized.
  - **Shutdown time:** is the delay between turning the REMOTE OUT signal off for the amplifiers and turning the bit Ten off. It is generally not necessary to change this parameter, but can be decreased if your amplifiers produce a “Bump” when shut down.
5. **Mute In / Phone Mute settings:** allows you to specialize the “MUTE IN / PHONE MUTE” terminals (default settings) for the AUX input to be automatically selected. If you choose to use the “MUTE IN” terminal, it will be active if you apply + 12V to it. If you choose to use the “PHONE MUTE” terminal, instead, it will be active if you apply GND to it. According to the chosen setting modification, the corresponding default function will be disabled.
6. **External source:** provides the ability to enable or disable auxiliary sources selected or left out of the I/O configuration Wizard [\(see 8.1.4\)](#).

7. **Help:** activating it by clicking on “**Active**”, it allows to display the context messages regarding the software section in use. Different languages connected to the context messages can be selected from a drop-down menu.

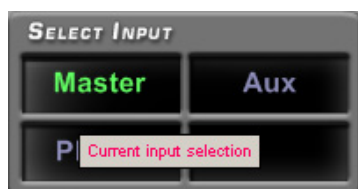
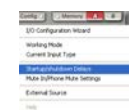
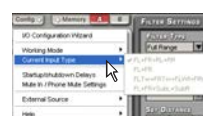
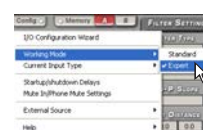
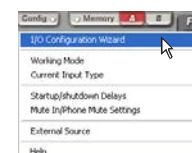

**8.7 SELECTED INPUT** 4

The **Selected Input** window shows the source that is active while the **bit Ten** is connected to the PC. You can select the desired source by clicking it. Once the **bit Ten** has been disconnected from the PC, you can select the **bit Ten** input source through the DRC [\(see 10\)](#).



**8.8 CHANNEL MAP** 5

This window displays the names given to the output channels. When this window is active, you can manage each channel that, once selected, will be highlighted. Press the CTRL key and click another channel to select and highlight it as well. The filter curve will appear on the graph at the same time. Multiple selection is only allowed for functional groups, except for the Subwoofer that can be selected with any group.

E.g. Front Left Full can be selected with Subwoofer but not with Rear Left Full. If you want to check the Rear + Subwoofer system, you have to de-select the Front system.

The software only allows you to work on a single channel and will display the word EDIT in red next to the corresponding channel.

In particular, the graph will display a red line for only the electrical response of the crossover corresponding to the editing channel, a blue line for the overall electrical response of all selected channels, taking into account the crossover filters and equalizations, and a green line for the final result.

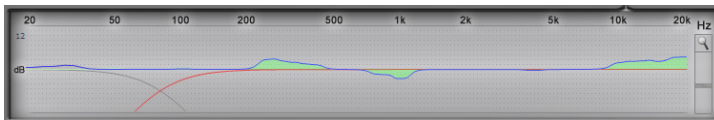
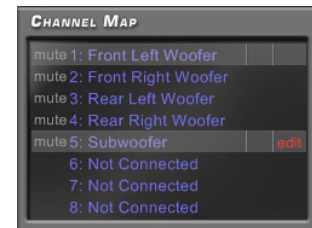

To act on another channel and keep your selection, click to the right of the desired channel, where the EDIT column is.

The CHANNEL MAP window also lets you silence each channel by clicking on the word MUTE to the left of the desired channel.

If MUTE is on, the word gets highlighted in green.

You can also select a channel as shown in the image next to the following chapter 8.9.

**8.9 SELECT CHANNEL** 6

This window is active. You can click the speakers or the speaker system to manage each single channel that, once selected, will be shown highlighted. If you keep the CTRL key pressed and click on another channel, this other channel will be selected and highlighted as well, similarly to what happens with the Channel Map [\(see 8.8\)](#).

**Listening point visual indicator**

The Select Channel window includes this function as well (shown in green).

Four points are pre-set: driver, passenger, front center and rear center for the corresponding passengers.

This indication acts only and exclusively as a reference for the digital delay automated calculation [\(see 8.11\)](#). If delays are set according to the “driver” position and then you want to optimize the system also for the “passenger” position, you need to set the distances through the specific menu [\(see 8.11\)](#) again, as the system doesn’t update them automatically.

If used together with the presets [\(see 8.14\)](#), it is useful to try different setups according to the different listening points.

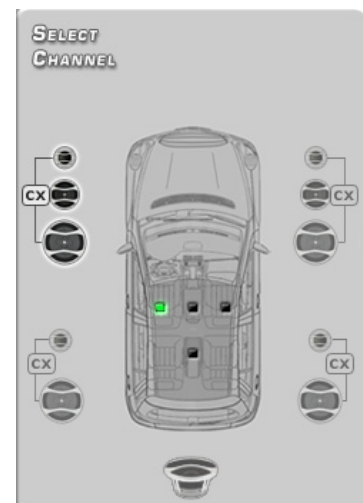



## 8.10 FILTER SETTINGS 7

The **bit Ten** has five crossover filters, one per each output channel. Each filter allows you to set the parameters of a single output channel.

1. **Xover L/R Link:** modifications applied to one of the channels (right or left) will also automatically be applied to the other one. To do so, click on the blue flashing light. **Xover L/R Link** affects all Filter Setting adjustments except **Set Distance (Delay)**.
2. **Invert Phase:** inverts the phase of the channel under examination by 180°. This can be done by selecting the green light which will turn on. This can be useful to solve phase alignment problems among the different filtered channels.
3. **Filter Type:** lets you select the different types of filters that can be assigned to channels:
  - Full Range
  - Low Pass
  - High Pass
  - Band Pass

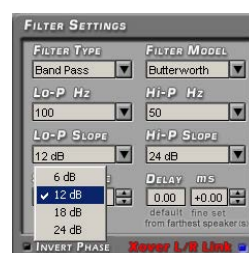
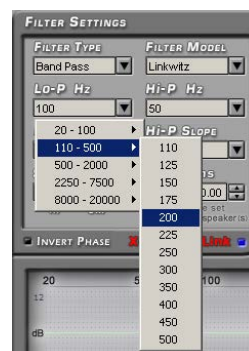

### In STANDARD mode:

According to the speaker or speaker system selected during setup, suitable filter types will be available.

**E.g.** for the Front Woofer only Low Pass or Band Pass will be available. For the Front Mid-Hi only High Pass and Band Pass will be available, etc.

### STANDARD MODE

FILTER TYPE ->	Full Range	Low Pass	High Pass	Band Pass
Tweeter			X	X
Midrange				X
Woofer		X		X
Mid-Hi			X	X
Subwoofer		X		X
Full	X	X	X	X

### In EXPERT mode:

Every speaker system selected has every filter type available.

### EXPERT MODE

FILTER TYPE ->	Full Range	Low Pass	High Pass	Band Pass
Tweeter	X	X	X	X
Midrange	X	X	X	X
Woofer	X	X	X	X
Mid-Hi	X	X	X	X
Subwoofer	X	X	X	X
Full	X	X	X	X

**WARNING:** In EXPERT mode, pay due attention to the filter selection. Speakers have mechanical limits that must not be exceeded, otherwise they could lead to permanent damage. When you select a filter, some optimized cut-off frequencies are set by default to avoid breaking the speakers.



**E.g.** if you select Low Pass for a tweeter, the default frequency is suitable for a woofer but not for the tweeter, which may be damaged.

4. **Filter Model:** lets you select the type of filter to be applied.
  - Linkwitz (default)
  - Butterworth

When launching the **bit Ten** software, it suggests Linkwitz as the standard filter model for the speaker or speaker group connected to the corresponding channel.

To apply the opposite (Left / Right), turn the Xover L/R Link on.

If you modify the model to Butterworth, the change will be applied to both.

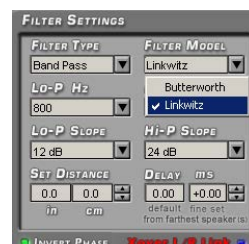

### 5. Cut-off frequencies

- **Hi-P Hz**     10 ÷ 20000: filter High-Pass
- **Lo-P Hz**     10 ÷ 20000: filter Low-Pass

If you select the Band-Pass filter, both Hi-P Hz and Lo-P Hz boxes will be available to set the band frequency.

You can select the cut-off frequency by:

- clicking on the corresponding drop-down menu, selecting the frequency range that includes the value to be set, and then the actual value;
- clicking on the corresponding drop-down menu, selecting the frequency range and then moving from value to value with the arrow keys (up / down) on the PC keyboard;
- clicking on the corresponding drop-down menu and then moving from value to value with a mouse featuring a rotating scroll wheel.

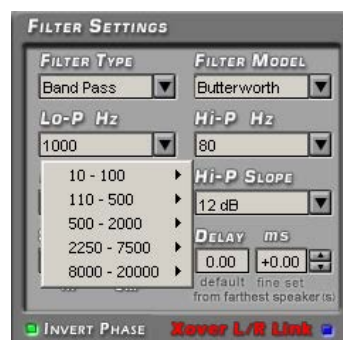

In **STANDARD mode** the crossing frequency for speakers of the same front is bound with a -3 dB crossover.

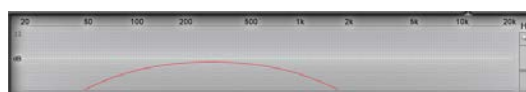

**E.g.** If you change the Front Woofer low pass cut-off frequency, the Front Mid-Hi hi-pass cut-off frequency will also automatically change. If you change the Subwoofer low-pass cut-off frequency, instead, the Front Woofer hi-pass cut-off frequency won't change.

In **EXPERT mode** the crossing frequency for speakers of the same front is free, meaning that cut-offs can be created with a value other than -3 dB.



### 6. Filter slope

- **Hi-P Slope** 12/24 dB/Oct (Linkwitz) 6/12/18/24dB/Oct (Butterworth)
  - **Lo-P Slope** 12/24 dB/Oct (Linkwitz) 6/12/18/24 dB/Oct (Butterworth)
- When starting the **bit Ten** software, it offers Linkwitz with 12 dB/Oct. slope.

**Eg.** If you select Band Pass as filter type, the slope will be applied to both hi-pass and low-pass as the default slope, but it is also possible to unbind them.

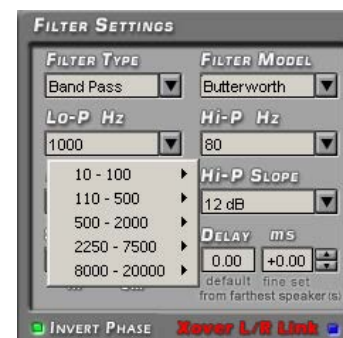

The crossover filter response corresponding to the selected channel is displayed on the graph by a red curve, as in the examples below.

Eg.: Band Pass



Crossover Frequency 80 - 2000 Hz @ 12 dB/Oct.



Crossover Frequency 80 Hz @ 6 dB/Oct. Hi-pass  
2000 Hz @ 24dB/Oct. Low-pass



Crossover Frequency 80 - 2000 Hz @ 24 dB/Oct.



Crossover Frequency 80 Hz @ 24 dB/Oct. Hi-pass  
2000 Hz @ 6 dB/Oct. Low-pass

**8.11 SET DISTANCE AND DELAY** 8

This setting automatically calculates the time speaker sound takes to get to the listener's ear (Fig. 1).

**Preliminary Remarks**

Sound moves through the air at a speed of 343 mt/sec (1.125 ft/sec) at a temperature of 20°C (68°F). If you know the distance from the sound emission point, you can then calculate the time sound takes to get to the listener's ear. If you set the distances of the different speakers in your system, the **bit Ten** will automatically change them into time (ms - milliseconds). It does not assign a delay (0.0 ms) to the farthest speaker (usually the Subwoofer) but progressively growing delays as much as the other speakers get closer to the listening point, in order for all the emission points to reach the listening point at the same time.

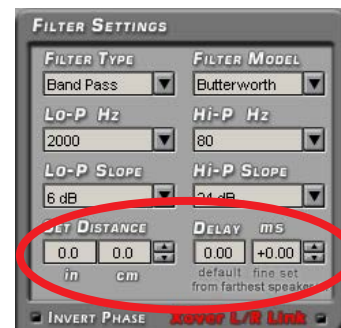

Fig. 1

**SET DISTANCE**

Lets you set the distance between the speaker and the listening point. Choose cm (centimeters) or in (inches). The **Set Distance** boxes can be set using the cursors or by typing the numbers on the keyboard.

**DELAY ms/default**

Displays the time in ms (milliseconds) calculated according to the distance.

**DELAY ms/fine set**

The **bit Ten** time delays also let you perform manual fine-adjustment.

**Preliminary Remarks**

**Fine Set and Phase Delay**

Delay assignment according to distance calculation is theoretical. That is, small variations need to be applied due to small errors in distance measurement, back-wave reflections inside the car compartment and, mainly, the speaker phase problem.

Two speakers reproducing two areas of frequency close to each other (e.g. Woofer and Midrange) will simultaneously reproduce in their crossing area, at attenuated level, the same frequencies. Due to the different nature of the speakers, they will show a difference in phase that, for a short frequency interval, works like a time delay. By using **Fine Set** you can partly correct these problems of **Phase Delay**.

By using **Fine Set** you can change the automatically set time delay. This delay adds to (+ x.xx) or is deducted from (- x.xx) the value of the delay shown in the **Delay / Default** window, and does not change the value automatically calculated. Assigning a positive value (+ x.xx) with **Fine Delay** means increasing the delay of that speaker and thereby takes it closer to the listening point. Likewise, assigning a negative value (- x.xx) means decreasing the speaker delay and therefore moves it further away from the listening point.

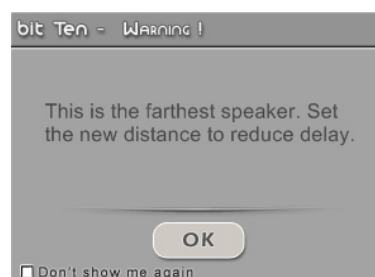

Fig. 2

In order for you to see how much **Fine Set** has been manually changed, both delay values are shown. To see the result applied to the output, you have to add the values shown in the **Delay / Default** and **Delay / Fine Set** boxes. A negative value (decreasing the delay) can not be assigned to the farthest speaker; it can only be assigned to the other speakers as they are all already delayed compared to the farthest one. If you try and give a negative value to the farthest speaker, an alert message will appear (Fig. 2). When using **Fine Set**, the letters **Fds** will be shown in green on the corresponding channel of the **Channel Map** (Fig.3).



Fig. 3

**Example of setting the time delay (Fig.4):**

1. Choose the system listening point.  
To identify the listening point, choose an ideal point located at the center of the listener's (driver or passenger) head.  
For the front center and rear center points choose an intermediate point between the two (left / right) listeners.
2. Measure the distance between each speaker or group of speakers and the listening point in a straight line ("as the crow flies").  
For each speaker choose the center of the mobile membrane as the emission point.  
For groups of speakers choose an intermediate point between them. It will then be possible to perform fine tuning by using the Fine Set function. (fig.6)
3. Select the channel related to the speaker under examination on the Channel Map and enter the respective distance value in the Set Distance box of the Filter Settings menu. (fig.5)
4. Repeat step 3 for each channel.
5. Perform all time delays settings, start playing music and select the Fine Set box. As you move it positive or negative (except for the Subwoofer in Fig.6 since it is the farthest speaker), you will find the best time alignment and correct acoustic scene.  
It is advisable to listen to different types of music (percussion, melodic, etc.) for a comprehensive evaluation of different musical instruments (space stability).
6. Once the time alignment procedure is complete, you can work on the output equalizer (see 8.12), to optimize the system response in accordance with level alignment of different frequencies.

**Remark:** measurements for the above operations can also be taken by using a spectrum analyzer with an appropriate microphone. The results must be assessed with final refining listening tests.

**WARNING:** If, once you have set the distances for the "driver" listening point, you click on the "passenger" listening point, the **bit Ten** won't re-calculate the delays for the new reference point because the buttons available in the SELECT A CHANNEL diagram are merely descriptive. Their only purpose is to remind you that you have set the delays for that listening point!

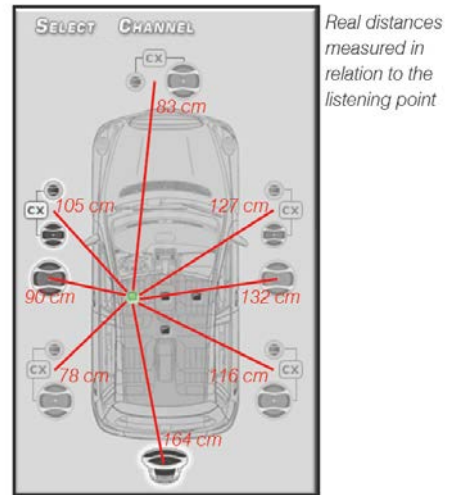

Fig. 4

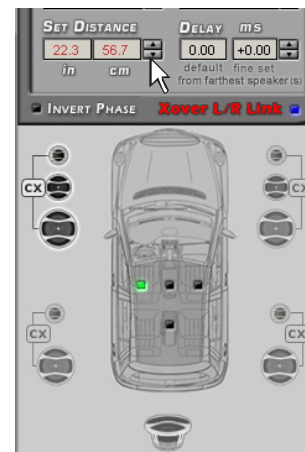

Fig. 5

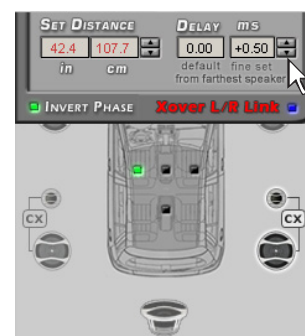

Fig. 6

8.12 GRAPHIC EQUALIZER 9

The bit Ten software features a 31-band, ± 12 dB graphic equalizer for each system channel. In compliance with ISO requirements, frequencies are equally spaced at 1/3 Oct. from 20 to 20 kHz. The equalizer works according to the functioning mode chosen. So we have:

- one equalizer for the **Front**.
- one equalizer for the **Rear**.
- one equalizer for the **Subwoofer**.

**Eg.:** if examining the system described so far there would be:

- one equalizer for the **Front Mid-Tweeter**.
- one equalizer for the **Front Woofer**.
- one equalizer for the **Subwoofer**.

In order to set an equalization curve, you just have to select the channel you want to equalize from the **Channel Map** menu and left-click the slider you want to set with the mouse.

To shape an equalization curve, you just have to right-click the first slider on the left of the equalizer and move the equalizer sliders towards the right, shaping the curve as you like (see Fig. 1).

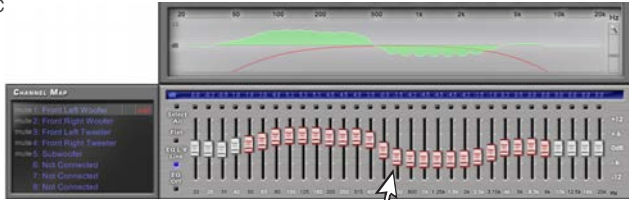
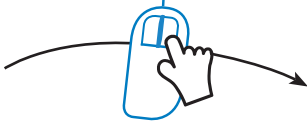

Fig.1



The graphic equalizer features five specific functions to ease adjustments (see Fig. 2).

1. **Select ALL** once an equalization curve has been set, this provides the ability to move all the cursors at the same time.
2. **Flat**, brings all the cursors back to the 0 dB position;
3. **EQ L/R Link** when active, applies the equalization curve to both the right and the left channel simultaneously.
4. **EQ Off** when active, provides the ability to disable the equalizer to check its effect without losing its settings.
5. One **Select** button for each equalizable band, providing the ability to move all the selected cursors all together.

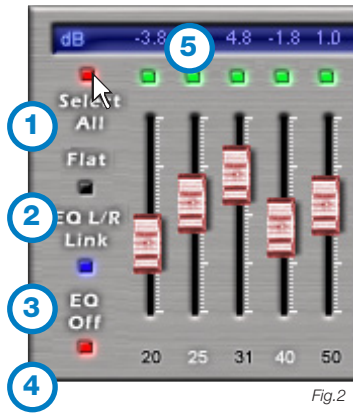

Fig.2

**Remark:** in order to display more clearly the set equalization curve, the vertical axis (dB) can be increased or decreased by moving up/down the cursor on the right of the equalization curve graph (Fig. 3). By default the graph visualization range is set at ± 12dB

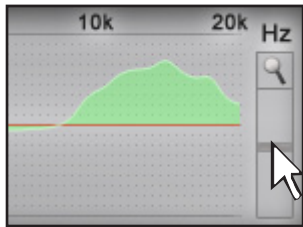
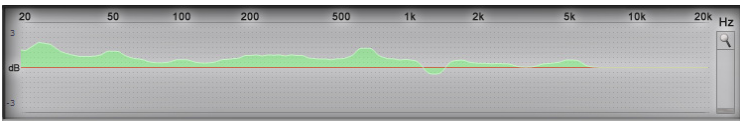
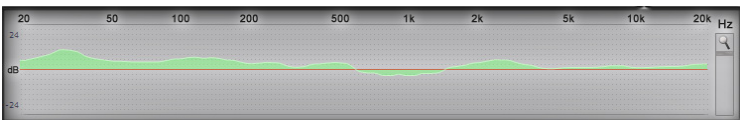

Fig.3



Example of visualization with magnifier function ± 3dB



Example of visualization with magnifier function ± 24dB

**8.13 OUTPUT LEVEL** 10

This section details the output levels of the **bit Ten** channels as displayed by the software. Please note the description of each of the points marked with numbers in the image below.

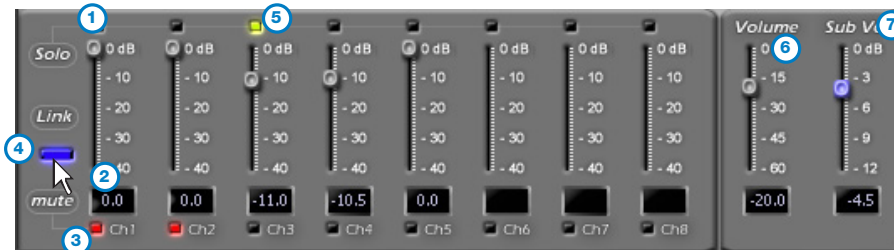

- ① By acting on one of the sliders belonging to the output channels, you can adjust the output level (-40÷0 dB) for each channel. The sliders activate according to the output SETUP.
- ② This area shows the output level of each single channel (-40÷0 dB), compared to its slider position.

**WARNING:** The CH6, CH7, CH8 output channels are only available in the digital I/O of the **bit Ten D**.



- ③ If you click the **Mute** button, you can mute the corresponding output channels. If you click the **Mute** button again, output will resume
- ④ If you click the **Link** button, you can simultaneously adjust all the **bit Ten** output levels. If you click the **Link** button again, the function will be disabled.
- ⑤ By clicking on the **“Solo”** button the output channels, with the exception of the activated one, will be muted. By manually clicking on the **“Solo”** button this function will be disabled.
- ⑥ By using the **Volume** slider, you can adjust the general system volume (-60÷0 dB).
- ⑦ By using the **Sub Volume** slider, you can adjust the Subwoofer output level (-12÷0 dB), if the system features a Subwoofer.

**Remark:** if installation includes a mono Subwoofer, the sensitivity of its dedicated amplifier needs to be increased by +3 dB compared to the rest of the amplifiers (see the “Amplifiers Sensivity” chart). This empirical method takes many factors into account and provides a better adjustment of the **“Sub Level”**.

**Amplifiers Sensivity (Volts)**

<b>Front / Rear</b>	1.0	2.0	3.0	4.0
<b>Sub (+3 dB)</b>	0.7	1.4	2.1	2.8

**WARNING:** the output level adjustment as detailed in ② affects the system signal / noise ratio (**whistle / background hiss**).



We recommend that you always set the **bit Ten** output level high and the amplifiers sensitivity low, so that the amplifiers will be less affected by noises / background hisses.

Unfortunately, a too high output level introduces clipping on the processor outputs, especially if equalizations with high gain are applied. We therefore recommend that you proceed as follows:

- a- Set the amplifiers sensitivity level at the minimum (3-4 V RMS). If you have not already done it ([see 8.1.21](#)).
- b- Balance the emission level of the system channels by moving the cursors ① paying attention to maintain a mid level centered at around -20 dB. Turn the output volume to an acceptable listening volume level.

- c - Set the desired output equalizations ([see 8.12](#)).
- d - Insert a CD with a highly dynamic track.
- e - Select the **Link** function (4), move the cursor and increase the output channels level until possible clipping occurs; in this case move the cursor back at least 2-3 dB (check the value on one of the displays (2)).
- f - Increase the **Volume** (6) to the maximum undistorted level taking it close to "0" dB.
- g - In case the signal is highly distorted with the Volume at "0" dB, you will have to decrease the output levels (2). If, on the contrary, no distortion occurs, you will have to increase the amplifiers sensitivity until the first distortion symptoms show: by doing this, you will make the most of the available undistorted signal.

**Ramark:** This procedure leads you to set the system at "zero dB undistorted". This is not always the best solution, since a loss in dynamic range may occur, if you listen to a track that has been registered at a lower level or with lower dynamic range than the track used for the setup. So a good compromise needs to be found, depending on the listener.

## 8.14 MEMORY 11

The bit Ten uses memory **A** by default for the system's configuration; however, it also offers the possibility to store and recall two memories (**A, B**). By pressing the **MEMORY** button on the main menu, different functions are available for the featured presets.

The following features are available:

- **Load All Presets:** loads both memories (A/B) from a file previously saved (.prs format).
- **Save All Presets:** - saves both memories (A/B) in a file that can be recalled (.prs format).
- **Load Current Preset:** loads a memory previously saved (.pro format) by overwriting the memory you are working on.
- **Save Current Preset:** saves the memory you are working on in a file that can be recalled (.pro format).
- **Copy Preset From:** copies the content of one memory into the current memory.
- **Current Preset Default:** restores the crossover and equalization default values that would be proposed at the end of the setup procedure.

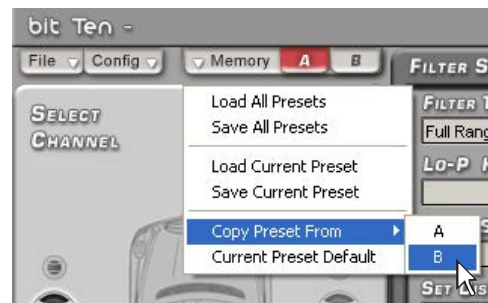

The following data are stored in each memory:

- the filter settings for each channel;
- the time delay settings for each channel;
- the equalization settings for each channel;
- the output levels of each channel;
- listening point markers.

We recommend that you copy the parameters entered in the memory you are using into the memory that is not being used. These memories can be recalled through the DRC. If some memories are not stored, they will contain the default settings.

## 9. TROUBLESHOOTING

### 9.1 SYNCHRONIZATION WITH A PC

#### 1. bit Ten functioning problems

- If, while tuning the system with a laptop PC, the **bit Ten** shows some problems functioning, try to disconnect the laptop PC power supply cable. This way, with the laptop PC working on battery power, you avoid a possible voltage difference in USB ground between car ground (**bit Ten**) and earth (PC).

#### 2. The bit Ten does not connect to the PC software

- If, while tuning the system with a laptop PC, the **bit Ten** is switched off and then on again, the connection is lost and the software can not "finalize" the selected setup. If you don't want to lose the modifications and setup previously selected, proceed as per the following steps:
  - a- save the setup as a file on the PC using the function **FILE / SAVE SETUP**;
  - b- exit the software;
  - c- turn on the **bit Ten**;
  - d- launch the software again;
  - e- load the setup file again using the function **FILE / LOAD SETUP**.

#### 3. The bit Ten does not respond

- If, while tuning the system with a laptop PC, the **bit Ten** does not respond, proceed as per the following steps:
- a- turn the **bit Ten** off with the DRC knob, disconnect the Remote IN, or disconnect the power supply cable for a few seconds;
  - b- save the setup as a file on the PC using the function **FILE / SAVE SETUP**;
  - c- exit the software;
  - d- turn on the **bit Ten**;
  - e- launch the software again;
  - f- load the setup file again using the function **FILE / LOAD SETUP**.

#### 4. Settings not stored

In order to successfully complete the **bit Ten** setup and not lose the work done, remember to store the selected settings. Select **File** from the main software menu via the PC and then choose **Finalize to bit Ten**.

### 9.2 BACKGROUND NOISE

#### Loud whistle / background hiss.

In case a loud whistle / background hiss can be heard, it may be necessary to repeat the input sensitivity setup and / or to rectify the output levels adjustment. For more information, [see sections 8.1.2 - 8.1.13](#) in this manual.

### 9.3 FIRMWARE UPGRADE

In case product UPGRADES are available online, proceed as follows:

- Save the previous setup (in case you want to open it in OFFLINE mode);
- Unplug the **bit Ten** RCA plugs to the amplifiers.
- Restart the **bit Ten** PC software and select **TARGET** mode.

1. Select **FILE** from the PC main software menu and then choose **Check for Updates**.



2. Select **Check for Updates**; the internet browser installed in your PC will open and automatically search for the URL:

<http://update.audison.eu/>

**WARNING:** You have to manually download the files from the above website. The method to access the software may differ from the one described here. Please, always follow the instructions you find on the website.

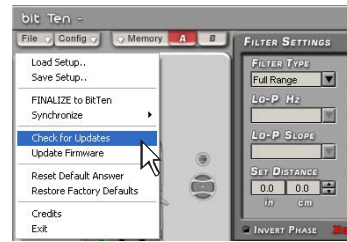

3. Once the website page has opened, click on the LINK (red arrow).

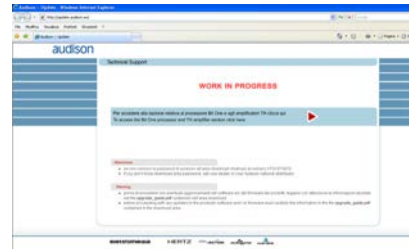

4. To access the Download Area where the updated versions of Installation Guide, Advanced Manual, Software and Firmware are available for download, you have to enter the word **bitten** in both the LOGIN and PASSWORD box.

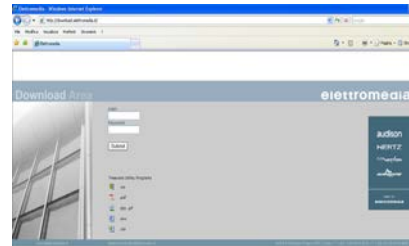

5. Look for the most updated file showing the word Firmware followed by four numbers and click its icon to start the download. When requested, save the file to your PC.

6. Select **Update Firmware**; the software will ask you to select the file that you just downloaded from the Download Area or that you previously saved in your PC.

**WARNING:** To ensure the Firmware is updated correctly, disconnect, if any, the terminals for the hands-free kit in use from the **bit Ten** PHONE inputs.



The **bit Ten** firmware update procedure requires particular attention. So, it must be performed under the best possible conditions: if the firmware update is launched but prematurely interrupted (for example, because the PC locks up, or a supply voltage drop occurs to the **bit Ten**, or the USB accidentally disconnects during the update), you may have to reprogram the **bit Ten** in **Rescue Mode** (see 9.4). In extreme cases, you may have to contact our Customer Service for further support as **bit Ten** reprogramming may be necessary.



7. Before starting the **bit Ten** update, the software will present the following warnings:
- do not disconnect the **bit Ten** from the PC;
  - do not disconnect the **bit Ten** from power supply;
  - temporarily disable the PC stand-by and energy saving features;
  - temporarily disable the PC screen saver;
  - close all running applications;
  - temporarily disable anti-virus and anti-spyware systems.

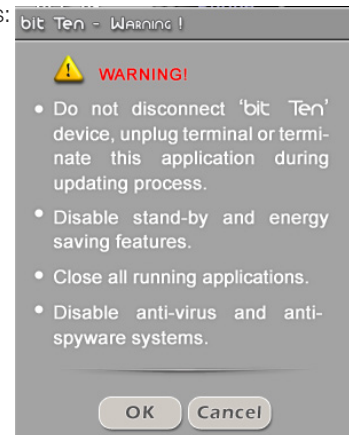

8. Once you have clicked **OK**, the Firmware update starts. The updating process will last from 30 seconds to 1 minute with the green progress bar showing correct advancement.

**WARNING:** During the updating process the progress bar could stop for few seconds. Do not interrupt the process in any way.



9. Once the update has been successfully completed, the window on the right will appear. To use the **bit Ten** again, you have to exit the PC software and the **bit Ten** will turn off.



10. Start the **bit Ten** again and launch the PC software in **TARGET** mode. If the **bit Ten** firmware update has completed correctly, the dialog box will show the following indications:
- new **bit Ten** firmware version.

11. Repeat the **bit Ten** calibration procedure ([see 7.1 - 8.1](#)).

### 9.4 RESCUE MODE

If, when launching the **bit Ten** PC software the “**bit Ten Warning**” window appears, you can choose between the following two ways to proceed:

- A** - Use a previous version of the PC software.  
**E.g.** if you are using PC software v.1.0, open v.0.9;
  
- B** - Update the **bit Ten** firmware. In this case you will have to proceed as follows:
  - Save the previous setup (in case you want to open it in **OFFLINE** mode);
  - Unplug the **bit Ten** from the amplifiers;
  - Turn the **bit Ten** off, disconnect the power supply;
  - Set the **UPGRADE MODE** to **ON** ([see 4.5.6](#));
  - Reconnect the power supply and turn the **bit Ten** on;
  - Restart the **bit Ten PC** software and select **RESCUE MODE**.

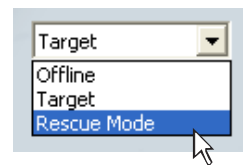

- The screenshot on the right shows the Boot Loader version currently installed on the processor, which allows you to access the menu for the update.



- Proceed as detailed in 9.3.1

## 10. DRC - DIGITAL REMOTE CONTROL

The DRC is the **bit Ten** remote control system. It is a microprocessor digital system that also controls and monitors the amplifiers equipped with the ACLink bus control, if present.

When it is turned on the first time, the display will show the firmware version installed in the DRC.

When the **bit Ten** is setup through the PC, the DRC can stay connected but its display will show the message "PC control - DRC is disabled".

### The DRC features are:

- **bit Ten** power on / off;
- Main volume control;
- Subwoofer volume control;
- Front / Rear fader control;
- Set sources selection;
- Memory selection.

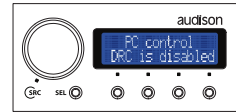

DRC CONTROL FROM PC

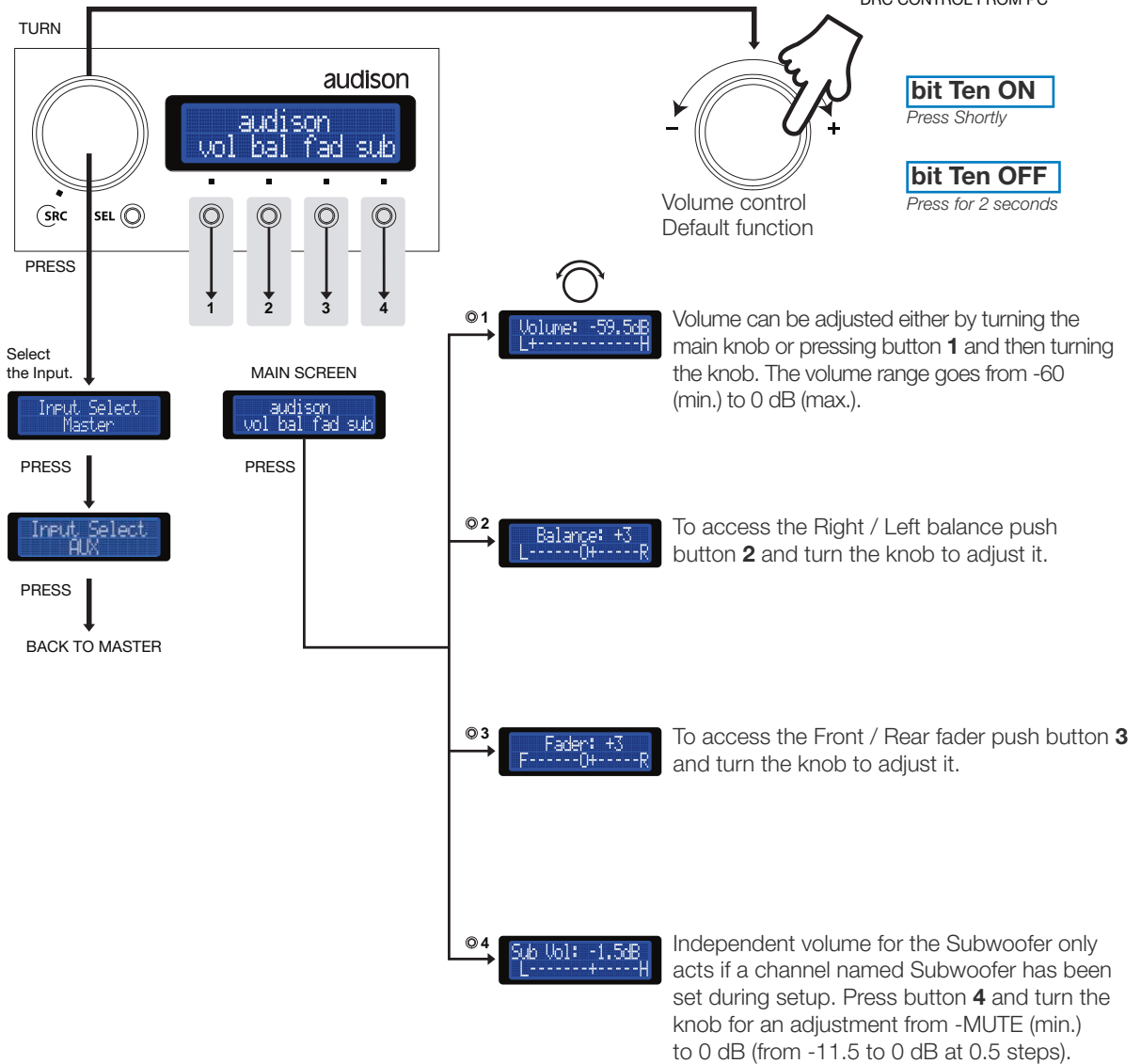

### 10.1 PHONE CALL

The **PHONE** input can not be selected as a normal source because it activates exclusively when an external hands-free phone kit sends the **MUTE** impulse when receiving a phone call. The DRC display will show the message **bit Ten - PHONE CALL**. The **bit Ten** will set the source selected in that moment to mute, reproducing the signal coming from the **PHONE** input. During the phone call, the volume can be adjusted through the DRC knob.



### 10.2 SEL BUTTON - FUNCTIONS

By pressing the SEL button you can access:

- **DSP Memory:** A/B memories (saved through software) can be recalled and loaded into the processor (**bit Ten**).

- **DSP Settings:** lets you go back to the head unit volume level used when the **bit Ten** was calibrated. Select YES, insert the CD Setup Track 1 in your CD player and adjust the head unit volume so that the display will show the message GOOD.

- **Brightness:** to adapt the DRC to the light conditions inside the car, you can adjust the display and red switch brightness.

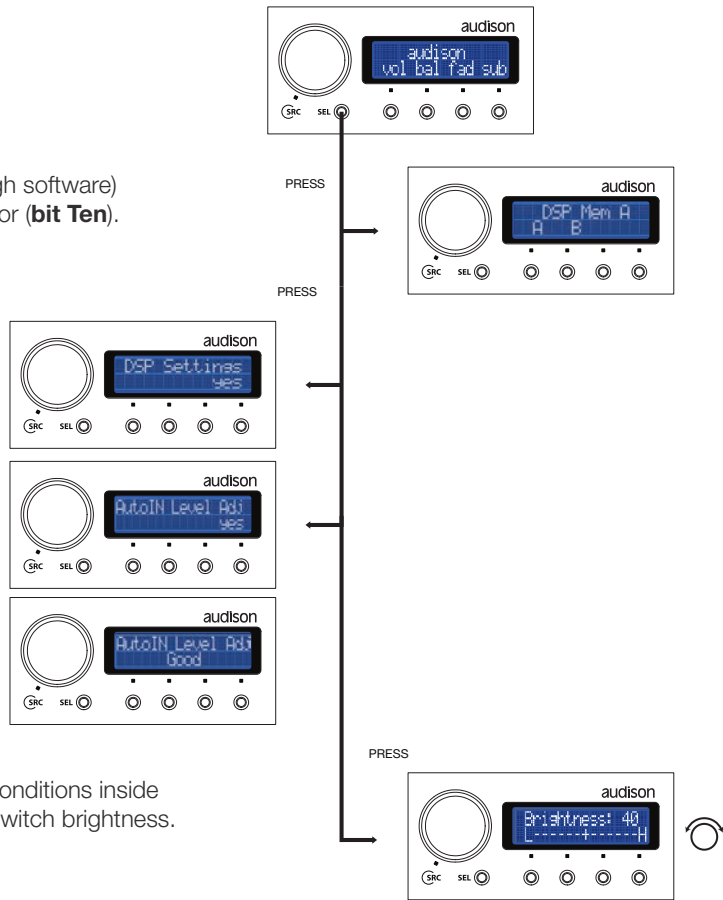

### 10.3 BYPASSING THE DRC

You can bypass the DRC from the system to adjust the listening volume through the head unit and the steering wheel if featured.

The following conditions are required to bypass the DRC:

- you do not use the AUX input.
- you do not use the memories.

### 10.4 DRC FIRMWARE UPGRADE

If, when launching the bit Ten PC software, the “bit Ten Warning” window pops up, it means that the DRC Firmware needs to be updated.

#### Important Remark

1. The steps of this upgrade must be performed strictly FOLLOWING THE SEQUENCE here, exactly as per the chronological order indicated in this document.
2. The firmware upgrade should be performed with care, following the warnings listed in the DRC firmware upgrade section of this document, to avoid damaging the product.
3. In order for the DRC to be upgraded, it must be connected to a **bit Ten**.

#### Preliminary steps:

1. Create a new folder (named for example: DRC upgrade) on the PC Desktop, or wherever you prefer.
2. Download from <http://update.audison.eu> the zipped folder called, for example, “DRC\_upgrade\_firmware V1 90.zip” and save it in the folder you have just created.
3. Open the zipped folder “DRC\_upgrade\_firmware\_V1\_90.zip” using suitable software (for example WinZip or “Compressed folders” Windows utility if available in your PC), and save the file you find inside it (“DRC\_upgrade\_firmware\_V1.90.exe”).

**Remark:** The firmware update procedure requires particular attention. So, it must be performed under the best possible conditions: if the firmware upgrade is launched but prematurely interrupted (for example because the PC locks up, or a supply voltage drop occurs to the **bit Ten**, or the USB accidentally disconnects during the firmware upgrade), you might need to contact our Customer Service for further support as DRC reprogramming may be necessary.

1. Connect the PC to the audio system where the DRC is installed (**bit Ten**) using a USB cable.
2. Supply power and turn on the **bit Ten**, so that the DRC is on.
3. Launch the program “DRC\_upgrade\_V1\_90.exe”.
4. Select bit Ten and then click **OK**.
  - disable anti-virus software.
  - Click **YES**.
5. The PC is synchronized with the DRC. Then click on:
  - **DRC Upgrade Vxxx** to update the device.
  - **Quit**: to exit.
6. A warning pop-up dialog box will appear, indicating that you have to:
  - close all running programs;
  - disable any screen saver;
  - disable energy saving modes;
  - disable any anti-virus software.
 Click **YES**.
7. Wait until the upgrade procedure is complete.
8. A pop-up dialog box showing the message Upgrade completed will appear. Click OK.
9. Click **Quit** to close the DRC Upgrade Software.

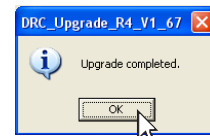
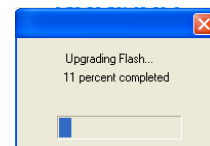
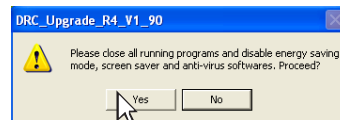

# 11. bit Ten ACCESSORIES

## 11.1 DRC CABLE EXTENSION KIT

This kit is composed of a cable and adapter allowing 2 m / 78.74" additional extension of the cable supplied with the DRC.

This extension is necessary in installations on particularly long vehicles such as large SUVs.  
The total length of the supplied cable with the extension is equal to 6.5 m / 225.90".



### CONNECTION PATTERN:

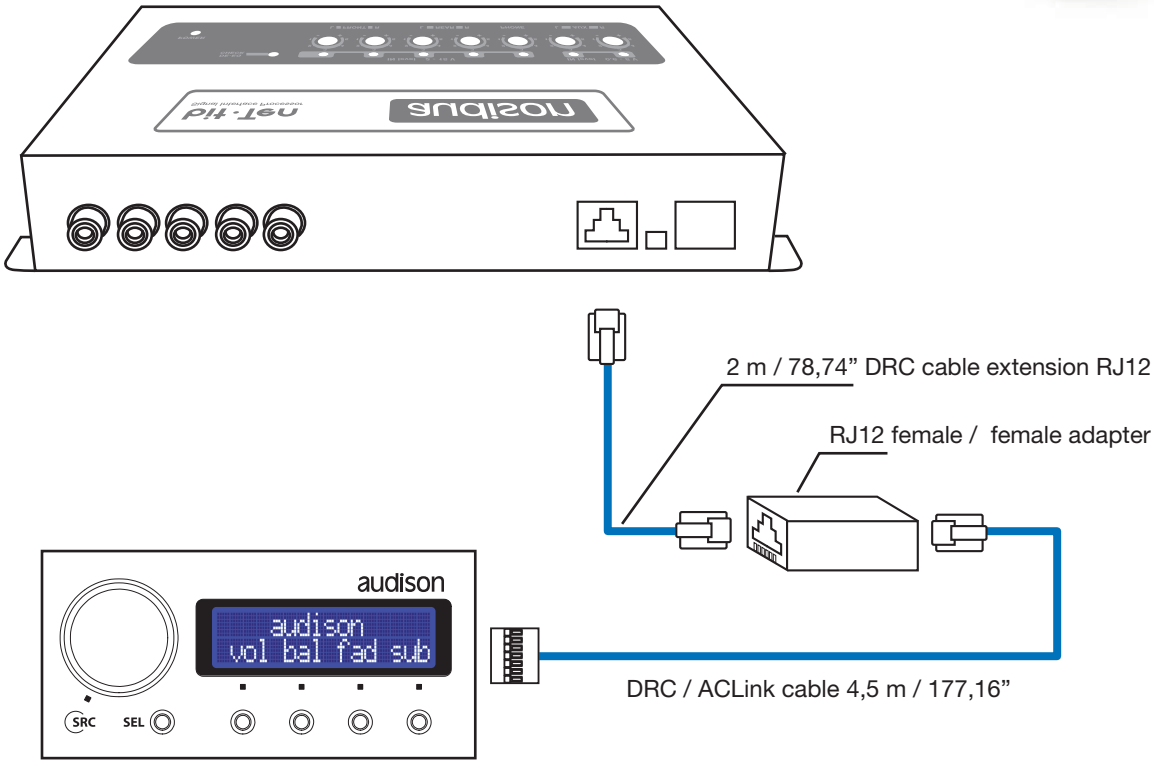

## 12. TECHNICAL SPECIFICATIONS

### POWER SUPPLY

Voltage	11 ÷ 15 VDC
Idling current	0.4 A
Switched off without DRC	2.5 mA
Switched off with DRC	4 mA
Remote IN voltage	7 ÷ 15 VDC (1.3 mA)
Remote OUT voltage	12 VDC (130 mA)

### SIGNAL STAGE

Distortion - THD @ 1 kHz, 1V RMS Output	0.005 %
Bandwith @ -3 dB	10 ÷ 22k Hz
S/N Ratio @ A weighted	
Master Input	95 dBA
AUX Input	96 dBA
Channel Separation @ 1 kHz	85 dB
Input sensitivity (Speaker In)	2 ÷ 15 V RMS
Input sensitivity (AUX In)	0.6 ÷ 5 V RMS
Input sensitivity (PHONE)	2 ÷ 15 V RMS
Input impedance (Speaker In)	2.2 kΩ
Input impedance (AUX)	15 kΩ
Input impedance (PHONE)	2.2 kΩ
Max Output Level (RMS) @ 0.1% THD	4 V RMS

### INPUT STAGE

High Level (Speaker)	FL - FR - RL - RR, Phone IN
Low Level (Pre)	AUX IN

### OUTPUT STAGE

Low Level Pre (default)	FRONT L/R, REAR L/R, SUB
-------------------------	--------------------------

### CONNECTION

From / To Personal Computer	1 x USB / B (1.1/2.0)
-----------------------------	-----------------------

### CROSSOVER N.5 (one each output channel)

Filter Type	Full / High Pass / Low Pass / Band Pass
Filter mode and slope	Linkwitz @ 12 / 24 dB Butterworth @ 6 / 12 / 18 / 24 dB
Crossover frequency	68 steps @ 20 ÷ 20k Hz
Phase control	0° ÷ 180°

### EQUALIZER

On Hi-Levels input (Speaker In)	Automatic De-Equalization
On Outputs	N.5 Graphic: ±12 dB @ 31 Band ISO 1/3 Oct. 20 ÷ 20k Hz

### TIME ALIGNMENT

Distance	0 ÷ 510 cm / 0 ÷ 200.8 inch
Delay	0 ÷ 15 ms
Step	0.08 ms; 2.8 cm / 1.1 inch
Fine set	0.02 ms; 0.7 cm / 0.27 inch

### SIZE

W (Width) x H (Height) x D (Depth) mm/inch	191 x 34 x 131 / 7.51" x 1.33" x 4.76"
Weight kg/lb	0.6 / 1.322





ideato,  
progettato,  
costruito  
in Italia



Tutte le specifiche riportate sono soggette a cambiamento senza preavviso

# audison

PART OF **ELETTROMEDIA** - 62018 Potenza Picena (MC) Italy - T +39 0733 870 870 - F +39 0733 870 880 - [www.elettromedia.it](http://www.elettromedia.it)