

audison.eu



# THESIS

PRODUCT INFORMATION  
2020



audison



## THESIS: BEYOND THE ABSOLUTE

**The Thesis project, a perfect synergy between technique and emotion, is dedicated to the most demanding audiophiles.**

**Distinguished by the absolute lack of compromise** and the very high technological content, it reserves parameters of excellence and absolute quality to each component.

**HV venti**, defined by experts all over the world, **"The Amplifier"**, represents a **universal reference**.

A project of high engineering focused on **extraordinary musicality, transparency and naturalness**.

TH amplifiers are born from the **know-how obtained with HV venti** with the integration of **digital technology**.

**Transparency, a direct inheritance of the HV venti**, is the principle that inspired the creation of **Thesis speakers**, born with the ambitious goal of giving voice to the pure musical message of **Thesis electronics**.



All specifications subject to change without notice\_20.A



**Elettromedia**  
62018 Potenza Picena (MC) Italy  
T +39 0733 870 870 - F +39 0733 870 880  
elettromedia.com

audison



THEESIS: BEYOND THE ABSOLUTE	2	TH K3 II A ORCHESTRA	35
The genesis of HV venti	4	EID TECHNOLOGY	37
HV venti unique design	7	Tech. Sheet HV venti	38
TH AMPLIFIERS	9	Tech. Sheet TH Quattro	39
TH Amplifiers technology	12	Tech. Sheet TH due	42
THEESIS SPEAKERS	15	Tech. Sheet TH uno	44
TH 1.5 II Violino	17	Tech. Sheet TH 1.5 II Violino	46
TH 1.5 II violino Tuning System	22	Tech. Sheet TH 3.0 II Voce	48
TH 3.0 II Voce	23	Tech. Sheet TH 6.5 II Sax	49
TH 6.5 II Sax	24	Tech. Sheet TH K2 II A CORO	51
TH K2 II CORO A SYSTEM	32	Tech. Sheet TH K2 II P CORO	54
TH K2 II CORO PASSIVE	34	Tech. Sheet TH K3 II A ORCHESTRA	55



All specifications subject to change without notice\_20.A



**Elettromedia**  
 62018 Potenza Picena (MC) Italy  
 T +39 0733 870 870 - F +39 0733 870 880  
 elettromedia.com





## THE GENESIS OF HV VENTI



Audison has a long history in the pursuit of perfection in audio performance.

**As early as 1991, HR 100** stood out as a benchmark, bringing the Audison brand into the Olympus of Hi-End manufacturers. Produced up to the year 2003 it has never been forgotten by fans all over the world.

HR 100 was designed to obtain the highest sound quality without compromises. Its maximum power output was its only limitation, as technology of the time did not allow this reference sound quality with massive power. Four years later the THESIS brand was created. Using the latest technology, Audison once again rewrote history on amplifier performance. **In 1995 and in 1996 respectively, HV sedici and HV trenta amplifiers came to light.**

THESIS and HR 100 have a strongly distinctive sound, which could not be improved in its uniqueness, but one way to try was: to merge the two projects into a single amplifier, long-held in the dreams of Audison designers. **After two years of research, with HV venti, the dream became true.**

**Like its predecessors, HV venti is an absolute reference product for the years to come, indelibly marking the history of Hi-End mobile electronics.**





# HV VENTI, THE AMPLIFIER



Hi-Res  
AUDIO

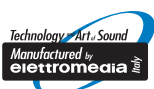

**Elettromedia**  
62018 Potenza Picena (MC) Italy  
T +39 0733 870 870 - F +39 0733 870 880  
elettromedia.com

audison

THESIS

Hi-Res  
AUDIO

**Absolute lack of compromise** in achieving maximum performance, this is the mantra followed by the Audison R&D for the HV venti, a project with the following unique features.

Output power stage based on an **innovative topology similar to IGBT (Insulated Gate Bipolar Transistor) but employing discrete devices.**

**Total void of integrated operational circuitry** that, due to their constructive technology and the low voltage level can deteriorate the signal. Their elimination allowed the engineers to work at higher voltages and with a **Class biasing of the intermediate stages.**

**All signal commutations were treated using special relays:** too complex of a circuit would have led to longer tracks and parasitic inductances, causing signal deterioration and loss of musical information.

**The whole input circuit is balanced** up to the final stage "Front End", while the amplifier's configuration is **"Dual Mono"**.

In order to avoid electro-magnetic interferences, no high current is passed on the main board.

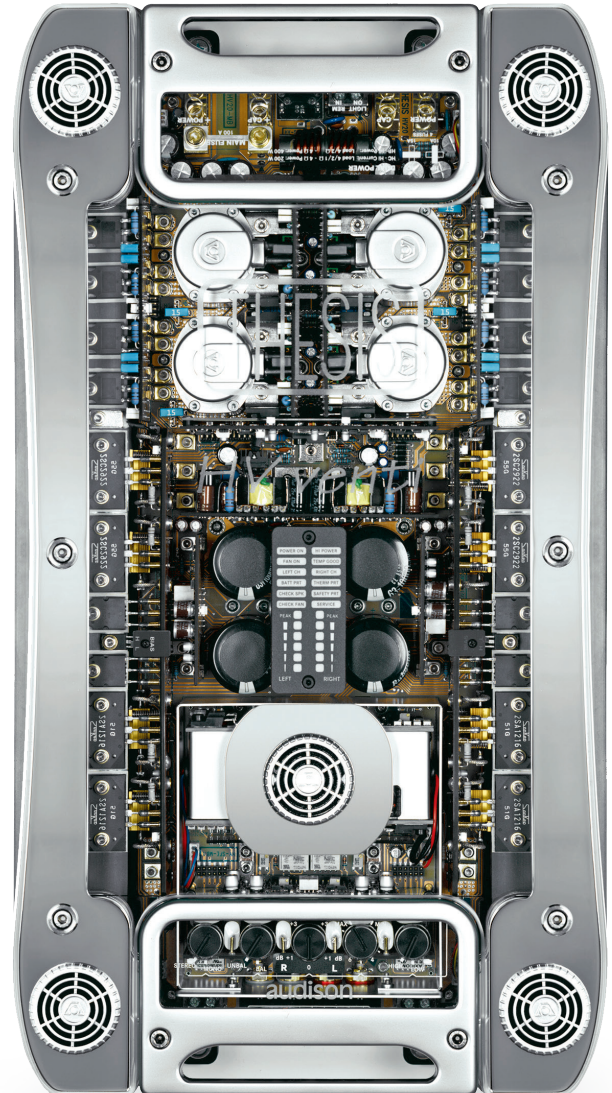

*"The Thesis HV venti sets new standards in the world of car audio amplifiers. Only an extremely experienced designer could have created such an exclusive product. The six-stage power supply, the two-mode amplifier (high current, high power), the completely hi-end, discrete devices and straight sound path will be well appreciated by the musical enthusiast. But it's only the result of a deep reconsidering of the meaning of the mobile amplifier concept. Every part of the Thesis HV venti was a rethink, and every single component was optimised using the most exclusive devices, solutions and materials. Every electronic, mechanical, thermal and aesthetical aspect was improved by going back to the beginning. The Thesis HV venti is the wonderful synthesis of an extraordinary engineering effort."*



## HV VENTI UNIQUE DESIGN

### OUTPUT POWER STAGE

The output power stage is based on an innovative topology **similar to IGBT (Insulated Gate Bipolar Transistor) but employing discrete devices.**

The circuit is made from a complementary pair of Hitachi DMOS drivers, usually used as output stage devices (such as in HR100), which drive two pairs of SANKEN power BJT transistors providing each with 30 A peak current capability and 200 W dissipation.

This solution allowed **the use of only two pairs of output devices**, thus permitting bias currents which necessarily have to be shared according to the number of output devices in parallel to be reduced; therefore, increasing the bias current value on every output device is possible, keeping the total current absorbed by the amplifier stable when in idling status. All this leads to the **increase of the output stage to A class value.**

The percentage of A Class and consequently the idling current can be adjusted via the BIAS current diverter. As a result of the configuration of the HV venti in **Hi Power or Hi Current mode**, there will be a variation of the A Class percentage and therefore of the idling current also.

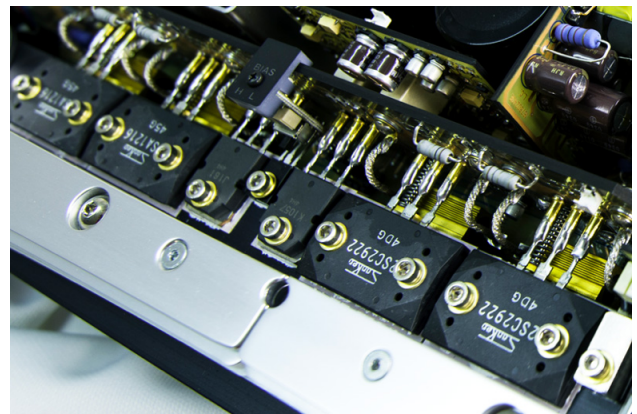

### CROSSOVER

**To guarantee maximum sound quality, the crossover was made on a separate module supplied with the product.**

Available adjustments are Hi Pass/Lo Pass 12 dB and Lo Pass 24 dB mono. Four cut-off frequencies are selectable for the filter (45; 55; 65; 80 Hz). Although this solution is limiting compared to a continuously adjustable cut-off, filter linearity is drastically improved and long signal paths are avoided.

### PREAMPLIFIER AND DRIVER

It is made of two groups, Front End pre-amplifier and control unit. **The whole stage is balanced up to the driver outputs.** The power supply voltage is 90 V and is specific for this stage and dedicated to the two separate channels.

The separate 150 V power supply is thermally stabilized and A Class biasing. Input is balanced with the **first stage, complementary JFET differential and the second stage, complementary BJT differential.** **The voltage amplifier is Cascode type** with a buffer to drive the output stage.

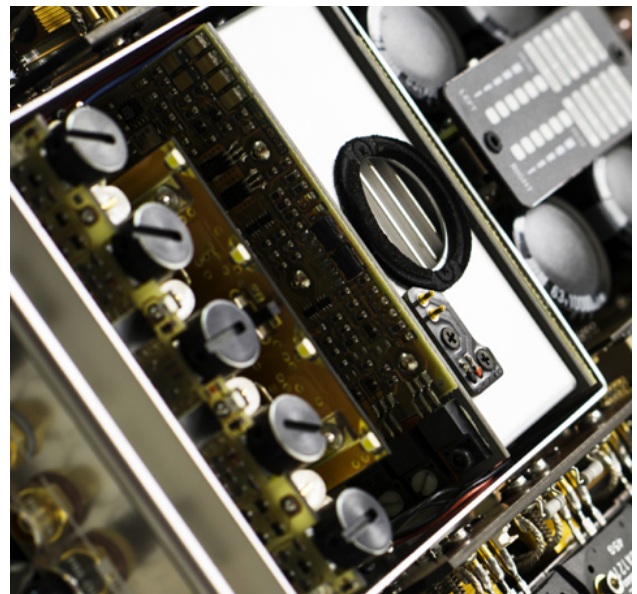

# THESIS

## POWER SUPPLIES

The product features **two Hi power supplies for each channel** providing power exclusively to the **Dual-Mono output stage**.

Each channel power supply pair works in Synchro-PMW mode: an independent circuit controls each of them.

However, they are synchronized with one another and are designed to supply one single power source, one supplies the positive and the other the negative power. This solution allows engineers to increase the impulsive current transient response necessary to the amplifier.

Furthermore, the two pairs of power supplies were synchronized to reduce radio frequency electro-magnetic interference.

The layout featuring four separate power supplies has allowed the use of a single powerful MOSFET for each power supply rail, thus avoiding the paralleled configuration that is perhaps the main cause of amplifiers failures.

**Each transformer and related filter inductor were enclosed in non-magnetic metallic shells and then filled with resin.**

This procedure further increases reliability for two reasons: first of all, coils are blocked and therefore made immune to vibrations; secondly, heat is homogeneously distributed, thus preventing any possible overheated areas.

The resin-filled groups were then mounted onto the aluminium thick bottom plate to allow heat to be dissipated through side heatsinks.

In order to avoid this kind of situation, you are often forced to use convoluted wiring which compel designers to accept compromises. Compromise is not accepted in the HV venti. Inside the HV venti **a six layer thick copper board was used to gather all output stage return currents**; the layout was created so that each current path comes close with the return current flowing backwards. This way the **electro-magnetic fields are out of phase** and nullify each other: this solution could be defined as a **"balanced power supply"**.





THESIS

# TH AMPLIFIERS



Hi-Res  
AUDIO





TH QUATTRO, TH DUE AND THE MONO TH UNO ARE THE ULTIMATE SYNTHESIS BETWEEN STATE-OF-THE-ART ANALOG AND DIGITAL TECHNOLOGY.



All models integrate a hi-end digital decoding section that makes them compatible with Audison Full DA HD technology, to better appreciate the higher resolution of Hi-Res audio files.

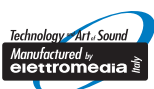
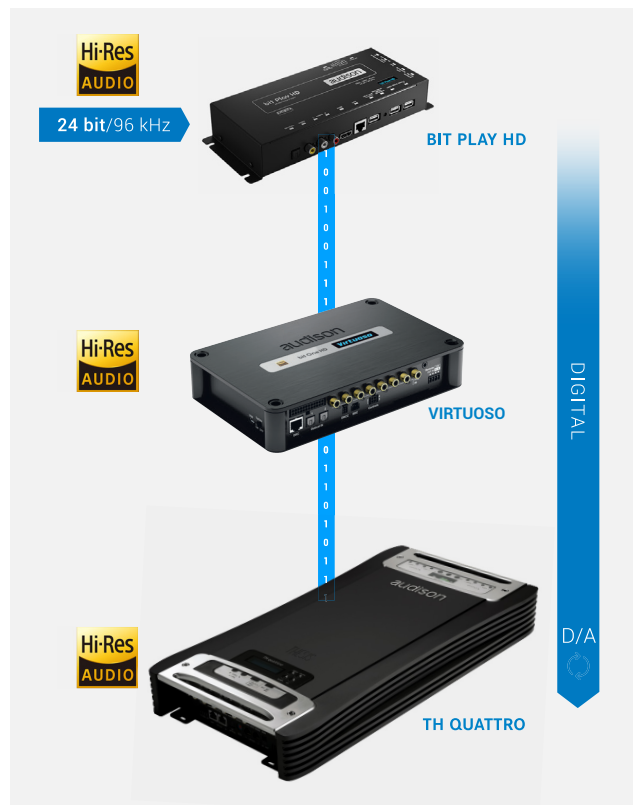

Elettromedia  
62018 Potenza Picena (MC) Italy  
T +39 0733 870 870 - F +39 0733 870 880  
elettromedia.com





The input panel of TH amps features AD Link connectors, dedicated to **receiving the digital signal from Audison bit sources or processors and relaunch it towards the amplifier chain in Full DA HD configuration**, through a shielded Cat.5 cable provided with an RJ45 connector.

The signal from very high quality sources can also be received **through the optical S/PDIF input** and relaunched digitally with the **AD Link system (Audison Digital Link) to other Thesis TH amplifiers**. Each amplifier will perform the **D/A conversion using a 24-bit 192 kHz PCM Hi-End converter**. The mix between the two worlds, which reside on two different boards to avoid any interference, has enabled the implementation of unprecedented solutions such as the **sensitivity control made possible with an encoder** that acts on the microprocessor to activate the Digitally-Controlled Analog Volume Control (D-CAVC), a resistive potentiometer with 256 steps of 0.5 dB, for a dynamic resolution of 120 dB.

In **Digital Input mode** and when connected with the **DRC control accessory**, the microprocessor converts the D-CAVC into a volume control that can replicate all other low frequency controls (Master Volume, Balance, Fader, Sub Volume).



All specifications subject to change without notice\_20.A



# TH AMPLIFIERS TECHNOLOGY

## DUAL POWER & BIAS CONTROL

A revolutionary **function called Dual Power** was introduced for the first time in the HV venti. Controlling the amplifier's output power configuration, this function allowed the predetermination of the amplifiers output power and of the grade of the outputs operational class.

There are four possible presets, which range from the Energy Saving function, allowing musical enjoyment for extended periods of time with the vehicles engine off, to Hi-Current and Hi-AB Class where the power is the priority even for difficult loads, **up to A Class, the best choice for musicality.**

## TOTALLY DIGITAL CONTROL

Thanks to the ACS contained within the TH amplifiers, and to a connection to a computer through the **AC Net (Audison Control Network)** software, the functions of all the Thesis amplifiers installed in the system are close at hand. The microprocessor stores the serial number, the hours of operation as well as the critical operational conditions; the software allows the user to customize the amplifier by giving it the owner's name and by saving the audio system amplifier settings. **Sensitivity adjustments, monitoring the working conditions and the possibility to adjust the amplifier power supply and operational class are just a few of the actions made available to the user with the AC Net software.** A USB connector enables the connection of the system to a computer, while the AC Link (**Audison Control Link**) allows the creation of a communication network. The software will take care of all the amplifiers functions within the whole chain (system), providing a simple and complete interface. **A revolutionary tuning method which, up to now, was impossible to achieve with traditional designs.**



## THE CROSSOVER

**High-end solution: the simplicity and power of the analog system found in the HV venti is thrust forward again in the TH, making use of the amplifiers versatility.**

A separate crossover module is provided with every TH amplifier. Through switches mounted on the module itself, it is possible to create a 12 dB/Oct Butterworth filter in a Hi-Pass, Lo-Pass or Band-Pass configuration. When TH uno or TH due or TH quattro is set up in a mono configuration, the slope of the filter can be set for 24 dB/octave operation.

Small modules, featuring high-precision resistor packs, installed into the main crossover module provide choice between 32 cut-off frequencies between 18Hz and 7,5kHz. Although this solution may seem limiting at first, this system contributes to a considerable improvement in the linearity of the filter and avoids long signal paths, vastly improving sound quality. For the most demanding of users, blank modules are supplied, allowing extreme personalization of the cut-off frequency.

## THE POWER SUPPLY STAGE

**The power supply is composed of five units.** A Flayback power supply is especially dedicated to the low-level signal section and operates a **Synchro-PWM mode along with four high efficiency power supplies**. The function of these power supplies is to provide energy exclusively to the final stage. The aforementioned final stage supplies, controlled by a specialized circuit, work in pairs to provide the positive and negative waveforms. This solution, an Audison tradition, increases the impulsive response speed required by the amplifier. The synchronized operation mode of the four separate supplies reduces RF electromagnetic disturbances and allows the use of a single high power/voltage MOSFET for each power supply section, avoiding the use of multiple paralleled devices. The supply partition and the implementation of two specific secondary windings for each transformer enable the Dual Power mode, settable by the user directly and managed entirely by the on-board microprocessor. The power supply dedicated to the low-level signals features two different branches, providing separate power for the analog and digital sections avoiding any possible conflict or interference.

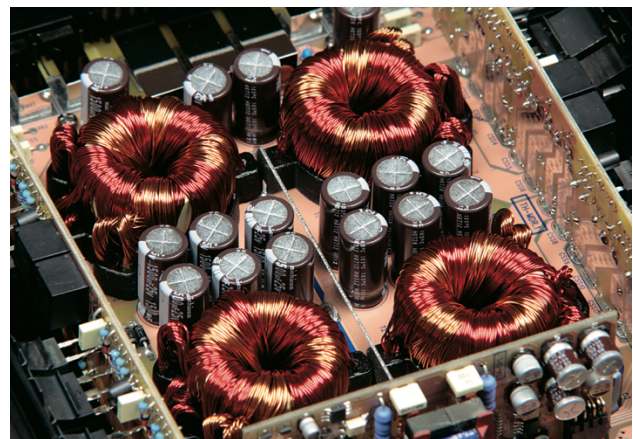
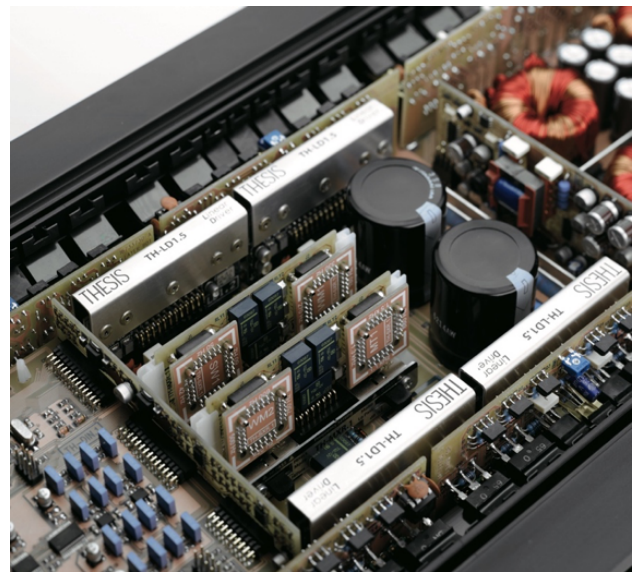



## POWER STAGE

As with the HV venti, the power stage is obtained through the use of groundbreaking circuitry, starting with the PCB layout. In order to control the strong supply currents of the final stages, the power outputs and the speaker ground return path, the power devices are installed on separate modules which nullify the rise of electromagnetic fields interfering with the signal path.

The pulsing heart of the amplifier features a complimentary differential output stage with current mirror, built using hand selected, matched pairs of transistors. The driver, or voltage amplifier, uses a Cascode type of architecture with triple complimentary inverted power stages. This imposing complexity of the layout, achieved through the use of absolute reference parameters, provides the **ability to use the amplifier in full A class bias, selectable** at the user's liking through the appropriate setting on the ASC.

## CHASSIS AND LAYOUT

The layout of the components and the design of the heatsink are reminiscent of the HV venti, and are designed in order to dissipate the heat generated by the amplifier, especially when used in A Class mode. **The chassis is extruded from solid aluminium and is then CNC (numerical control machines) machined to exacting standards.** A black anodized finish is employed to improve the heat exchange through the physical phenomenon of convection and radiation. The characteristic layout of the circuitry and power modules, assembled vertically and external to the mother board, offers the huge advantage of PCB circuits with extremely revolutionary dimensions to make the most of the signal path, aiding the amplifier power and sound quality.

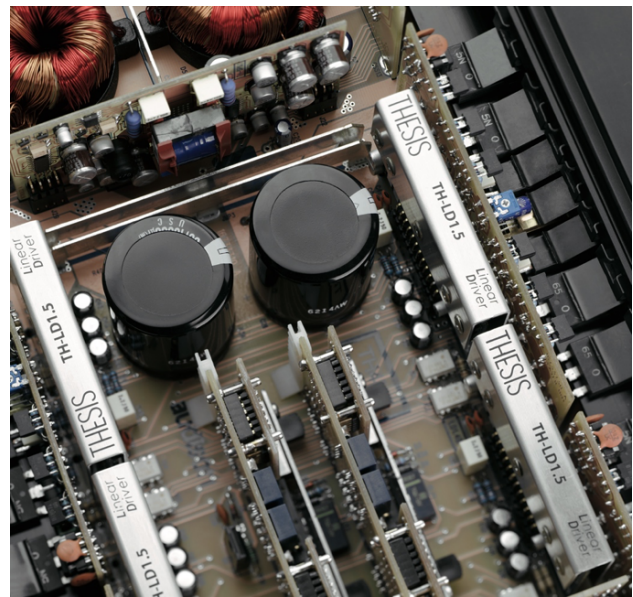

THESIS

# THESIS SPEAKERS





TH loudspeakers were created to transfer the precious musical message of the Thesis electronics with absolute fidelity, with the ambition to be absolutely transparent, leaving room only to the emotion evoked by the music.

The search for the best acoustic result was based upon overcoming the intrinsic limits of traditional loudspeakers.

Through a finite element simulation software (FEM) conceived by the Audison R&D team, a mathematical model was developed, which they used to create, with an intense prototyping activity, the ideal transducer.

Thesis speakers range consists of the TH 1.5 II Violino tweeter, the TH 3.0 II Voce mid-range and the TH 6.5 II Sax woofer which can be combined in the two-way passive system TH K2 II P Coro featuring the exclusive THX 2 II passive crossover or in the active configuration TH K2 II A CORO.

TH K3 II A Orchestra three-way active system is at the top of the Thesis speaker line, designed to set a new benchmark, where the synergy between the magnificent Thesis components expresses its maximum value.



All specifications subject to change without notice\_20.A



## TH 1.5 II VIOLINO

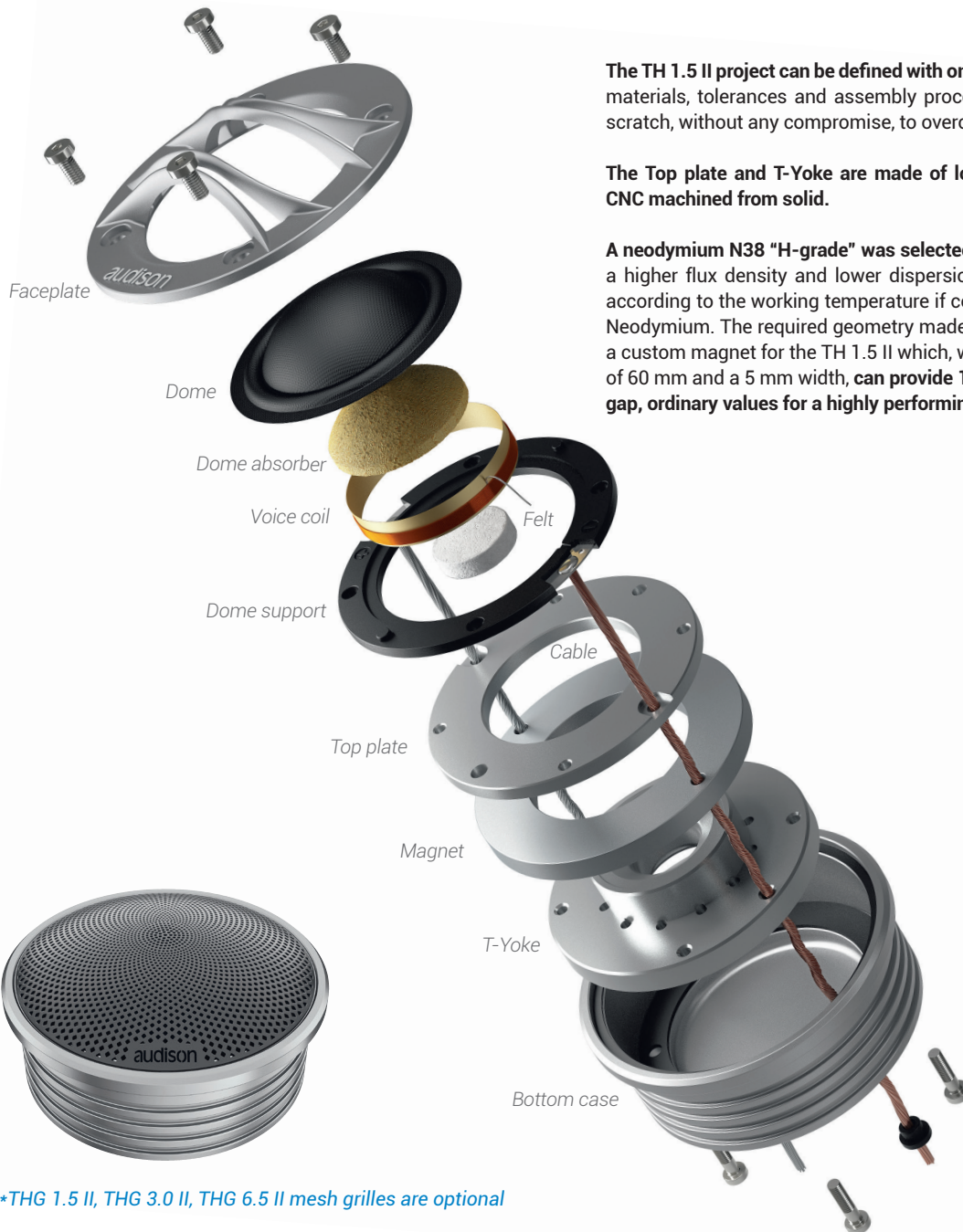

\*THG 1.5 II, THG 3.0 II, THG 6.5 II mesh grilles are optional

The TH 1.5 II project can be defined with one word: **uniqueness**. The materials, tolerances and assembly process were designed from scratch, without any compromise, to overcome the absolute.

The **Top plate and T-Yoke are made of low-carbon content steel CNC machined from solid.**

A **neodymium N38 "H-grade"** was selected for the motor, ensuring a higher flux density and lower dispersion of the characteristics according to the working temperature if compared to the standard Neodymium. The required geometry made it necessary to produce a custom magnet for the TH 1.5 II which, with an external diameter of 60 mm and a 5 mm width, **can provide 1.67 T\*m in the magnetic gap, ordinary values for a highly performing 6.5" woofer!**

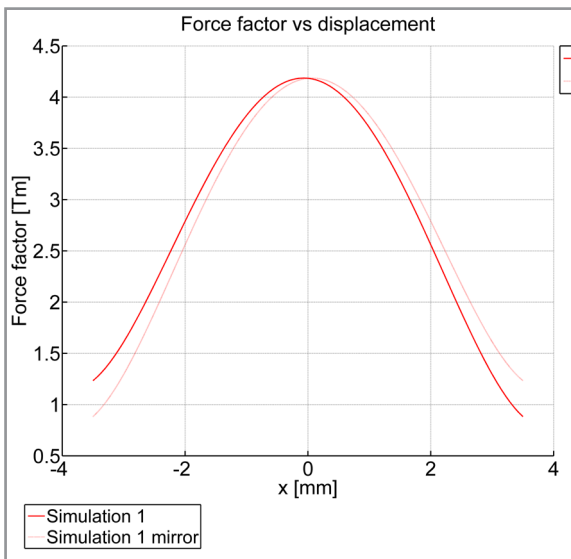

The magnetic circuit was sized with a flux saturation which can guarantee a low residual inductance at high frequencies, thus not requiring a magnetic short-circuit solution, such as copper rings, which reduces the flux into the magnetic gap.

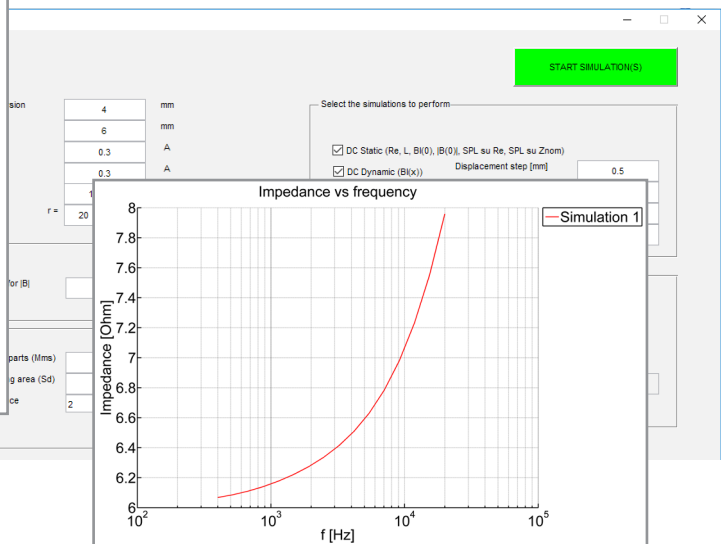

In-house developed FEM magnetic modeling suite

A magnet tailored to the Audison TH 1.5 II has also played a key role on its compactness allowing cables, in pure OFC 16 AWG section copper, to cross the whole magnetic/acoustic structure from the point of electrical contact with the coil terminals to the exit on the bottom case. In this way the cables are integrated without increasing the footprint.

Only a 34mm coil would allow the TH 1.5 II to express its best in the most complex musical passages thanks to the low dynamic compression. A single layer CCAW wire is wound on an aluminium former, a material selected for optimal damping. The choice of the single layer and a higher than average electrical resistance of the car audio tweeters (6.1 ohms) derives from the need to combine a low thermal resistance to a relatively low weight winding considering the size of the voice coil.

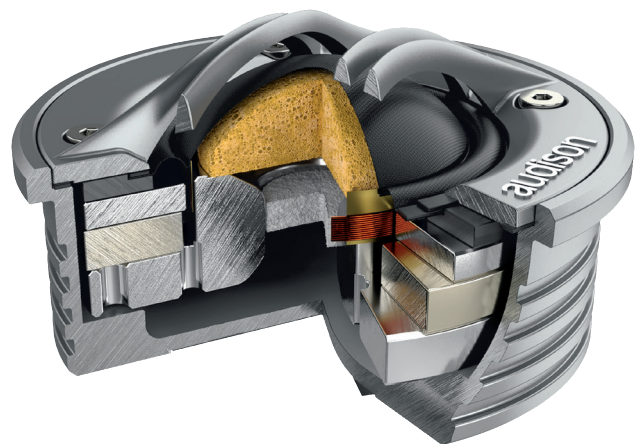

All specifications subject to change without notice\_20.A



Even more than in a cone speaker, the tweeter membrane is directly responsible for its sonic characteristics. Therefore, even before designing and testing the profile, the designers have selected the suitable varieties of silk membrane cataloguing them by the weaving material, density and damping treatments to characterize them with the use of the Klippel Scanning Vibrometer.

**Only after a thorough physical analysis of the various materials available and the creation of a refined model of vibro-acoustic simulation** was it possible to offer a set of 11 different dome profiles.

These profiles matrix-combined with the material variants in the finite elements simulation software, generated **33 different combinations for as many frequency and phase responses**, of which only three have seen the light and have then been tested and subjected to extensive listening assessments, which have made the current structure used in the TH 1.5 II successful.



TH 1.5 II Dome support assembly

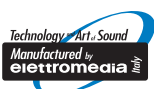
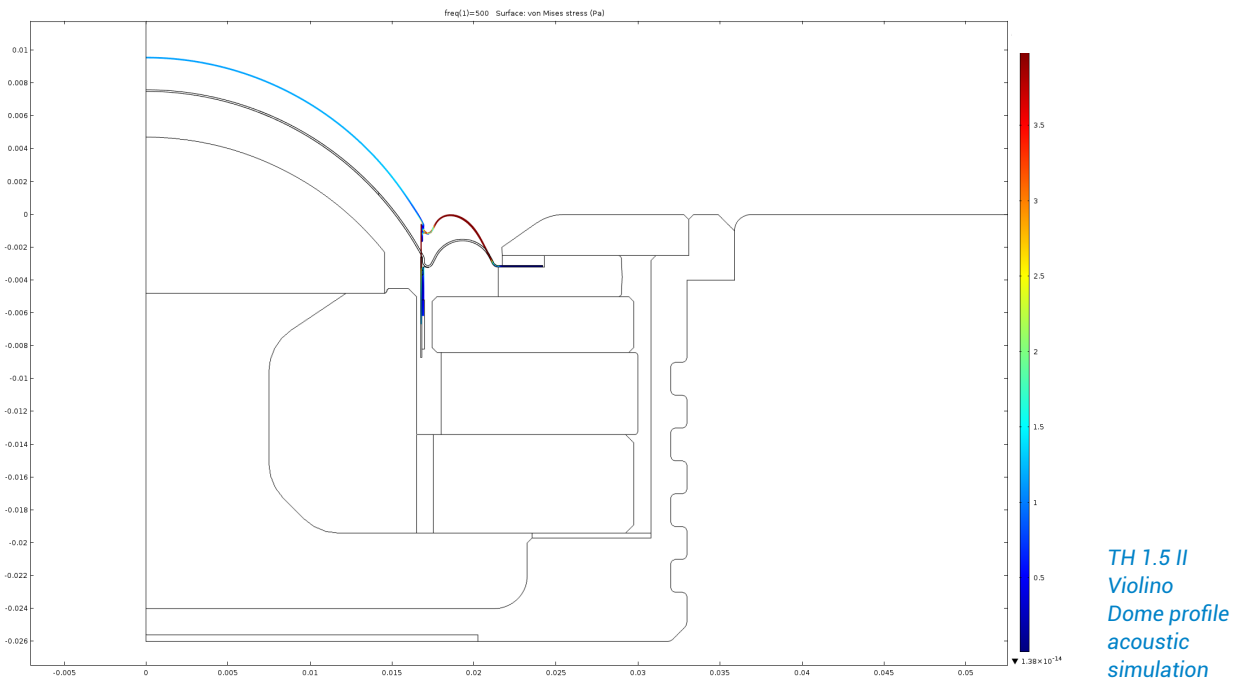

**Elettromedia**  
62018 Potenza Picena (MC) Italy  
T +39 0733 870 870 - F +39 0733 870 880  
elettromedia.com





The solidity of TH 1.5 II is also well noticeable in its mechanical all-metal structure, for a considerable weight of 370 g. Each part was designed exclusively for the TH 1.5 II, screws included.

The faceplate, also made of die-cast aluminium, is a perfect example of harmony between elegance and technique.

The Audison logo, obtained from the solid, is finished with a CNC high precision machining, while the radial profile of the faceplate is engineered for minimum acoustic impact ensuring optimal frequency dispersion.

Unparalleled low-frequency roll-off has been achieved by a sophisticated air-loading system. A high precision aluminium die-cast bottom case offers an electro-acoustic load to lower the system total compliance for a resonance frequency below 800Hz.

Twelve radial vents around the T-yoke center hole guarantee uniform pressure between the gap chamber and the bottom case. A high density porous absorber under the dome combined with a disc of compressed felt minimizes the resonances caused by internal geometries for a smooth frequency response over the whole range.

All these measures result in an incredibly natural low-midrange reproduction and allow for crossover point with woofer starting as low as 1.5 kHz/ 12dB Oct.

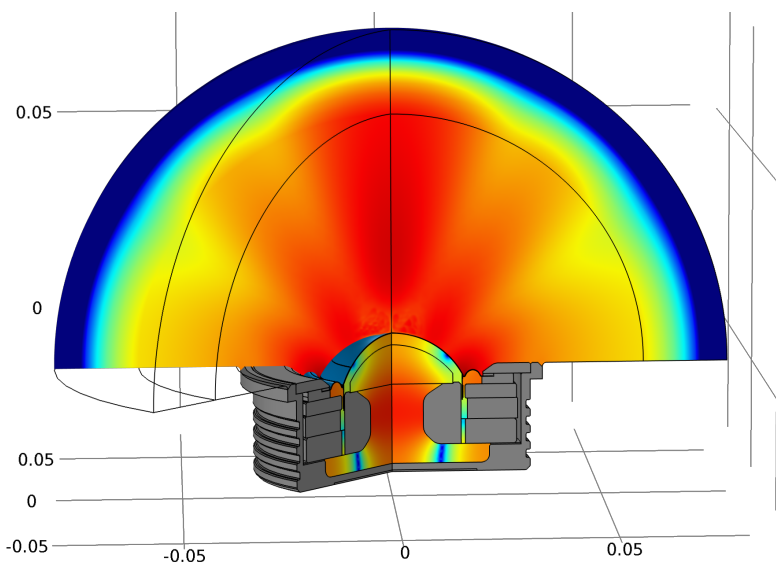

Vibro-acoustic simulation of TH 1.5 II dome assembly including air-loading effect.



All efforts in the design would have been vain if the industrialization of assembly processes had not been obsessive. **The dome/coil combination encompasses the real "heart" of the TH 1.5 II**, for this reason its assembly is totally independent from the rest of the production, in a high automation department, using a high-density support reinforced with glass fibers.

Allowing a 34mm diameter coil to extend at high frequency up to 26 kHz would have been unthinkable unless supported by an exhausting phase of tuning of the dome/former junction coupling, both in terms of choice of glue and geometry. **A special hi-technology glue is applied using 3D robotic systems to ensure high repeatability of glue quantity and perimeter of application.**

All along the assembly phase over 20 assembly jigs ensure repeatability of the process culminating in a 4 steps testing using the Klippel QC integrated in the eID system.

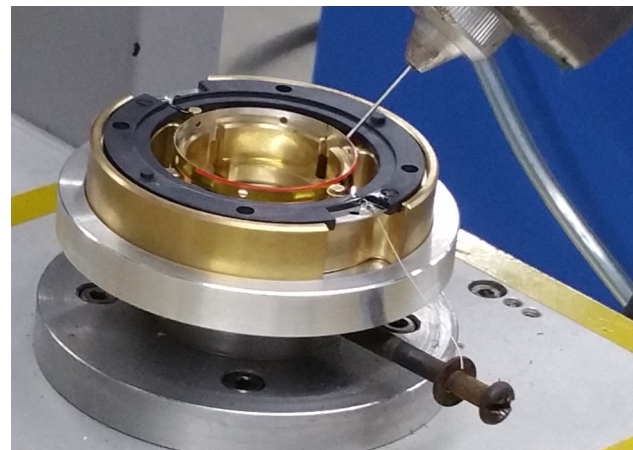

TH 1.5 II Dome/VC gluing

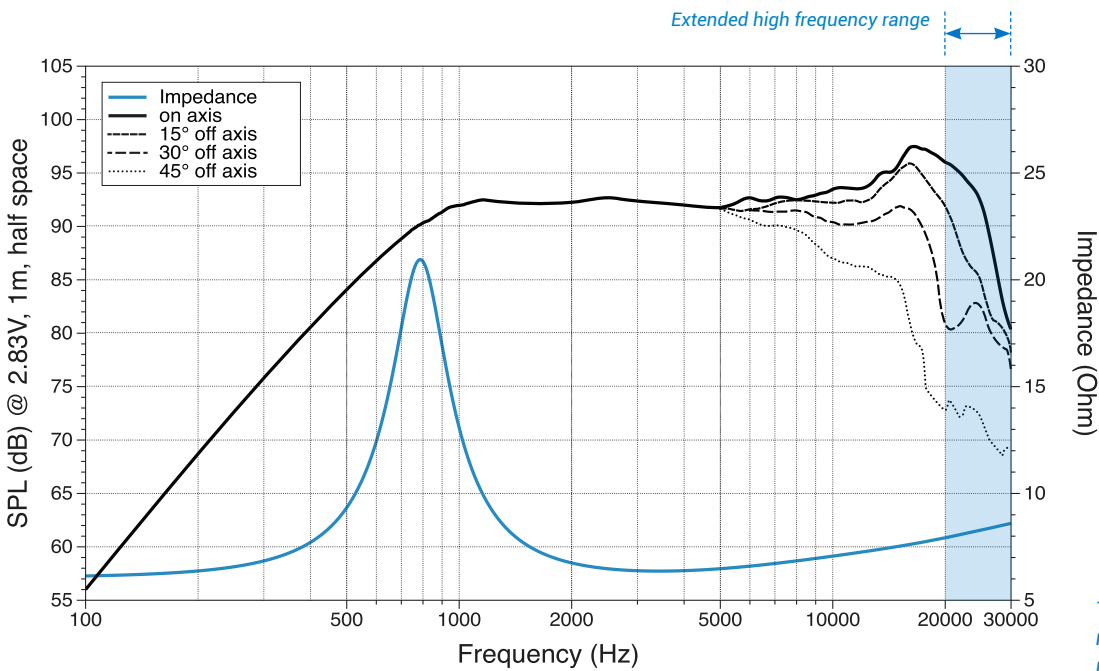

TH 1.5 II Violino multi-axis frequency response



# TH 1.5 II VIOLINO TUNING SYSTEM

The TH 1.5 II tweeter has been developed according to targets of highest performance as well as flexibility of in-car integration. This is why the R&D has offered two types of electro-acoustic load: bottom case or bottom disk.

By using the bottom case the low frequency response of the tweeter further extends so that the crossover point with the woofer can be lowered, for the benefit of the acoustic scene. When space is limited, the bottom case can be removed and space saved using the bottom disk, while still maintaining a high-performance level.



TH 1.5 II Violino bottom case & bottom disk installation

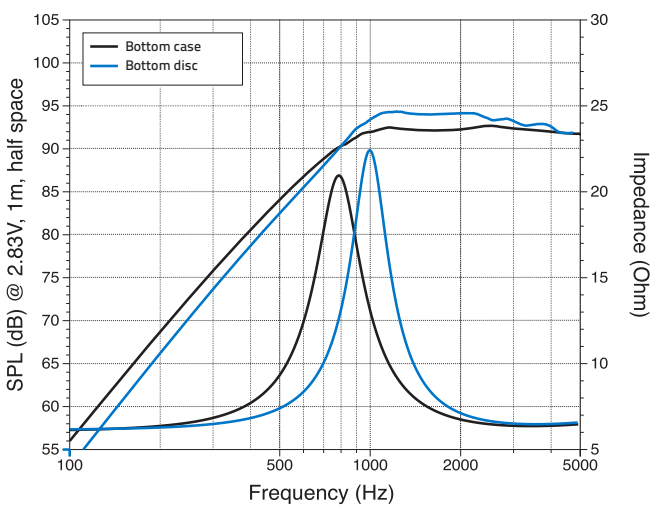

TH 1.5 II low frequency response with bottom case/ bottom disk options



## TH 3.0 II VOCE

The human auditory system processes the range of medium frequencies with maximum sensitivity and selectivity because it makes the voice intelligible from the rest of the audio spectrum.

The R&D team started from this simple principle to design a speaker dedicated to this fundamental range of frequencies from scratch, with the simple as well as ambitious target of extreme linearity, in order not to add or hide anything of the signal reproduced, enhancing in this way every nuance.



*\*THG 1.5 II, THG 3.0 II,  
THG 6.5 II mesh grilles  
are optional*





## TH 6.5 II SAX

### TOTAL TRANSPARENCY

The TH 6.5 II sax was born from a blank sheet with the aim of overcoming all the limits dictated by compromise-oriented design choices.

This philosophy allowed us to obtain extreme performance and a design projected into the future, faithful to the inspiring principle of maximum transparency of the musical message.



*\*THG 1.5 II, THG 3.0 II,  
THG 6.5 II mesh grilles  
are optional*







**MAXIMUM LINEARITY, MINIMUM INDUCTANCE, EXCELLENT VENTILATION**

TH 3.0 II Voce and TH 6.5 II Sax both feature **N38 and N48 "H-grade" Neodymium magnets**, releasing a very high quantity of energy and ultra stable in temperature, ensuring an unparalleled dynamic.

The geometry of the magnetic group has been optimized through a finite element simulation software to maximize efficiency by concentrating the magnetic field in the gap.

A great deal of research has been carried out to reduce the modulation of the voice coil inductance by magnetically saturating the motor pole and using an aluminium short-circuit ring that also allows a greater extension towards the mid frequencies.

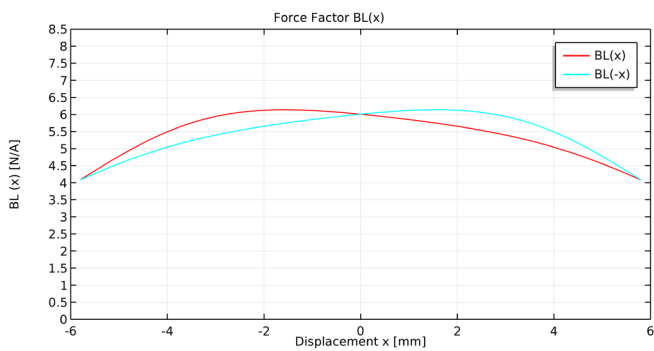

Typical competitor woofer force factor

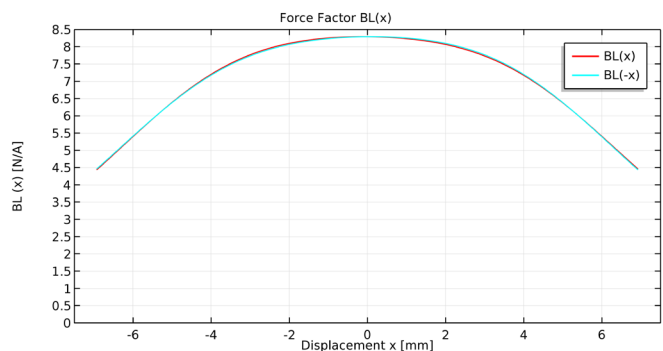

TH 6.5 II Sax force factor

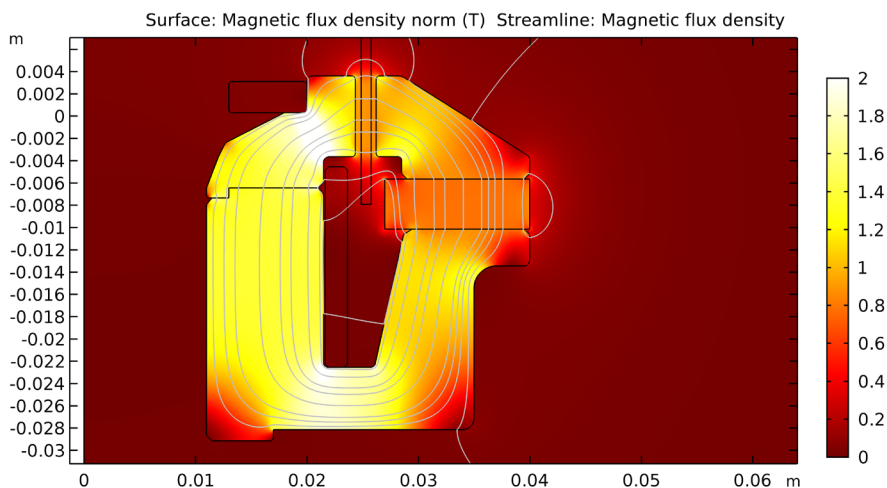

TH 6.5 II Sax magnetic flux density



**TOTAL ABSENCE OF MECHANICAL COMPRESSION**

The development of the suspension system, a crucial element for each transducer, required a long research work: **the development team created computational models to simulate every aspect of the multi-physical behavior of the loudspeaker.**

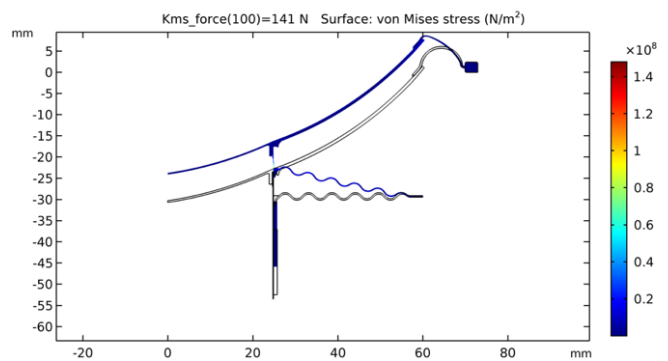
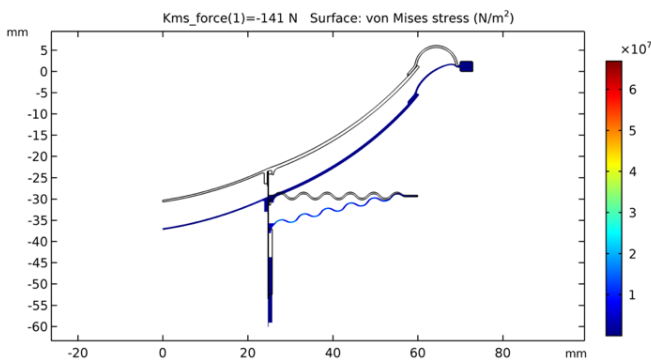
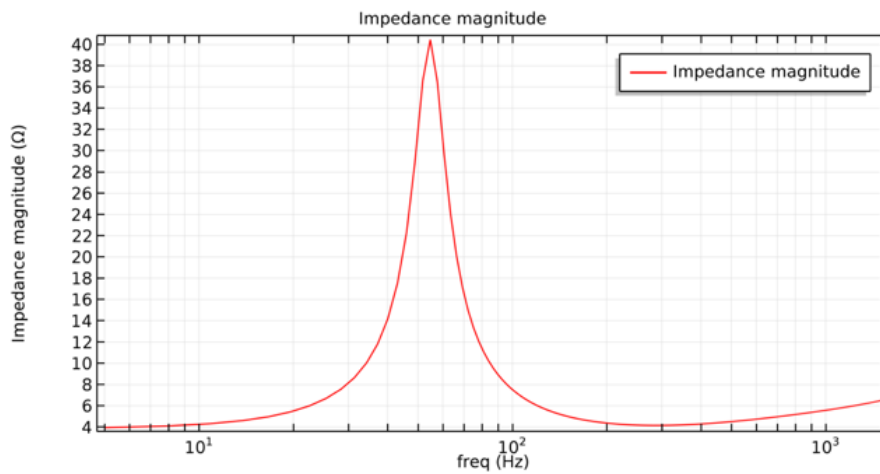

**Elettromedia**  
62018 Potenza Picena (MC) Italy  
T +39 0733 870 870 - F +39 0733 870 880  
elettromedia.com



All specifications subject to change without notice\_20.A



The spiders were designed thanks to a long series of mechanical simulations performed to define its structure: a large elastic surface with 5 waves, **ensuring an improved distribution of the elastic force**; waves profile and gluing optimized **to obtain the best symmetry in the voice coil and basket connection areas**; spider composition made of a **mix of two fibers to achieve the best elastic linearity**, without mechanical compression effects even at high excursion levels.

Like the spider, the surround was also designed using mechanical simulations. The result is guaranteed by: **use of natural rubber IIR**; **profile optimized to ensure wide excursion**; **maximization of linear elastic behavior without mechanical compression effects**.



#### TOTAL ABSENCE OF THERMAL COMPRESSION

TH 3.0 II Voce and TH 6.6 II Sax feature respectively a 30,5 and a 50 mm mobile coil in CCAR (Copper Clad Aluminum Ribbon), wound with flat wire to obtain a very compact winding, maximizes the force factor and at the same time allows for optimal heat dissipation.

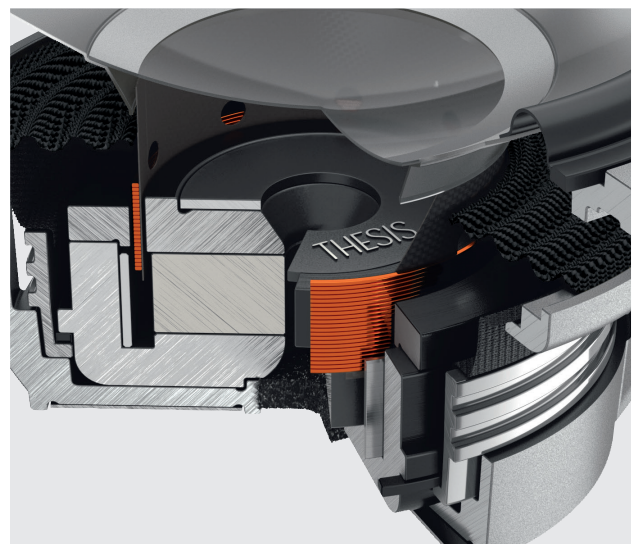

All specifications subject to change without notice\_20.A



TH 3.0 II Sax exploded view

TH 6.5 II Sax exploded view

**TOTAL ABSENCE OF AERODYNAMIC COMPRESSION**

The mechanical structure of the TH 6.5 II is a perfect combination of design and performance. The aluminium alloy basket incorporates all the components ensuring high precision in the various couplings.

The structure featuring four pairs of spokes allows for solidity and damping of the vibrations offering very low resistance to the cone air flow. The wide spider distributes the elastic load optimally. A generously sized hole, protected by a filter cloth, prevents air compression phenomena under the spider, eliminating deleterious resonance at medium frequencies.

The central opening in the bottom-plate ensures **optimal decompression of the air column inside the voice coil** and the output expanded material diffuses the turbulences and protects it from ingoing foreign bodies.



**Elettromedia**  
62018 Potenza Picena (MC) Italy  
T +39 0733 870 870 - F +39 0733 870 880  
elettromedia.com





### TPX® CONE

The R&D team selected **TPX® thermoplastic polymer, with excellent acoustic and mechanical features**. More specifically, its low density and its high mechanical damping contribute **to produce an exceptionally smooth frequency response in all possible listening positions**.

Being transparent, it leaves the precious Thesis diamond logo built from a solid block of aluminium in full view.

**TPX® is injection molded, a technique that has made it possible to create a variable thickness profile, which gives the structure even more rigidity.**

Taking advantage of innovative finite element calculation methods that allow the simulation of **the speaker overall vibro-acoustic performance**, the R&D team designed a monolithic cone (one block including diaphragm and dustcap), obtaining an **extremely rigid structure with a single gluing point with the voice coil** (unlike the two traditional cone-coil, dustcap-cone). This particular structure allows the cone vibration modes to be "moved" (i.e. the frequencies in which the cone is deformed introducing irregularities in the frequency response) as much as possible towards the high frequency range, **leaving the entire mid-frequency band free from irregularities: this provides the speaker with an extremely transparent and detailed "voice" in the mid-range.**

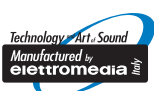
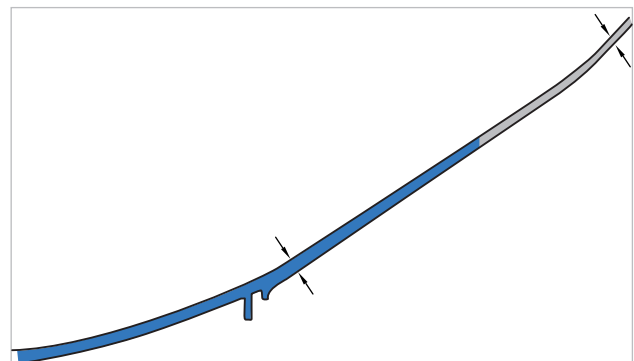
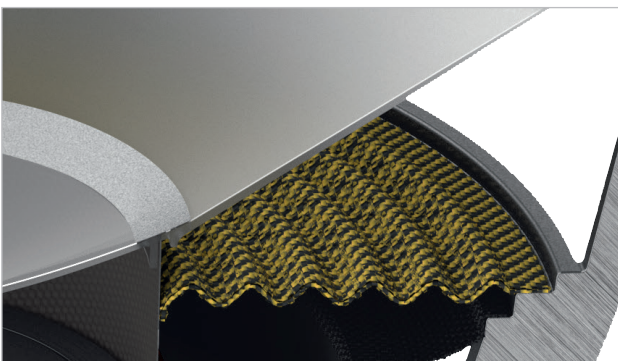
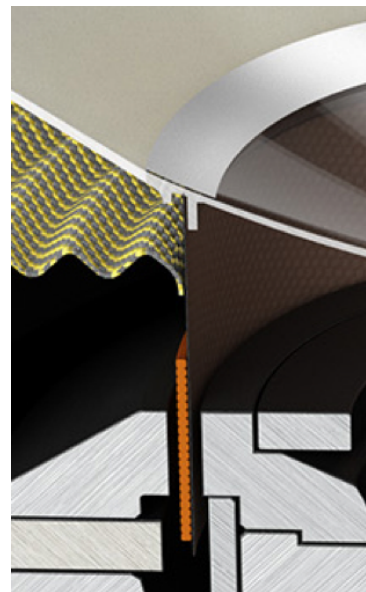

**Elettromedia**  
62018 Potenza Picena (MC) Italy  
T +39 0733 870 870 - F +39 0733 870 880  
elettromedia.com





**TH 3.0 II Sax DIRECTIVITY PATTERN**

TH 3.0 II Voce is a pure mid-range specialized in the reproduction of the 250 / 3.5k Hz range. It integrates perfectly with tweeters and woofers in a 3-way system **elevating the emission point in order to create an astonishing sound stage.**

The optimized force factor (BL) together with an FS lowered at 100 Hz allowed to obtain a QTS value of 0.48, ideal for a perfectly

**damped behavior in the 400-800 Hz frequency range.** All electroacoustic parameters have been optimized to **maximize performance in small volumes**, such as in A pillar and PODs installation.

The TH 3.0 II Voce directivity map is refined both on-axis and off-axis as can be seen from the response curves, a fundamental characteristic to obtain a correct and realistic reconstruction of **the sound stage in the car cabin.**

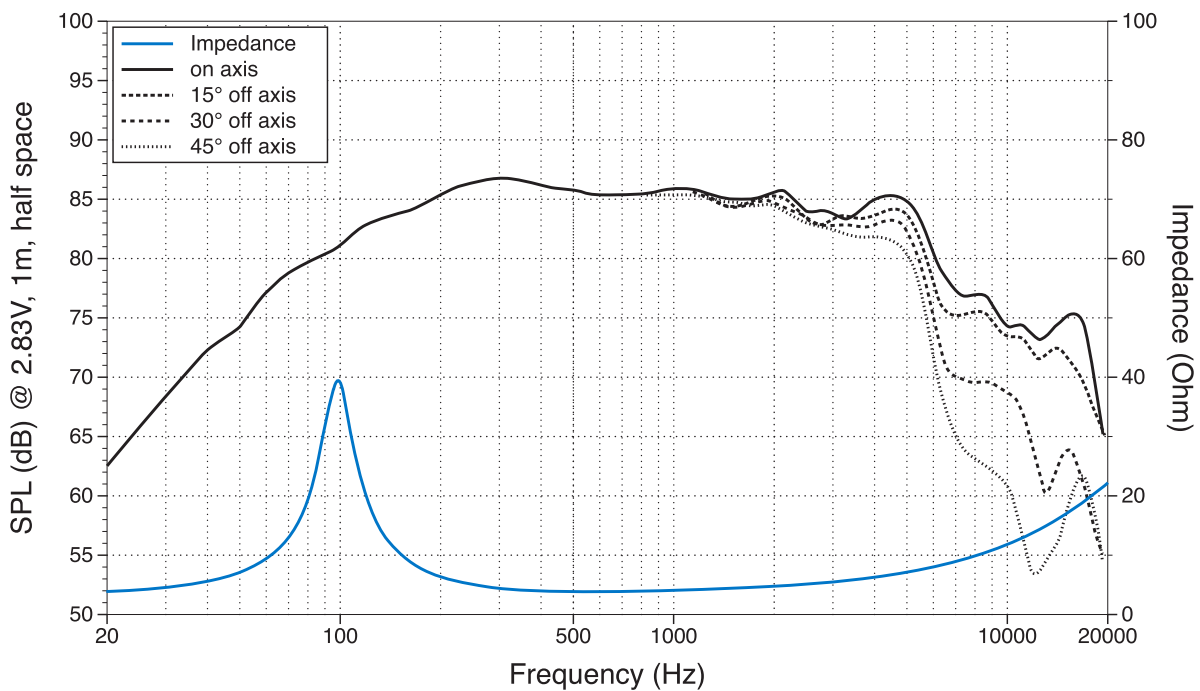

**TH 6.5 II Sax DIRECTIVITY PATTERN**

Producing the frequency response as smooth as possible in all listening positions (in axis, off-axis, any direction), this is the ambitious goal of our designers, pursued by optimizing the map of the woofer directivity, to obtain an acoustic energy distribution without distortion in the frequency response both in axis and off-axis.

This allows the TH 6.5 II to play optimally when in-door mounted, a condition in which the listener is not aligned with the speaker.

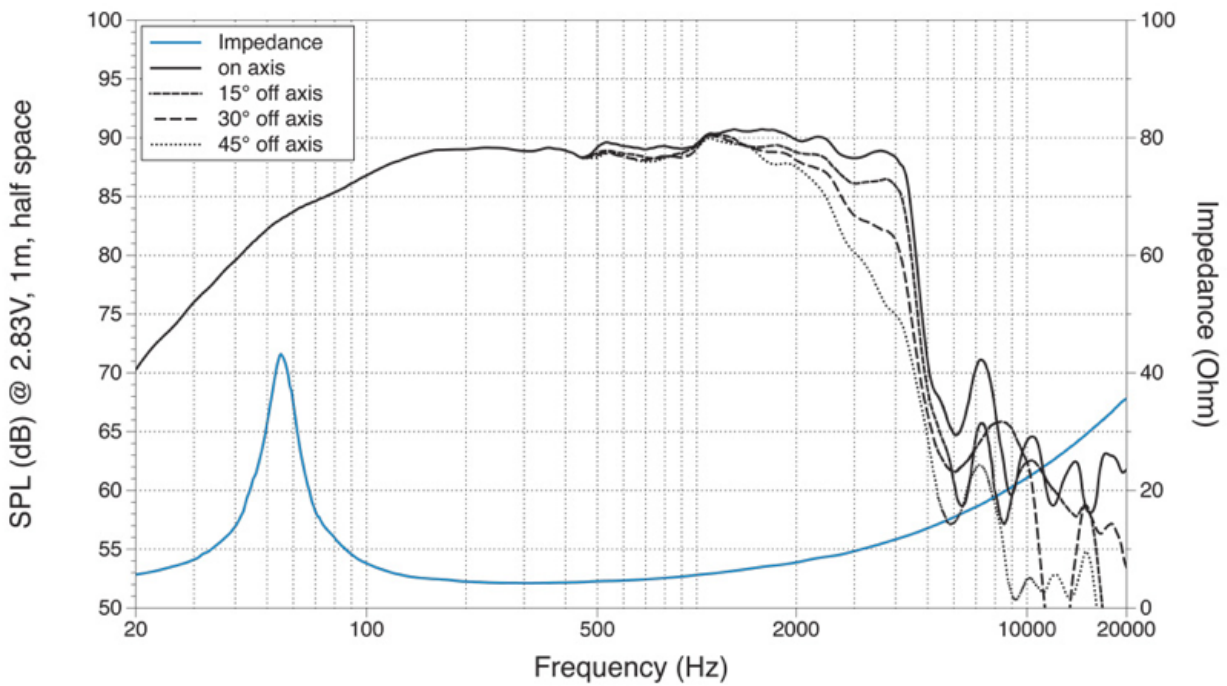

All specifications subject to change without notice\_20.A



# TH K2 II CORO A SYSTEM



*"Audison's no-nonsense approach means that the TH K2 II A Coro eschews fripperies and instead employs the very best materials for the job at hand. This two-way kit comprises a 165mm cone woofer and 38mm dome tweeter, both featuring over-sized neodymium magnet assemblies to extend response and dynamics as far as possible. All design and engineering parameters are pushed to the very max, and with a 24-month development period for each drive unit, Audison's efforts have clearly borne fruit. These spectacular drivers are perfectly equipped for partnering with modern DSP technology, and ready to action the smallest adjustment to any setting."*

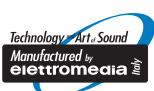

**Elettromedia**  
62018 Potenza Picena (MC) Italy  
T +39 0733 870 870 - F +39 0733 870 880  
elettromedia.com







The versatility of the TH 1.5 II and TH 6.5 II provides the ability for the user to set the crossover cut in a very wide range according to his preferences. This is possible thanks to the exceptional extension of the tweeter frequency response towards the medium frequencies (800 - 22 kHz) and to the very regular response of the woofer at medium-high frequencies (up to 4 kHz). Thanks to this versatility we have designed two cut-off options.

**SUGGESTED FILTER OPTIONS**

The two recommended filter configurations have been designed starting from **boundary elements simulations (BEM)** and validated through listening tests in different configurations with expert listeners.

**1. Best Envelopment:** sound stage optimized for listeners who prefer to have a well-distributed vertical scene along the entire height of the passenger compartment.

**Tweeter setup:** High-pass 2.75 kHz 12 dB / oct, Butterworth, level from -6 to -8 dB

**Woofer setup:** Low-pass 2.5 kHz 6 dB / oct, Butterworth, level 0 dB

**2. Best Focus:** sound stage optimized for listeners who prefer a well-focused vertical acoustic scene at the high end of the dashboard and a very wide horizontal one.

**Tweeter setup:** High-pass 1.25 kHz 12 dB/oct, Linkwitz-Riley, level from -7 to -9 dB

**Woofer setup:** Low-pass 1.25 kHz 12 dB/oct, Linkwitz-Riley, level 0 dB

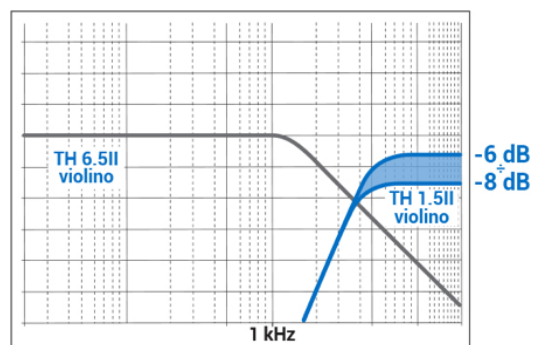
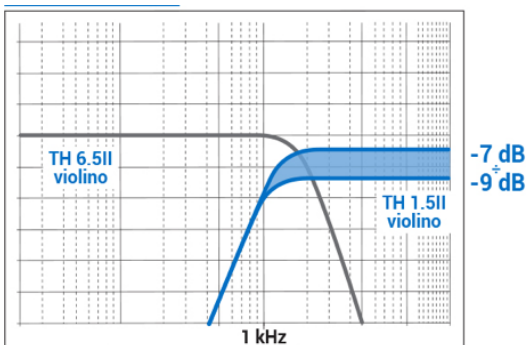
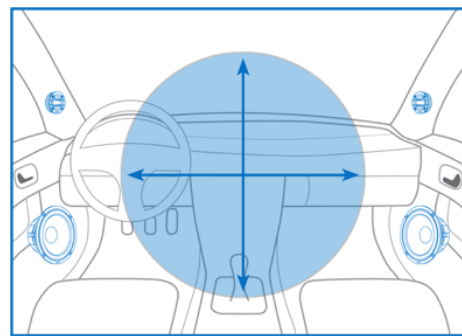
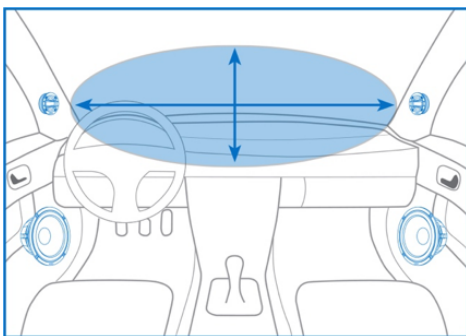



## TH K2 II CORO PASSIVE



For the enthusiasts who prefer to use a passive filter, the R&D team has created THX 2 II, a crossover engineered without compromise with the use of high quality resistors, capacitors and inductors. The filter, for both woofer and tweeter, has special compensation networks that optimize the load seen by the amplifier. The filtering configuration originates from the active Best Envelopment configuration and allows the following fine-tuning options to improve the performance in the passenger compartment:

- 4 emission levels for the tweeter (-4, -2, 0, +1,5 dB), designed with L-Pad technique
- mid-frequency level control (-3 -> 0 dB) centered at 900 Hz to vary the sound character from the analytical one obtained from professional monitors to the softer one typical of the most sophisticated home systems.
- possibility of bi-amplification



## TH K3 II A ORCHESTRA



The experience of listening to a full orchestra in a prestigious theater remains well-impressed throughout life. For this reason we have called the maximum three-way Thesis system Orchestra, to evoke an exceptional event that generates extraordinary pleasure.



All specifications subject to change without notice\_20.A

SUGGESTED FILTER OPTIONS

TH K3 II A ORCHESTRA system delivers maximum performance in active multi-amplification by exploiting the linear phase crossover FIR filters available in the two flagship processors, bit One HD and bit One HD Virtuoso.



Tweeter Setup

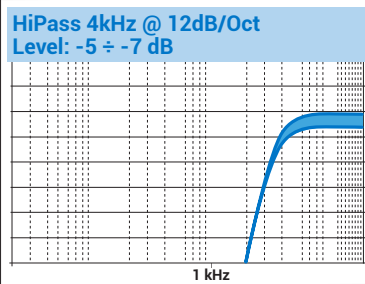

**ATTENTION:**  
Tweeter phase must be reversed by DSP setting for this set-up.

TH 1.5 II  
Violino

Midrange Setup

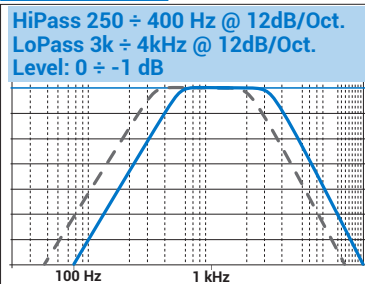

TH 3.0 II  
Voce

Woofers Setup

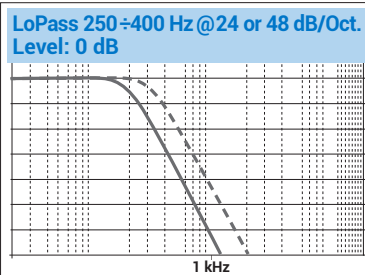

TH 6.5 II  
Sax



## EID TECHNOLOGY

Thesis speakers are the first to develop into **eID, the exclusive technology** providing Audison product traceability starting from the manufacturing stage.

The eID code, linked to the serial number, is assigned to the product once the QC checks are completed and assigned to the country/market of destination at the time of shipment. Thanks to the eID technology, the user can check the product technical, manufacturing and logistic information by simply scanning the code and proceeding with the **product registration, to enjoy one additional year of warranty coverage\***.

eID makes sure the user feels **"Beyond the Absolute"** with **Audison Thesis**.

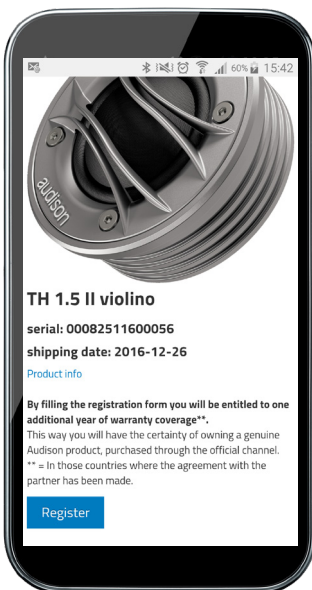

*\*in those countries with an existing agreement with the partner.*



All specifications subject to change without notice\_20.A

THESIS

THESIS  
HV venti



POWER SUPPLY		
Power supply voltage:	11 ÷ 16 VDC	
Idling current when off:	0.006 mA	
Minimum idling current:	Hi Curr.	Hi Pow.
Low BIAS	4.2A	5.6A
High BIAS	6.5A	10.4A
Consumption @ 13.8 VDC	90A(1Ω)	100A(2Ω)

AMPLIFIER STAGE		
Distortion - THD (1kHz):	<0.05%	
Distortion - IMD (IHF):	<0.05%	
Bandwidth (-3 dB):	4Hz ÷ 75 kHz	
S/N Ratio (A weighed @1 V):	100 dB	
Damping factor (1kHz, 4 Ohms):	80	
Slew rate	>20V/μs	
Input sensitivity (high):	0.25 ÷ 1.6 VRMS	
Input sensitivity (low):	1 ÷ 7 VRMS	
Input impedance:	22 kΩ	
Load impedance:	Hi Curr.	Hi Pow.
Stereo	4 - 2 - 1Ω	4 - 2Ω
Mono	4 - 2Ω	4Ω
OUTPUT POWER (RMS) @13.8 VDC; THD 1%:		
Load (dual power)	Hi Curr.	Hi Pow.
2ch 4Ω	200W	400W
2ch 2Ω	400W	800W
2ch 1Ω	650W	-
Mono 4Ω	800W	1600W
Mono 2Ω	1300W	-

MAX SIZE (L x H x D):	510 x 85 x 280 mm - 20 x 3.3 x 11 in.
WEIGHT:	15 Kg

1. Exclusive circuitry IGBT (Insulated Gate Bipolar Transistor).
2. A Class preamplifier, intermediate stages and drivers.
3. Dual Mono construction featuring four power supplies in Synchro-PWM configuration.
4. Made exclusively with discrete components.
5. Signal switching made exclusively with relays.
6. Fully balanced input circuit.
7. Power supply on separate board to eliminate interference.
8. 'Dual Power' function to switch between Hi-Current and Hi-Power.
9. 'Bias Selector' function to change the percentage in A Class.
10. High quality crossover module supplied.
11. 5 mm aluminium chassis connecting two side cooling ducts.

FILTERS / INPUTS	
Pre IN:	L/R (ABS)
Pre OUT (pre in bypass):	L/R (ABS)
Crossover frequencies	High pass & Low pass stereo 45 - 55 - 65 - 80Hz, 12dB/oct. Lo-pass mono 45 - 55 - 65 - 80Hz, 24dB/oct.

OTHER FUNCTIONS	
Remote In:	7 ÷ 16 VDC - 1 mA
Demo mode ext. supply:	12 VDC - 600 mA
Ext. Cap terminals:	18 VDC cap min
Fuse (strip):	100 A

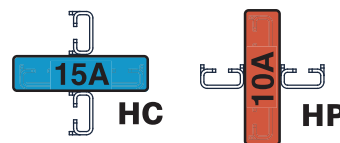

**DUAL POWER CONFIGURATION**

In order to set the amplifier in Hi Power or Hi Current mode you need to change position of the four minifuses located on four jumpers that are next to each transformer.



# TH quattro

## 1400 W Power Amplifier



POWER SUPPLY	
Voltage:	11 ÷ 15 VDC
Idling current (@ Dual Power Setting):	2.6 ÷ 8.9 A
Idling current when off:	0.04 mA
Consumption @ 14.4 VDC, 1 Ω, Max Musical Power:	105 A
Remote In:	7 ÷ 15 VDC (1 mA)
Remote Out :	12 VDC (20 mA)
Fuse (AFS):	100 A

AMPLIFIER STAGE			
Distortion - THD @ 1 kHz, 4 Ω; 90% Power:		0.03 %	
Bandwidth @ -3 dB, 2 VRMS, 4 Ω:		5 ÷ 70k Hz	
S/N ratio @ A weighted, 1 V, Max Power:		104 dBA	
Damping factor @ 1 kHz, 2 VRMS, 4 Ω:		80	
Pre-In sensitivity (two ranges):		0.3 ÷ 4.8 VRMS	
Pre-In impedance:		15 kΩ	
Load impedance (Min @ Dual Power Mode - Hi-Current):		4 Ch	1 Ω
		2 Ch	2 Ω
Output power (RMS) @ 14.4 VDC, 1% THD:	Dual Power Mode - Hi Current:	4 Ch @ 4 Ω	160 W x 4
		4 Ch @ 2 Ω	260 W x 4
		4 Ch @ 1 Ω	340 W x 4
		3 Ch @ 4 Ω	150 W x 2 + 540 w x 1
		3 Ch @ 2 Ω	250 w x 2 + 650 w x 1
		2 Ch @ 4 Ω	500 W x 2
Dual Power Mode - A Class:		2 Ch @ 2 Ω	700 W x 2
		4 Ch @ 4 Ω	55 W x 4

CEA SPECIFICATIONS	
	Output power @ 4Ω, 1% THD+N, 14.4 V: 150 W x 4 Ch
	SN ratio (ref. 1W output): 80 dBA

1. Complementary differential circuitry with current mirror.
2. Cascode A Class driver with inverted complementary triplet power stages.
3. Integrated 24-bit / 192 kHz Hi-End DA converters.
4. Compatibility with Audison Full DA HD technology and Hi-Res audio files listening certification.
5. SPDIF and AD Link optical digital inputs that manage up to 8 digital channels on RJ-45 connector.
6. Dual Mono Construction featuring four power supplies in Synchro-PWM configuration.
7. Sensitivity control featuring 256 steps resistive switching for a resolution of 120 dB.
8. Energy Saving, Hi-Current, Hi-AB Class, A Class presets selectable in real time.
9. Digital control via integrated settings panel, DRC and PC Software.
10. High quality crossover module supplied.
11. Chassis extruded from solid aluminium and built using CNC machines.

### ASC (Audison Status Controller) FUNCTIONS

AMP Identifications, DUAL POWER settings, AD Link inputs, AC Link digital bus, DRC controls, ACNet software, Status Monitor, Protections

### INPUTS / OUTPUTS / FILTERS

Inputs:	PRE - S/PDIF (Max 192 kHz / 24 bit) Optical and AD Link
Outputs:	PRE Bypass / AD Link
Filters:	2 x Removable kits: (Hi-pass / Lo-pass / Bandpass 12/24dB) 32 steps 18 ÷ 7.5k Hz with 8 standard & 2 customizable modules

### SIZE / WEIGHT

Max size (mm/inch):	259 x 510 x 67 / 10.2 x 20 x 2.6
Weight (kg/lb):	10,3 kg / 22.71

All specifications subject to change without notice\_20.A



**Elettromedia**  
62018 Potenza Picena (MC) Italy  
T +39 0733 870 870 - F +39 0733 870 880  
elettromedia.com

audison



# TH quattro

1400 W Power Amplifier

**A CH AMP    B CH AMP    PRE OUT**

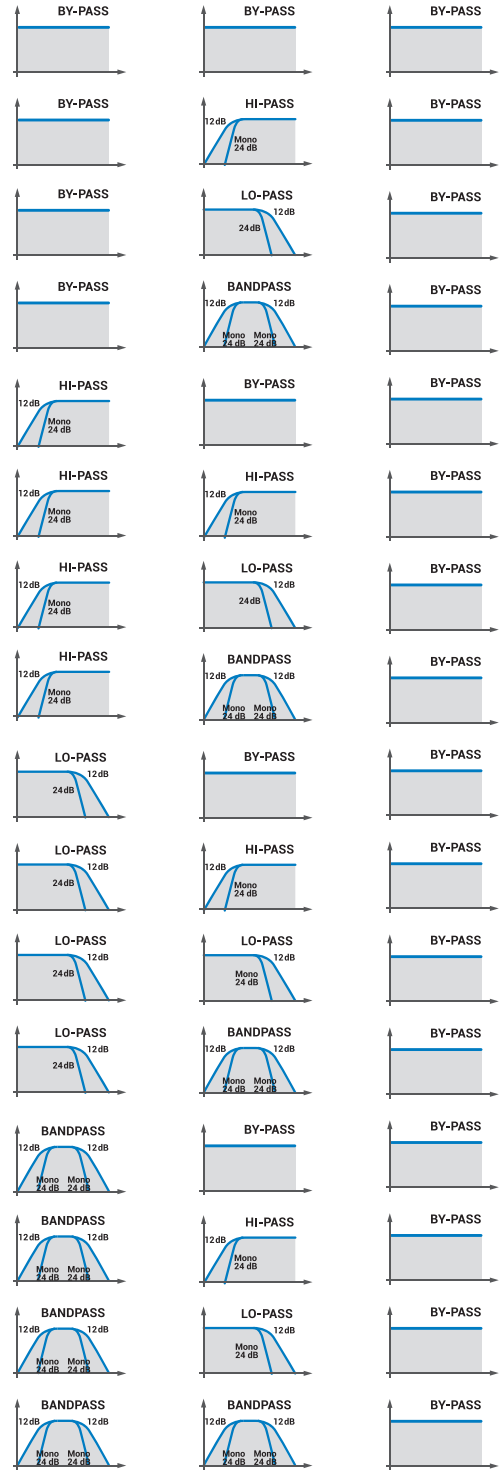

CROSSOVER MODULES	
ITEM	VALUES
SS1:	18-22-27-33 Hz
SW1:	42-50-60-75 Hz
SW2:	90-110-130-150 Hz
WM1:	180-220-270-330 Hz
WM2:	420-500-600-750 Hz
WT1:	880-1k1-1k3-1k5 Hz
WT2:	1k8-2k2-2k7-3k3 Hz
MT1:	4k2-5k0-6k0-7k5 Hz

DUAL POWER SETTINGS			
SET	BIAS	POWER	MIN LOAD
A Class	Very High	Normal	4Ω
Hi-AB Class	High	High	4-2Ω
Hi-Current	Standard	High	4-2-1Ω
Energy Saving	Low	Normal	4-2-1Ω

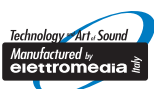

**Elettromedia**  
62018 Potenza Picena (MC) Italy  
T +39 0733 870 870 - F +39 0733 870 880  
elettromedia.com



All specifications subject to change without notice\_20.A





# TH quattro

1400 W Power Amplifier

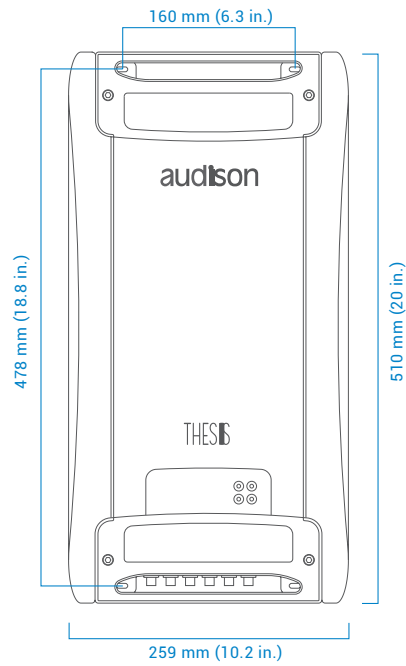

## SYSTEM DESIGN EXAMPLE

2 WAY FRONT + SUBWOOFER INPUTS ANALOG + DIGITAL

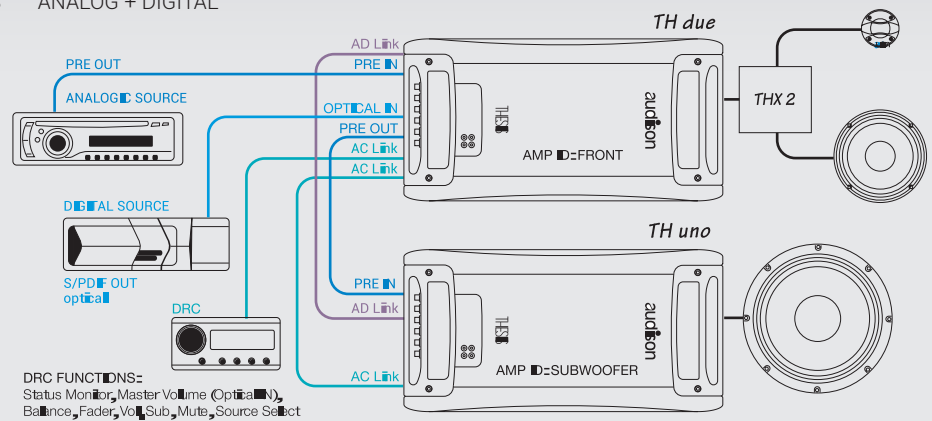

THESIS



# TH due

## 1500 W Power Amplifier



POWER SUPPLY	
Voltage:	11 ÷ 15 VDC
Idling current (@ Dual Power Setting):	2.0 ÷ 7.4 A
Idling current when off:	0.04 mA
Consumption @ 14.4 VDC, 1 Ω, Max Musical Power:	105 A
Remote In:	7 ÷ 15 VDC (1 mA)
Remote Out :	12 VDC (20 mA)
Fuse (AFS):	100 A

AMPLIFIER STAGE		
Distortion - THD @ 1 kHz, 4 Ω; 90% Power:	0.02 %	
Bandwidth @ -3 dB, 2 VRMS, 4 Ω:	5 ÷ 70k Hz	
S/N ratio @ A weighted, 1 V, Max Power:	106 dBA	
Damping factor @ 1 kHz, 2 VRMS, 4 Ω:	100	
Pre-In sensitivity (two ranges):	0.3 ÷ 4.8 VRMS	
Pre-In impedance:	15 kΩ	
Load impedance (Min @ Dual Power Mode - Hi-Current):	2 Ch @ 1 Ω 1 Ch @ 2 Ω	
Output power (RMS) @ 14.4 VDC, 1% THD:	Dual Power Mode - Hi Current:	2 Ch @ 4 Ω 300 W x 2 2 Ch @ 2 Ω 500 W x 2 2 Ch @ 1 Ω 750 W x 2 1 Ch @ 4 Ω 1000 W x 1 1 Ch @ 2 Ω 1500 W x 1
	Dual Power Mode - A Class:	2 Ch @ 4 Ω 80 W x 2

CEA SPECIFICATIONS	
	Output power @ 4Ω, 1% THD+N, 14.4 V: 300 W x 2 Ch
	SN ratio (ref. 1W output): 80 dBA

1. Complementary differential circuitry with current mirror.
2. Cascode A Class driver with inverted complementary triplet power stages.
3. Integrated 24-bit / 192 kHz Hi-End DA converters.
4. Compatibility with Audison Full DA HD technology and Hi-Res audio files listening certification.
5. SPDIF and AD Link optical digital inputs that manage up to 8 digital channels on RJ-45 connector.
6. Dual Mono Construction featuring four power supplies in Synchro-PWM configuration.
7. Sensitivity control featuring 256 steps resistive switching for a resolution of 120 dB.
8. Energy Saving, Hi-Current, Hi-AB Class, A Class presets selectable in real time.
9. Digital control via integrated settings panel, DRC and PC Software.
10. High quality crossover module supplied.
11. Chassis extruded from solid aluminium and built using CNC machines.

ASC (Audison Status Controller) FUNCTIONS
AMP Identifications, DUAL POWER settings, AD Link inputs, AC Link digital bus, DRC controls, ACNet software, Status Monitor, Protections

INPUTS / OUTPUTS / FILTERS	
Inputs:	PRE - S/PDIF (Max 192 kHz / 24 bit) Optical and AD Link
Outputs:	PRE Bypass / AD Link
Filters:	Removable kit: (Hi-pass / Lo-pass / Bandpass 12/24dB) 32 steps 18 ÷ 7.5k Hz with 8 standard & 2 customizable modules

SIZE / WEIGHT	
Max size (mm/inch):	259 x 510 x 67 / 10.2 x 20 x 2.6
Weight (kg/lb):	10,3 kg / 22.71



# TH due

1500 W Power Amplifier

CROSSOVER MODULES	
ITEM	VALUES
SS1:	18-22-27-33 Hz
SW1:	42-50-60-75 Hz
SW2:	90-110-130-150 Hz
WM1:	180-220-270-330 Hz
WM2:	420-500-600-750 Hz
WT1:	880-1k1-1k3-1k5 Hz
WT2:	1k8-2k2-2k7-3k3 Hz
MT1:	4k2-5k0-6k0-7k5 Hz

DUAL POWER SETTINGS			
SET	BIAS	POWER	MIN LOAD
A Class	Very High	Normal	4Ω
Hi-AB Class	High	High	4-2Ω
Hi-Current	Standard	High	4-2-1Ω
Energy Saving	Low	Normal	4-2-1Ω

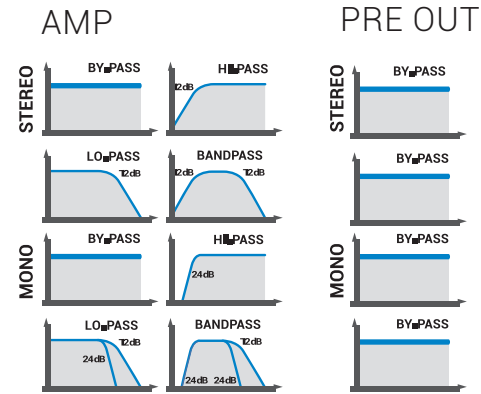
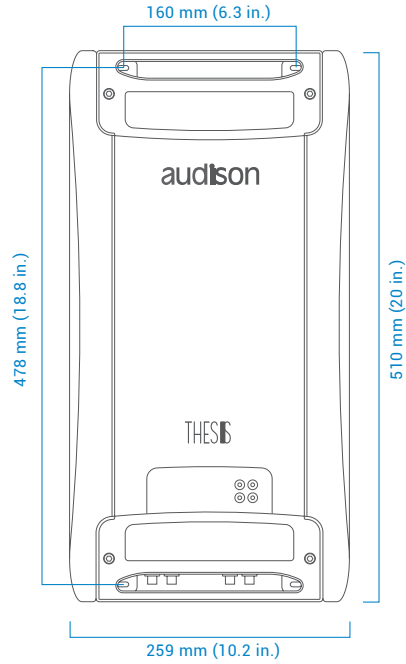

## SYSTEM DESIGN EXAMPLE

2 WAY FRONT + SUBWOOFER INPUTS ANALOG + DIGITAL

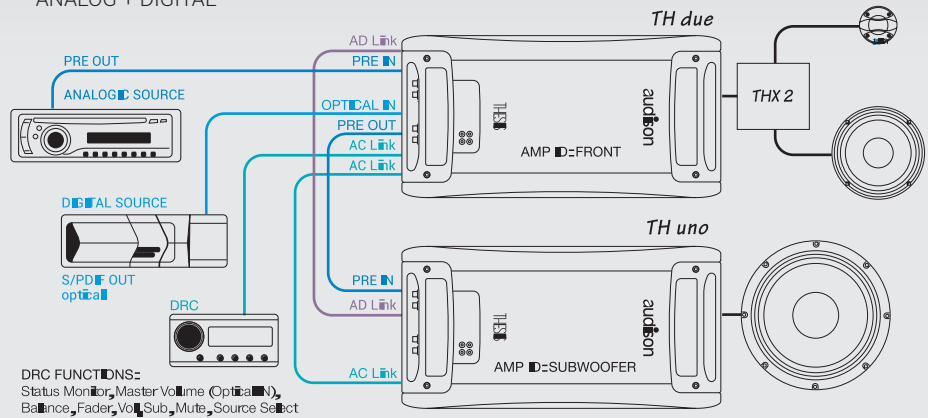





## TH uno

2300 W Power Amplifier



POWER SUPPLY	
Voltage:	11 ÷ 15 VDC
Idling current (@ Dual Power Setting):	2.2 ÷ 8.5 A
Idling current when off:	0.04 mA
Consumption @ 14.4 VDC, 1 Ω, Max Musical Power:	132 A
Remote In:	7 ÷ 15 VDC (1 mA)
Remote Out :	12 VDC (20 mA)
Fuse (AFS):	150 A

AMPLIFIER STAGE			
Distortion - THD @ 1 kHz, 4 Ω; 90% Power:		0.01 %	
Bandwidth @ -3 dB, 2 VRMS, 4 Ω:		5 ÷ 40k Hz	
S/N ratio @ A weighted, 1 V, Max Power:		106 dBA	
Damping factor @ 1 kHz, 2 VRMS, 4 Ω:		500	
Pre-In sensitivity (two ranges):		0.3 ÷ 4.8 VRMS	
Pre-In impedance:		15 kΩ	
Load impedance (Min @ Dual Power Mode - Hi-Current):		1 Ch	1 Ω
Output power (RMS) @ 14.4 VDC, 1% THD:	Dual Power Mode - Hi Current:	1 Ch @ 4 Ω	850 W x 2
		1 Ch @ 2 Ω	1500 W x 1
	1 Ch @ 1 Ω	2300 W x 1	
	Dual Power Mode - A Class:	1 Ch @ 4 Ω	200 W x 1
Amp Chain Mode (two linked amplifiers):	4 Ω	3000 W	
	2 Ω	4500 W	

CEA SPECIFICATIONS	
	Output power @ 4Ω, 1% THD+N, 14.4 V: 700 W x 1 Ch
	SN ratio (ref. 1W output): 75 dBA

ASC (Audison Status Controller) FUNCTIONS
AMP IDentifications, DUAL POWER settings, AD Link inputs, AC Link digital bus, DRC controls, ACNet software, Status Monitor, Protections

1. Complementary differential circuitry with current mirror.
2. Cascode A Class driver with inverted complementary triplet power stages.
3. Integrated 24-bit / 192 kHz Hi-End DA converters.
4. Compatibility with Audison Full DA HD technology and Hi-Res audio files listening certification.
5. SPDIF and AD Link optical digital inputs that manage up to 8 digital channels on RJ-45 connector.
6. Dual Mono Construction featuring four power supplies in Synchro-PWM configuration.
7. Sensitivity control featuring 256 steps resistive switching for a resolution of 120 dB.
8. Energy Saving, Hi-Current, Hi-AB Class, A Class presets selectable in real time.
9. Digital control via integrated settings panel, DRC and PC Software.
10. High quality crossover module supplied.
11. Chassis extruded from solid aluminium and built using CNC machines.

INPUTS / OUTPUTS / FILTERS	
Inputs:	PRE - S/PDIF (Max 192 kHz / 24 bit Optical and AD Link
Outputs:	PRE Bypass / AD Link
Filters:	Removable kit: (Hi-pass / Lo-pass / Bandpass 12/24dB) 32 steps 18 ÷ 7.5k Hz with 8 standard & 2 customizable modules
Special Function (Linked Amplifiers):	Master/Slave Bridged; Slave Chain

SIZE / WEIGHT	
Max size (mm/inch):	259 x 510 x 67 / 10.2 x 20 x 2.6
Weight (kg/lb):	10,3 kg / 22.71

All specifications subject to change without notice\_20A



# TH uno

2300 W Power Amplifier

CROSSOVER MODULES	
ITEM	VALUES
SS1:	18-22-27-33 Hz
SW1:	42-50-60-75 Hz
SW2:	90-110-130-150 Hz
WM1:	180-220-270-330 Hz
WM2:	420-500-600-750 Hz
WT1:	880-1k1-1k3-1k5 Hz
WT2:	1k8-2k2-2k7-3k3 Hz
MT1:	4k2-5k0-6k0-7k5 Hz

DUAL POWER SETTINGS			
SET	BIAS	POWER	MIN LOAD
A Class	Very High	Normal	4Ω
Hi-AB Class	High	High	4-2Ω
Hi-Current	Standard	High	4-2-1Ω
Energy Saving	Low	Normal	4-2-1Ω

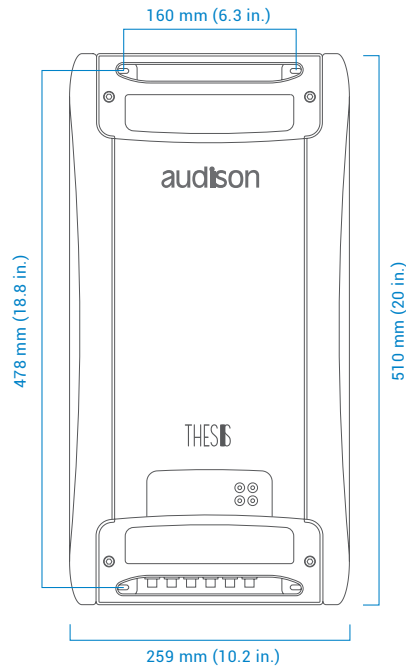

### AMP

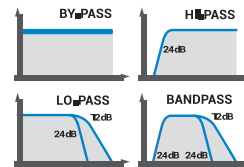

### PRE OUT

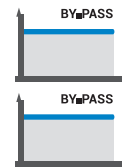

## SYSTEM DESIGN EXAMPLE

2 WAY FRONT + SUBWOOFER INPUTS ANALOG + DIGITAL

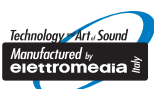
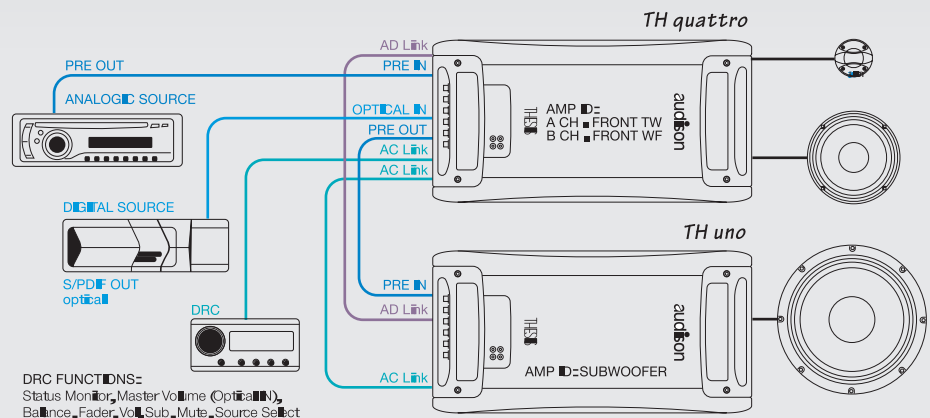

**Elettromedia**  
62018 Potenza Picena (MC) Italy  
T +39 0733 870 870 - F +39 0733 870 880  
elettromedia.com





# TH 1.5 II Violino

200 W Max Power



TECHNICAL SPECIFICATIONS		
Component		Tweeter
Tweeter diaphragm	mm (in.)	38 (1.5)
Voice Coil Ø		34 (1.34)
Power Handling	W peak	200 (Hi-Pass filtered @ 1,8kHz - 12 dB Oct.)
Impedance	Ω	6
Frequency Response	Hz	800 ÷ 26k
Magnet size D x d x h	mm (in.)	60 x 36 x 5 (2.36 x 1.42 x 0.2)
Weight of one speaker	kg (lb.)	0.355 (0.78)
Magnet		Neodymium
Dome/Cone		Tetolon

ELECTRO-ACOUSTIC PARAMETERS			
		Bottom case	Bottom disk
D	mm	38	38
Re	Ω	6,1	6,1
Fs	Hz	780	980
Le	mH	0,025	0,025
Vas	l	0,019	0,013
Mms	g	0,43	0,43
Cms	mm/N	0,09	0,062
BL	T·m	3,32	3,44
Qts		0,83	0,97
Qes		1,2	1,3
Qms		2,9	3,5
Spl	dB	92,5	93

- 34 mm CCAW single layer voice coil combining light weight, stability at lower frequencies and total absence of musical transients compression.
- Extremely powerful custom N38 "H-grade" Neodymium magnet providing 1.67 T·m in the magnetic gap for superb dynamic response and very low distortion in the whole frequency range.
- Exclusive air-loading system resulting in a resonance frequency below 800 Hz, for filter set-up starting as low as 1.5 kHz - 12dB/Oct.
- 38 mm natural silk dome optimized with extensive material characterization, laser vibrometer scanning and Finite Element Analysis methods for a smooth and extended response.
- Frequency response up to 26 kHz optimized for off-axis installation.
- TH 1.5 II Violino Tuning System featuring two types of electro-acoustic load: bottom case or bottom disk according to targets of highest performance as well as flexibility of in-car integration.
- Full solid metal construction structure with each part exclusively designed and produced for the Audison TH 1.5 II.
- FEM (Finite Element Method) optimized faceplate and front spokes for an improved dispersion pattern.
- eID technology providing TH 1.5 II traceability starting from the manufacturing stage up to the owner.

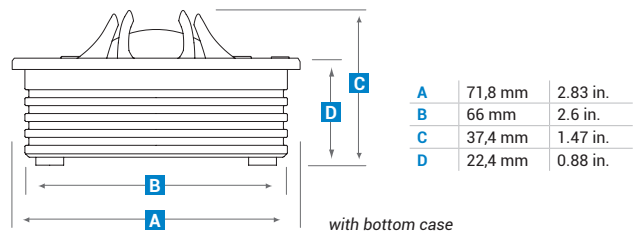

**Elettromedia**  
62018 Potenza Picena (MC) Italy  
T +39 0733 870 870 - F +39 0733 870 880  
elettromedia.com

audison



# TH 1.5 II Violino

200 W Max Power

## TH 1.5.II Violino - Bottom case

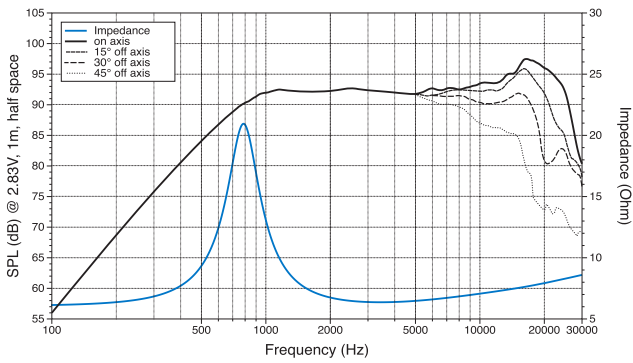

## TH 1.5.II Violino - Bottom disc

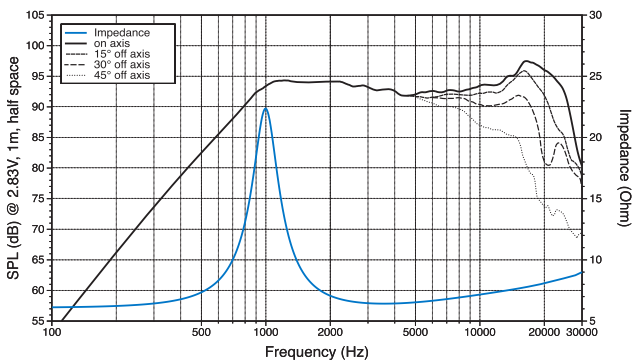

## TH 1.5.II Violino - Bottom case vs Bottom disc

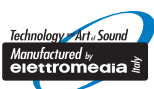
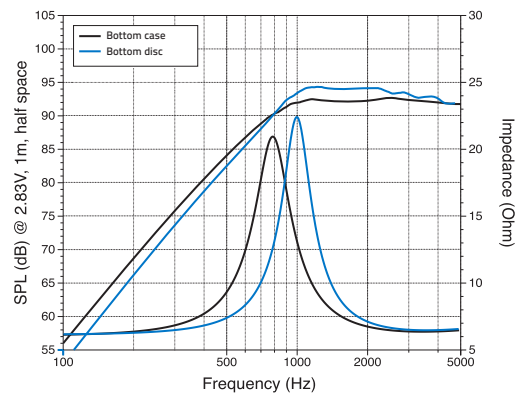

**Elettromedia**  
62018 Potenza Picena (MC) Italy  
T +39 0733 870 870 - F +39 0733 870 880  
elettromedia.com





# TH 3.0 II Voce

110 W Max Power



TECHNICAL SPECIFICATIONS		
Component		Woofers
Size	mm (in.)	70 (3)
Power Handling	W peak	110
	W continuous	55
Impedance	Ω	4
Frequency Response	Hz	110 ÷ 5700
Magnet size D x d x h	mm (in.)	29 x 6 x 8 (1.14 x 0.24 x 0.31)
Weight of one speaker	kg (lb.)	0,25 (0.55)
Voice Coil Ø	mm (in.)	30,5 (1.2)

ELECTRO-ACOUSTIC PARAMETERS		
D	mm	66,75
Xmax	mm	3,3
Re	Ω	3,4
Fs	Hz	100
Le	mH	0,18
Vas	l	1,01
Mms	g	4,3
Cms	mm/N	0,59
BL	T·m	4,2
Qts		0,48
Qes		0,52
Qms		5,5
Spl	dB/1W/1m	85,6

- 30,5 mm mobile voice coil in CCAR (Copper Clad Aluminum Ribbon) wound with flat wire to maximize the force factor and heat dissipation.
- Aluminium demodulation ring which linearizes the high excursion intermodulation distortion, canceling any sound colorations.
- N38 "H-grade neodymium magnet included in the voice coil to obtain superior control of the mobile crew and superior thermal stability.
- Motor geometry designed using finite element simulation software to optimize efficiency by concentrating the magnetic field in the gap.
- Membrane made of TPX®, a transparent material that reduces frequency response irregularities and provides a view of the inside of the speaker.
- Membrane geometry designed by simulation software to obtain homogeneous directivity.
- Optimized cone/surround break-up with extensive simulations to linearize the response at medium frequencies.
- Basket made of a single piece of die-cast aluminium with four pairs of spokes for maximum rigidity without slowing down the air flow.
- Suspension and spider with very high excursion, optimized with simulations of the multi-physical behavior of the speaker.
- eID technology for the traceability of TH 3.0 II Item from production to purchase.

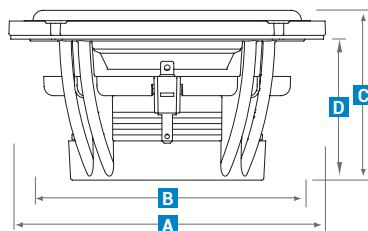
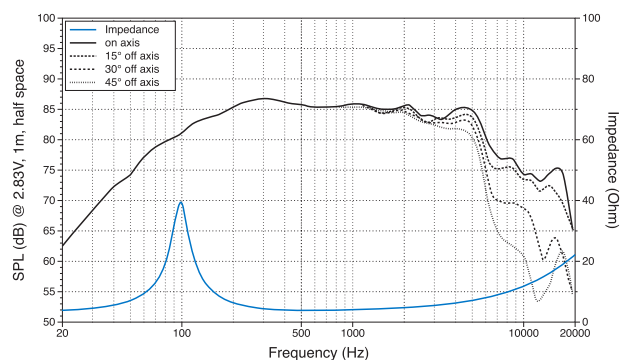

A	84 mm	3.31 in.
B	73,5 mm	2.89 in.
C	45 mm	1.77 in.
D	37 mm	1.46 in.
E	89 mm	3.5 in.
F	18 mm	0.71 in.

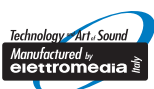
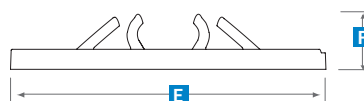

Elettromedia  
62018 Potenza Picena (MC) Italy  
T +39 0733 870 870 - F +39 0733 870 880  
elettromedia.com

audison





# TH 6.5 II Sax

300 W Max Power



TECHNICAL SPECIFICATIONS		
Component		Woofers
Size	mm (in.)	165 (6.5)
Power Handling	W peak	300
	W continuous	150
Impedance	Ω	4
Frequency Response	Hz	40 ÷ 4500
Magnet size D x d x h	mm (in.)	80 x 54 x 4,5 (3.15 x 2.13 x 0.18)
Weight of one speaker	kg (lb.)	1,25 (2.76)
Voice Coil Ø	mm (in.)	50 (2)

ELECTRO-ACOUSTIC PARAMETERS		
D	mm	130
Xmax	mm	5,4
Re	Ω	3,8
Fs	Hz	55
Le	mH	0,43
Vas	l	8,6
Mms	g	24,2
Cms	mm/N	0,35
BL	T·m	8,2
Qts		0,43
Qes		0,47
Qms		5,3
Spl	dB	87

- 50 mm mobile voice coil in CCAR (Copper Clad Aluminum Ribbon) wound with flat wire to maximize the force factor and heat dissipation.
- Low inductance of the mobile voice coil to optimize the emission in medium-high band (2-3 kHz).
- N48 "H-grade" neodymium magnet with superb thermal stability to guarantee an optimal dynamic reserve in every situation.
- Magnetic group geometry designed using finite element simulation software to maximize efficiency by concentrating the magnetic field in the gap.
- Membrane made of TPX®, a transparent material that reduces the frequency response irregularities in the mid-high band, leaving the speaker interior in full view.
- Membrane geometry designed using simulation software, to obtain a smooth emission over all the listening angles.
- Basket made of a single piece of die-cast aluminium featuring four pairs of spokes to optimize heat transfer, nullify turbulent airflows and ensure maximum structural rigidity.
- Hi-excursion suspension and spider, optimized with simulations of the loudspeaker multi-physical behavior.
- eID technology providing TH 6.5 II traceability starting from the manufacturing stage up to the owner.

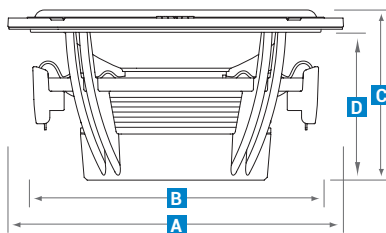
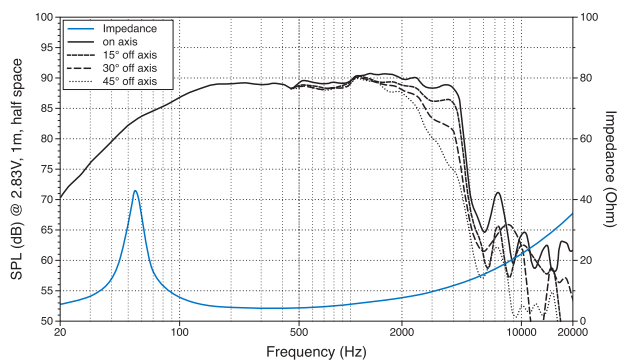

A	165 mm	6.5 in.
B	143 mm	5.63 in.
C	84 mm	3.31 in.
D	74,5 mm	2.93 in.
E	170,5 mm	6.71 in.
F	30 mm	1.18 in.

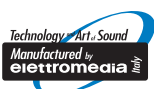
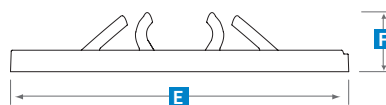

**Elettromedia**  
62018 Potenza Picena (MC) Italy  
T +39 0733 870 870 - F +39 0733 870 880  
elettromedia.com





# THX 2 II

300 W Max Power



TECHNICAL SPECIFICATIONS		
Component	2-way passive crossover	
Size	mm (in.)	348x190x66,5 (13.7x7.48x2.62)
Power Handling	W peak	300
	W continuous	150
Filters	Woofer cut-off	Lo-pass 1,35kHz @ 6 dB/Oct.
	Tweeter cut-off	Hi-pass 2.8 kHz @ 12 dB/Oct. Q=0,48
Filters -Adjustment	Contour @1 KHz	-3/-1,5/0 dB
	Tweeter level	-4/-2/0/+1,5 dB
Weight of one component	kg (lb)	3,6 (7)

1. Construction without compromise with the use of high quality resistors, capacitors and inductors.
2. Use of compensation networks for both woofer and tweeter, which optimize the load seen by the amplifier.
3. Best Envelopment filtering configuration with a well-distributed vertical scene along the entire height of the passenger compartment.
4. 4 emission levels for the tweeter (-4, -2, 0, +1,5 dB), designed using L-Pad technique.
5. Mid-frequency level control (-3, -1,5, 0 dB) centered at 900 Hz.
6. Possibility of bi-amplification.

A	348 mm	13.7 in.
B	324 mm	12.7 in.
C	66,5 mm	2.68 in.
D	190 mm	7.48 in.
E	166 mm	6.5 in.

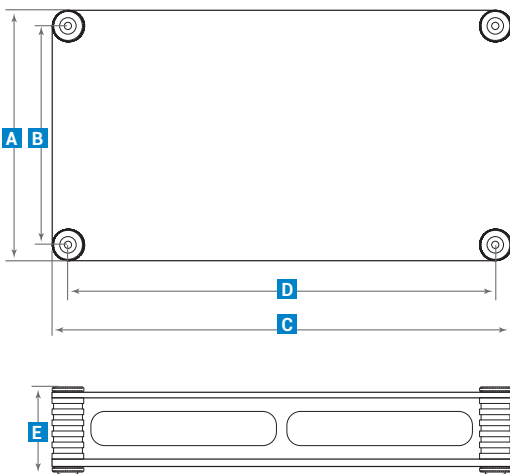

### TWEETER LEVEL ADJUSTMENT

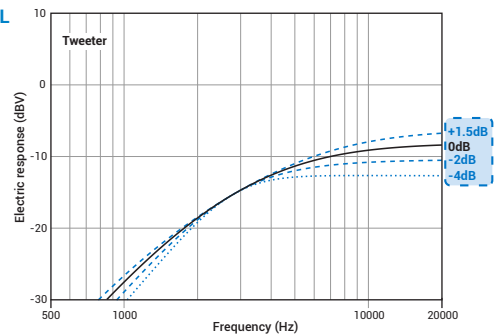

### MID CONTOUR ADJUSTMENT

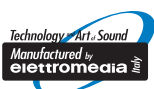
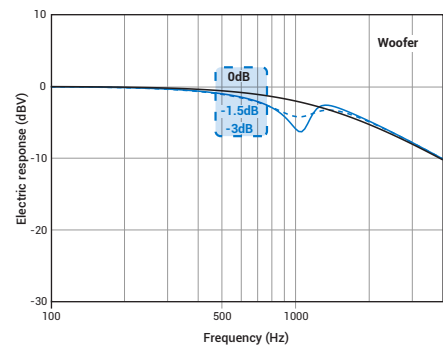

Elettromedia  
62018 Potenza Picena (MC) Italy  
T +39 0733 870 870 - F +39 0733 870 880  
elettromedia.com





# TH K2 II A Coro

## 300 W Max Power



TECHNICAL SPECIFICATIONS		
Component	2-way system	
Size		
Woofer	mm (in.)	165 (6.5)
Tweeter diaphragm	mm (in.)	38 (1.5)
Voice Coil Ø		
Woofer	mm (in.)	50 (2)
Tweeter	mm (in.)	34 (1.34)
Power Handling	W peak	300
	W continuous	150
Sensitivity	dB SPL	87
Impedance	Ω	4
Frequency Response	Hz	40 ÷ 26k
SUGGESTED ACTIVE FILTERING: Best Envelopment <small>This set-up provides the best sound stage envelopment for listeners who prefer vertical stage well distributed along the full cabin height.</small>	Woofer	Lo-pass 2.5 kHz @ 6 dB/Oct. Butterworth, level 0 dB
	Tweeter	Hi-pass 2.75 kHz @ 12 dB/Oct. Butterworth, level -6 dB ÷ -8 dB
SUGGESTED ACTIVE FILTERING: Best Focus <small>This set-up provides the best sound stage focus for listeners who prefer vertical stage well focused above of the dashboard and a wider horizontal stage.</small>	Woofer	Lo-pass 1.25 kHz @ 12 dB/Oct. Linkwitz, level 0 dB
	Tweeter	Hi-pass 1.25 kHz @ 12 dB/Oct. Linkwitz, level -7 dB ÷ -9 dB
Weight of one component		
Woofer	kg (lb)	1.25 (2.76)
Tweeter	kg (lb)	0,355 (0.78)

ELECTRO-ACOUSTIC PARAMETERS		TH 1.5 II Violino		
		TH 6.5 II Sax	Bottom Case	Bottom Disk
D	mm	130	38	38
Xmax	mm	5,4	-	-
Re	Ω	3,8	6,1	6,1
Fs	Hz	55	780	980
Le	mH	0,43	0,025	0,025
Vas	l	8,6	0,019	0,013
Mms	g	24,2	0,43	0,43
Cms	mm/N	0,35	0,09	0,062
BL	T·m	8,2	3,32	3,44
Qts		0,43	0,83	0,97
Qes		0,47	1,2	1,3
Qms		5,3	2,9	3,5
Spl	dB	87	92,5	93

### TH 1.5 II Violino

- 34 mm CCAW single layer voice coil combining light weight, stability at lower frequencies and total absence of musical transients compression.
- Extremely powerful custom N38 "H-grade" Neodymium magnet providing 1.67 T·m in the magnetic gap for superb dynamic response and very low distortion in the whole frequency range.
- Exclusive air-loading system resulting in a resonance frequency below 800 Hz, for filter set-up starting as low as 1.5 kHz - 12dB/Oct.
- 38 mm natural silk dome optimized with extensive material characterization, laser vibrometer scanning and Finite Element Analysis methods for a smooth and extended response.
- Frequency response up to 26 kHz optimized for off-axis installation.
- TH 1.5 II Violino Tuning System featuring two types of electro-acoustic load: bottom case or bottom disk according to targets of highest performance as well as flexibility of in-car integration.
- Full solid metal construction structure with each part exclusively designed and produced for the Audison TH 1.5 II.
- FEM (Finite Element Method) optimized faceplate and front spokes for an improved dispersion pattern.
- eID technology providing TH 1.5 II traceability starting from the manufacturing stage up to the owner.

### TH 6.5 II Sax

- 50 mm mobile voice coil in CCAR (Copper Clad Aluminum Ribbon) wound with flat wire to maximize the force factor and heat dissipation.
- Low inductance of the mobile voice coil to optimize the emission in medium-high band (2-3 kHz).
- N48 "H-grade" neodymium magnet with superb thermal stability to guarantee an optimal dynamic reserve in every situation.
- Magnetic group geometry designed using finite element simulation software to maximize efficiency by concentrating the magnetic field in the gap.
- Membrane made of TPX®, a transparent material that reduces the frequency response irregularities in the mid-high band, leaving the speaker interior in full view.
- Membrane geometry designed using simulation software, to obtain a smooth emission over all the listening angles.
- Basket made of a single piece of die-cast aluminium featuring four pairs of spokes to optimize heat transfer, nullify turbulent airflows and ensure maximum structural rigidity.
- Hi-exursion suspension and spider, optimized with simulations of the loudspeaker multi-physical behavior.
- eID technology providing TH 6.5 II traceability starting from the manufacturing stage up to the owner.





# TH K2 II A Coro

300 W Max Power

## SUGGESTED ACTIVE FILTERING: Best Envelopment

TH K2 II CORO A - TH 6.5 II Sax + TH 1.5 II Violino Active

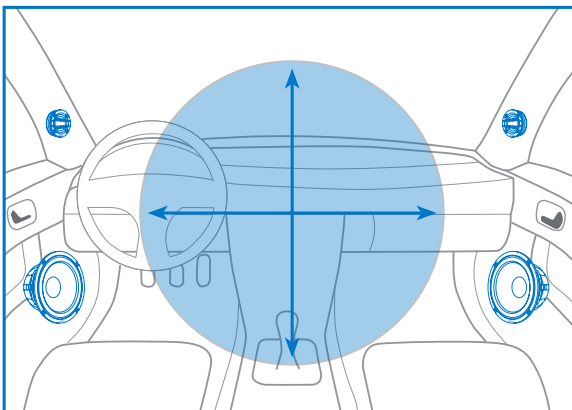

### Best Envelopment

This set-up provides the best sound stage envelopment for listeners who prefer vertical stage well distributed along the full cabin height.

Tweeter Setup

Hi-pass 2.75 kHz @ 12 dB/Oct.  
Butterworth, level -6 dB ÷ -8 dB

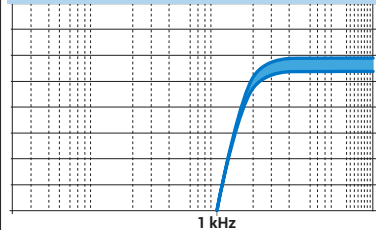

-6 dB  
-8 dB



Woofer Setup

Lo-pass 2.5 kHz @ 6 dB/Oct.  
Butterworth, level 0 dB

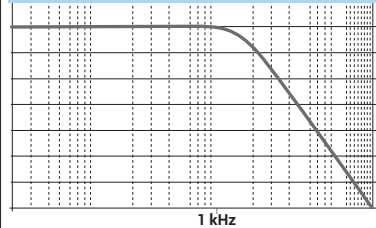

+  
-

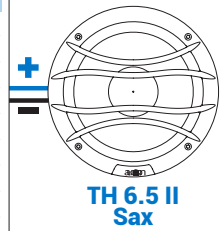

System Setup

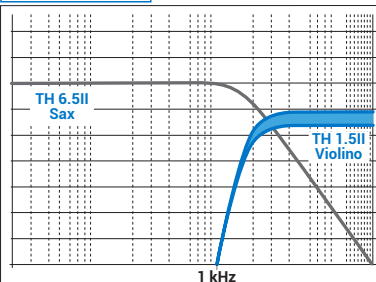

-6 dB  
-8 dB



# TH K2 II A Coro

300 W Max Power

## SUGGESTED ACTIVE FILTERING: Best Focus

TH K2 II CORO A - TH 6.5 II Sax + TH 1.5 II Violino Active

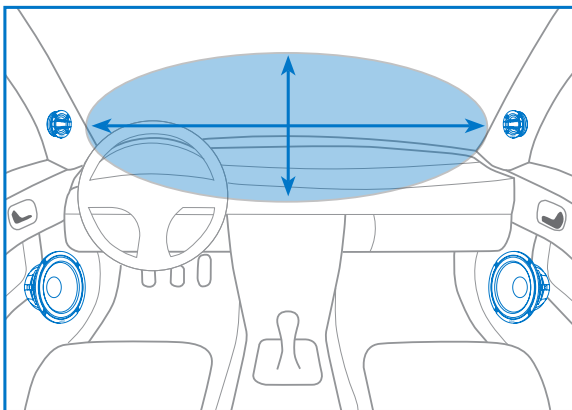

### Best Focus

This set-up provides the best sound stage focus for listeners who prefer vertical stage well focused above of the dashboard and a wider horizontal stage.

### Tweeter Setup

Hi-pass 1.25 kHz @ 12 dB/Oct.  
Linkwitz, level -7 dB ÷ -9 dB

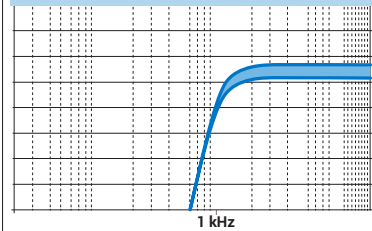

-7 dB  
-9 dB



TH 1.5 II Violino

### Woofers Setup

Lo-pass 1.25 kHz @ 12 dB/Oct.  
Linkwitz, level 0 dB

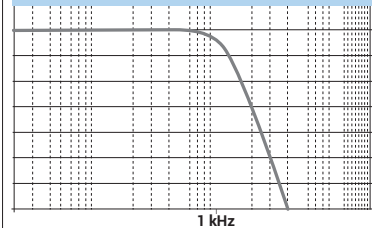

+  
-

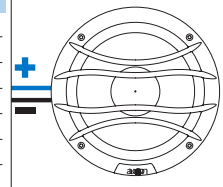

TH 6.5 II Sax

### System Setup

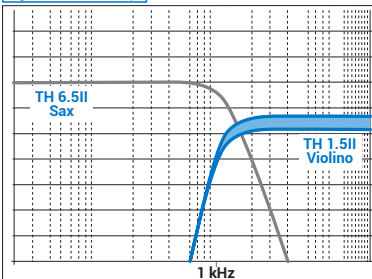

-7 dB  
-9 dB



## TH K2 II P Coro

300 W Max Power



TECHNICAL SPECIFICATIONS		
Component	2-way system	
Size		
Woofer	mm (in.)	165 (6.5)
Tweeter diaphragm	mm (in.)	38 (1.5)
Crossover	mm (in.)	348x190x66,5 (13.7x7.48x2.62)
Voice Coil Ø		
Woofer	mm (in.)	50 (2)
Tweeter	mm (in.)	34 (1.34)
Power Handling	W peak	300
	W continuous	150
Sensitivity	dB SPL	87
Impedance	Ω	4
Frequency Response	Hz	40 ÷ 26k
Crossover	Woofer cut-off	Lo-pass 1,35kHz @ 6 dB/Oct.
	Tweeter cut-off	Hi-pass 2.8 kHz @ 12 dB/Oct. Q=0,48
Crossover -Adjustment	Contour @1 KHz	-3/-1,5/0 dB
	Tweeter level	-4/-2/0/+1,5 dB
Weight of one component		
Woofer	kg (lb)	1.25 (2.76)
Tweeter	kg (lb)	0,335 (0.78)
Crossover	kg (lb)	3,6 (7)

ELECTRO-ACOUSTIC PARAMETERS		TH 6.5 II Sax	TH 1.5 II Violino	
			Bottom Case	Bottom Disk
D	mm	130	38	38
Xmax	mm	5,4	-	-
Re	Ω	3,8	6,1	6,1
Fs	Hz	55	780	980
Le	mH	0,43	0,025	0,025
Vas	l	8,6	0,019	0,013
Mms	g	24,2	0,43	0,43
Cms	mm/N	0,35	0,09	0,062
BL	T·m	8,2	3,32	3,44
Qts		0,43	0,83	0,97
Qes		0,47	1,2	1,3
Qms		5,3	2,9	3,5
Spl	dB	87	92,5	93

### TH 1.5 II Violino

- 34 mm CCAW single layer voice coil combining light weight, stability at lower frequencies and total absence of musical transients compression.
- Extremely powerful custom N38 "H-grade" Neodymium magnet providing 1.67 T·m in the magnetic gap for superb dynamic response and very low distortion in the whole frequency range.
- Exclusive air-loading system resulting in a resonance frequency below 800 Hz, for filter set-up starting as low as 1.5 kHz - 12dB/Oct.
- 38 mm natural silk dome optimized with extensive material characterization, laser vibrometer scanning and Finite Element Analysis methods for a smooth and extended response.
- Frequency response up to 26 kHz optimized for off-axis installation.
- TH 1.5 II Violino Tuning System featuring two types of electro-acoustic load: bottom case or bottom disk according to targets of highest performance as well as flexibility of in-car integration.
- Full solid metal construction structure with each part exclusively designed and produced for the Audison TH 1.5 II.
- FEM (Finite Element Method) optimized faceplate and front spokes for an improved dispersion pattern.
- eID technology providing TH 1.5 II traceability starting from the manufacturing stage up to the owner.

### TH 6.5 II Sax

- 50 mm mobile voice coil in CCAR (Copper Clad Aluminum Ribbon) wound with flat wire to maximize the force factor and heat dissipation.
- Low inductance of the mobile voice coil to optimize the emission in medium-high band (2-3 kHz).
- N48 "H-grade" neodymium magnet with superb thermal stability to guarantee an optimal dynamic reserve in every situation.
- Magnetic group geometry designed using finite element simulation software to maximize efficiency by concentrating the magnetic field in the gap.
- Membrane made of TPX®, a transparent material that reduces the frequency response irregularities in the mid-high band, leaving the speaker interior in full view.
- Membrane geometry designed using simulation software, to obtain a smooth emission over all the listening angles.
- Basket made of a single piece of die-cast aluminium featuring four pairs of spokes to optimize heat transfer, nullify turbulent airflows and ensure maximum structural rigidity.
- Hi-exursion suspension and spider, optimized with simulations of the loudspeaker multi-physical behavior.
- eID technology providing TH 6.5 II traceability starting from the manufacturing stage up to the owner.

### THX 2 II

- Construction without compromise with the use of high quality resistors, capacitors and inductors.
- Use of compensation networks for both woofer and tweeter, which optimize the load seen by the amplifier.
- Best Envelopment filtering configuration with a well-distributed vertical scene along the entire height of the passenger compartment.
- 4 emission levels for the tweeter (-4, -2, 0, +1,5 dB), designed using L-Pad technique.
- Mid-frequency level control (-3 -> 0 dB) centered at 900 Hz.
- Possibility of bi-amplification.



# TH K3 II A Orchestra

350 W Max Power



TECHNICAL SPECIFICATIONS		
Component	3-way system	
Size		
Woofer	mm (in.)	165 (6.5)
Midrange	mm (in.)	70 (3)
Tweeter diaphragm	mm (in.)	38 (1.5)
Voice Coil Ø		
Woofer	mm (in.)	50 (2)
Midrange	mm (in.)	30,5 (1.2)
Tweeter	mm (in.)	34 (1.34)
Power Handling	W peak	350
	W continuous	200
Sensitivity	dB SPL	87,5
Impedance	Ω	4
Frequency Response	Hz	40 ÷ 26k
SUGGESTED ACTIVE FILTERING: system delivers maximum performance in active multi-amplification by exploiting the linear phase crossover FIR filters available in the two flagship processors, bit One HD and bit One HD Virtuoso.	Woofer	LoPass 250 ÷ 400 Hz @ 24 or 48 dB/Oct. Level: 0 dB
	Midrange	HiPass 250 ÷ 400 Hz @ 12dB/Oct. LoPass 3k ÷ 4kHz @ 12dB/Oct. Level: 0 ÷ -1 dB
	Tweeter	HiPass 4kHz @ 12dB/Oct Level: -5 ÷ -7 dB
Weight of one component		
Woofer	kg (lb)	1.25 (2.76)
Midrange	kg (lb)	0,25 (0.55)
Tweeter	kg (lb)	0,355 (0.78)

ELECTRO-ACOUSTIC PARAMETERS		TH 6.5 II	TH 3.0 II	TH 1.5 II Violino	
		Sax	Voce	Bott. Case	Bott. Disk
D	mm	130	66,75	38	38
Xmax	mm	5,4	3,3	-	-
Re	Ω	3,8	3,4	6,1	6,1
Fs	Hz	55	100	780	980
Le	mH	0,43	0,18	0,025	0,025
Vas	l	8,6	1,01	0,019	0,013
Mms	g	24,2	4,3	0,43	0,43
Cms	mm/N	0,35	0,59	0,09	0,062
BL	T·m	8,2	4,2	3,32	3,44
Qts		0,43	0,48	0,83	0,97
Qes		0,47	0,52	1,2	1,3
Qms		5,3	5,5	2,9	3,5
Spl	dB	87	85,6	92,5	93

### TH 1.5 II Violino

- 34 mm CCAW single layer voice coil combining light weight, stability at lower frequencies and total absence of musical transients compression.
- Extremely powerful custom N38 "H-grade" Neodymium magnet providing 1.67 T·m in the magnetic gap for superb dynamic response and very low distortion in the whole frequency range.
- Exclusive air-loading system resulting in a resonance frequency below 800 Hz, for filter set-up starting as low as 1.5 kHz - 12dB/Oct.
- 38 mm natural silk dome optimized with extensive material characterization, laser vibrometer scanning and Finite Element Analysis methods for a smooth and extended response.
- Frequency response up to 26 kHz optimized for off-axis installation.
- TH 1.5 II Violino Tuning System featuring two types of electro-acoustic load: bottom case or bottom disk according to targets of highest performance as well as flexibility of in-car integration.
- Full solid metal construction structure with each part exclusively designed and produced for the Audison TH 1.5 II.
- FEM (Finite Element Method) optimized faceplate and front spokes for an improved dispersion pattern.
- eID technology providing TH 1.5 II traceability starting from the manufacturing stage up to the owner.

### TH 3.0 II Voce

- 30,5 mm mobile voice coil in CCAR (Copper Clad Aluminum Ribbon) wound with flat wire to maximize the force factor and heat dissipation.
- Aluminium demodulation ring which linearizes the high excursion intermodulation distortion, canceling any sound colorations.
- N38 "H-grade" neodymium magnet included in the voice coil to obtain superior control of the mobile crew and superior thermal stability.
- Motor geometry designed using finite element simulation software to optimize efficiency by concentrating the magnetic field in the gap.
- Membrane made of TPX®, a transparent material that reduces frequency response irregularities and provides a view of the inside of the speaker.
- Membrane geometry designed by simulation software to obtain homogeneous directivity.
- Optimized cone/surround break-up with extensive simulations to linearize the response at medium frequencies.
- Basket made of a single piece of die-cast aluminium with four pairs of spokes for maximum rigidity without slowing down the air flow.
- Suspension and spider with very high excursion, optimized with simulations of the multi-physical behavior of the speaker.
- eID technology for the traceability of TH 3.0 II Item from production to purchase.

### TH 6.5 II Sax

- 50 mm mobile voice coil in CCAR (Copper Clad Aluminum Ribbon) wound with flat wire to maximize the force factor and heat dissipation.
- Low inductance of the mobile voice coil to optimize the emission in medium-high band (2-3 kHz).
- N48 "H-grade" neodymium magnet with superb thermal stability to guarantee an optimal dynamic reserve in every situation.
- Magnetic group geometry designed using finite element simulation software to maximize efficiency by concentrating the magnetic field in the gap.
- Membrane made of TPX®, a transparent material that reduces the frequency response irregularities in the mid-high band, leaving the speaker interior in full view.
- Membrane geometry designed using simulation software, to obtain a smooth emission over all the listening angles.
- Basket made of a single piece of die-cast aluminium featuring four pairs of spokes to optimize heat transfer, nullify turbulent airflows and ensure maximum structural rigidity.
- Hi-excursion suspension and spider, optimized with simulations of the loudspeaker multi-physical behavior.
- eID technology providing TH 6.5 II traceability starting from the manufacturing stage up to the owner.



# TH K3 II A Orchestra

350 W Max Power

## SUGGESTED FILTER OPTIONS

TH K3 II A ORCHESTRA system delivers maximum performance in active multi-amplification by exploiting the linear phase crossover FIR filters available in the two flagship processors, bit One HD and bit One HD Virtuoso.

### Tweeter Setup

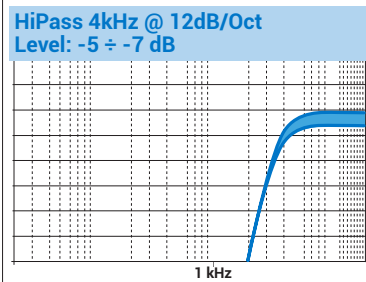

**ATTENTION:** Tweeter phase must be reversed by DSP setting for this set-up.

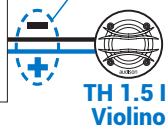

### Midrange Setup

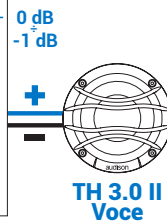
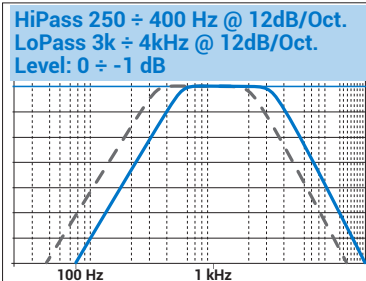

### Woofers Setup

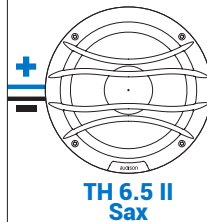
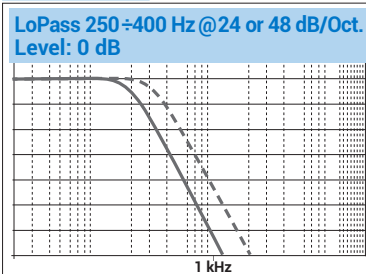

All specifications subject to change without notice\_20.A





elettromedia

Elettromedia, an Italian company, is a leader within the world-wide car Hi-Fi market. Born in 1987 in Potenza Picena by a group of friends who shared the same passion for in-car high fidelity, throughout the past years Elettromedia has been walking the path of excellence: its products are distributed in more than 50 countries; the company has received many awards and acknowledgements from the most authoritative leaders within the car audio industry; it also can boast reviews of more than 3000 pages published in 30 different languages (visit: <https://www.elettromedia.com/media-centre/press-review/>).

The Elettromedia brands are Audison, Hertz and Connection. Through a co-branding strategy, the company offers all of the components required for a complete, top-level car audio system. Since 2008, Elettromedia has a joint venture with Lavoce Italiana a company specialized in loudspeaker design and production for the professional audio industry.



Elettromedia  
web site

**Contacts: Elettromedia s.r.l.**  
**Strada Regina km 3,500 - 62018 Potenza Picena (Mc) - Italy**  
**T +39 0733 870 870 - F +39 0733 870 880 - [elettromedia.com](http://elettromedia.com)**

**AWARDS**



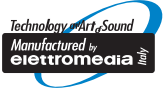

All specifications subject to change without notice

[www.audison.eu](http://www.audison.eu)

**audison**  
ISTINTO  
INNOVATIVO

**PART OF ELETTROMEDIA**  
62018 Potenza Picena (MC) Italy  
T +39 0733 870 870 - F +39 0733 870 880  
[www.elettromedia.it](http://www.elettromedia.it)