

**v.LOGiC Intelligent Solution
Interface**

V5-CIC-F-PNP

**Compatible with the F-series BMW with
navigation system or radio and 7" or 10.2"
monitor with 4pin HSD
LVDS connector**

Product features

- Own on-screen display and setup
- Rear-view camera input
- Automatic switching to rear-view camera input on engagement of reverse gear from all operation modes
- Front camera input / SMART-LINK input
- Control of SMART-LINK module over iDrive control panel
- Manual switching to rear-view camera (only for vehicles with PDC button)
- Manual return from rear-view and front camera (cancellation of automatic switching)
- 2 trigger outputs (+12V max. 1A), separately adjustable switching events (CAN, ACC, camera, reverse gear)
- Picture-in-picture mode combining after-market rear-view and front camera picture(s) with factory parking sensor graphics
- Compatible with all factory video accessories (e.g. rear-view camera, Top-View, nightvision, DVD-changer, TV-tuner)
- USB update-port for software-updates by consumer

Contents

1. Prior to Installation

- 1.1. Delivery contents
- 1.2. Check compatibility of vehicle and accessories
- 1.3. Setting the dip switches of the interface-box V5C-M636
- 1.4. LED's of the interface-box V5C-M636

2. Connection schema

3. Installation

- 3.1. Connecting interface-box and harnesses
- 3.2. LVDS connection
- 3.3. Connection to the iDrive
 - 3.3.1. After-market front camera
 - 3.3.1.1. Connection to the after-market front camera
 - 3.3.1.2. Settings for connecting an after-market front camera
 - 3.3.2. After-market rear-view camera
 - 3.3.2.1. Connection to the after-market rear-view camera
 - 3.3.2.2. Settings for connecting an after-market rear-view camera
 - 3.3.2.3. Settings for OEM rear-view camera
 - 3.3.3. SMART-LINK
 - 3.3.3.1. SMART-LINK video and control connection
 - 3.3.3.2. SMART-LINK audio connection
 - 3.3.3.3. Settings for SMART-LINK connecting
 - 3.3.4. Configurable trigger outputs
- 3.4. Picture settings
- 3.5. Picture format settings

4. Operation

- 4.1. OSD – On-screen display
 - 4.1.1. OSD – Operation
 - 4.1.1.1. 8-button iDrive
 - 4.1.1.2. 2-button iDrive in Mini
 - 4.1.2. OSD – Additional setting options
- 4.2. Video-in-motion function
- 4.3. Selecting the interface as current video-source
- 4.4. Controlling of the connected SMART-LINK module

5. Specifications

6. Connections (interface-box)

7. Technical support

Legal Information

By law, watching moving pictures while driving is prohibited, the driver must not be distracted. We do not accept any liability for material damage or personal injury resulting, directly or indirectly, from installation or operation of this product. This product should only be used while standing or to display fixed menus or rear-view-camera video when the vehicle is moving, for example the MP3 menu for DVD upgrades.

Changes/updates of the vehicle's software can cause malfunctions of the interface. We offer free software-updates for our interfaces for one year after purchase. To receive a free update, the interface must be sent in at own cost. Labor cost for and other expenses involved with the software-updates will not be refunded.

1. Prior to installation

Read the manual prior to installation. Technical knowledge is necessary for installation. The place of installation must be free of moisture and away from heat sources.

1.1. Delivery contents

Take down the SW-version and HW-version of the interface boxes, and store this manual for support purposes.

Interface-box
V5C-M636
HW _____ SW _____



LVDS cable
CAB-HSD-MG060-OZ



V5C-UNI02
harness



LVDS cable
CAB-HSD-DD075-O



TV-BM01
harness

1.2. Check compatibility of vehicle and accessories

Requirements

Navigation

F-series with navigation system or radio with 7" or 10" monitor
(F-series) with 4pin HSD LVDS connector

1.3. Setting the dip switches of the interface-box V5C-M636

Dip 1 and 2 on the back of the interface-box V5C-M636 are used to set the monitor type. The default setting is:

Vehicle/ navigation	Dip 1	Dip 2	Dip 3
CIC-F (F-series), 7" monitor	ON	OFF	No function
CIC-F (F-series), 10" monitor	ON	ON	No function

After each change of the dip switch settings you have to execute a power reset of the interface-box!

1.4. LED's of the interface-box V5C-M636



2. Connection schema

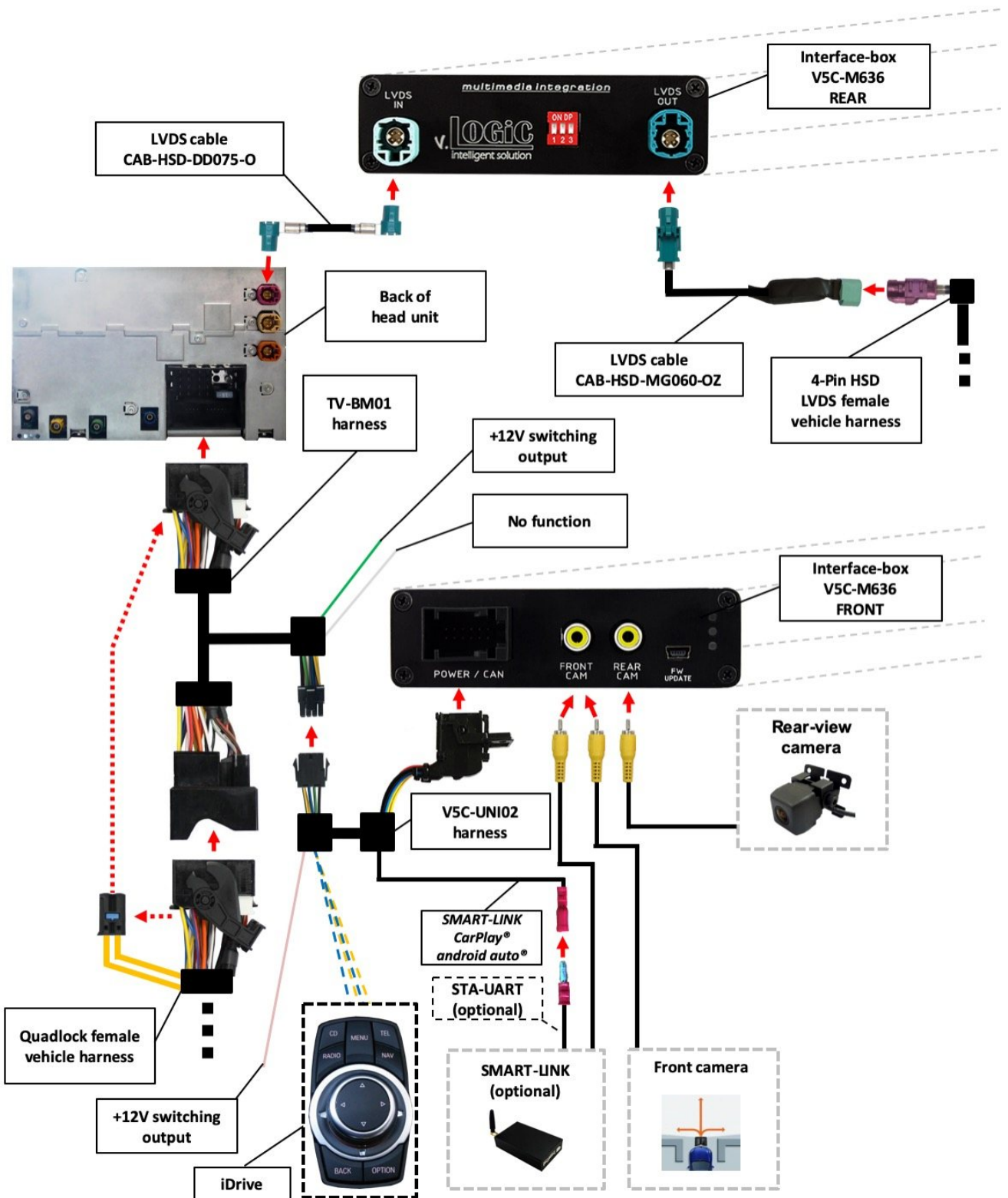

3. Installation

Switch off ignition and disconnect the vehicle's battery! The interface needs a permanent 12V source. If according to factory rules disconnecting the battery is to be avoided, it is usually sufficient to put the vehicle in sleep-mode. In case the sleep-mode does not show success, disconnect the battery with a resistor lead.

If power source is not taken directly from the battery, the connection has to be checked for being start-up proven and permanent.

Prior to wire and device installation we suggest to connect and test correct function of all after-market and factory infotainment equipment!

The interface is installed on the backside of the head unit.

3.1. Connecting interface-box and harnesses

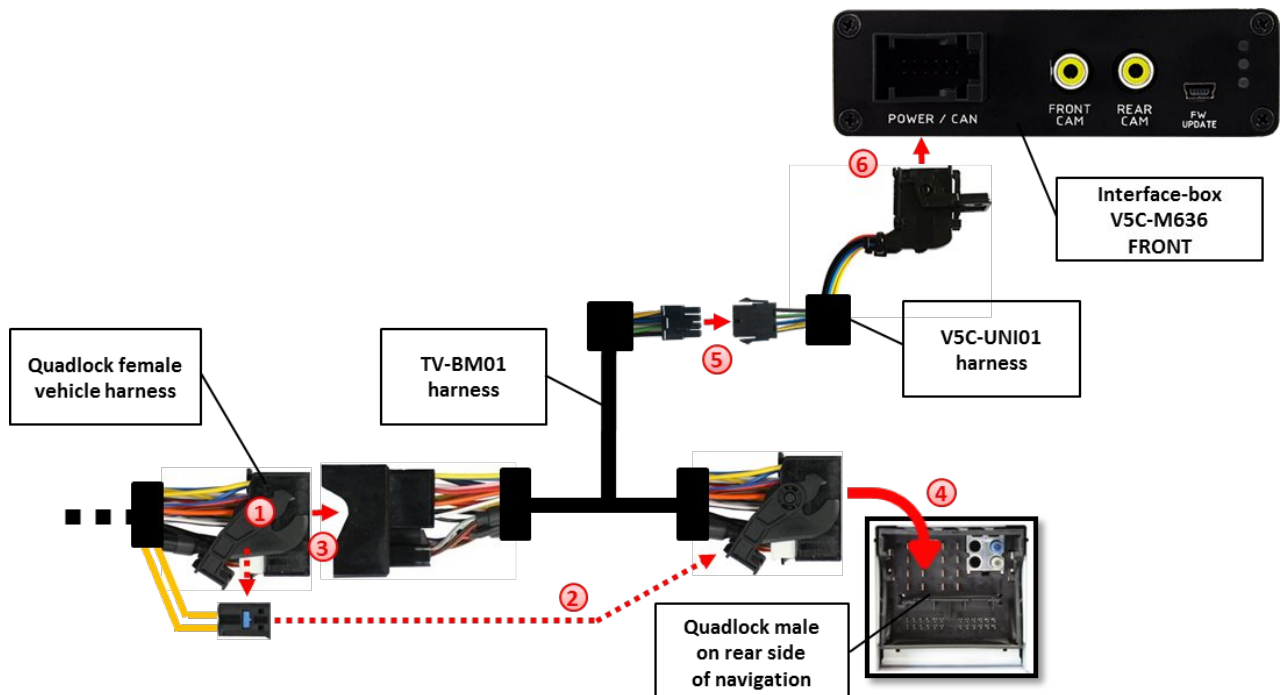

- 1 Remove the female Quadlock connector of the vehicle harness from the rear of the navigation computer.
- 2 Remove optical leads from the female Quadlock connector of the vehicle harness and insert them into the female Quadlock connector of harness TV-BM01 at the same position.
- 3 Connect female Quadlock connector of vehicle harness to the male Quadlock connector of harness TV-BM01.
- 4 Connect female Quadlock connector of harness TV-BM01 to the male Quadlock connector of the navigation computer.

- 5 Connect female 8 pin molex connector of the harness TV-BM01 to the male 8 pin molex connector of the harness TV-BM01.
- 6 Connect female 12pin AMP connector of the harness TV-BM01 to the front site of the V5C-M636 interface box.

3.2. LVDS connection

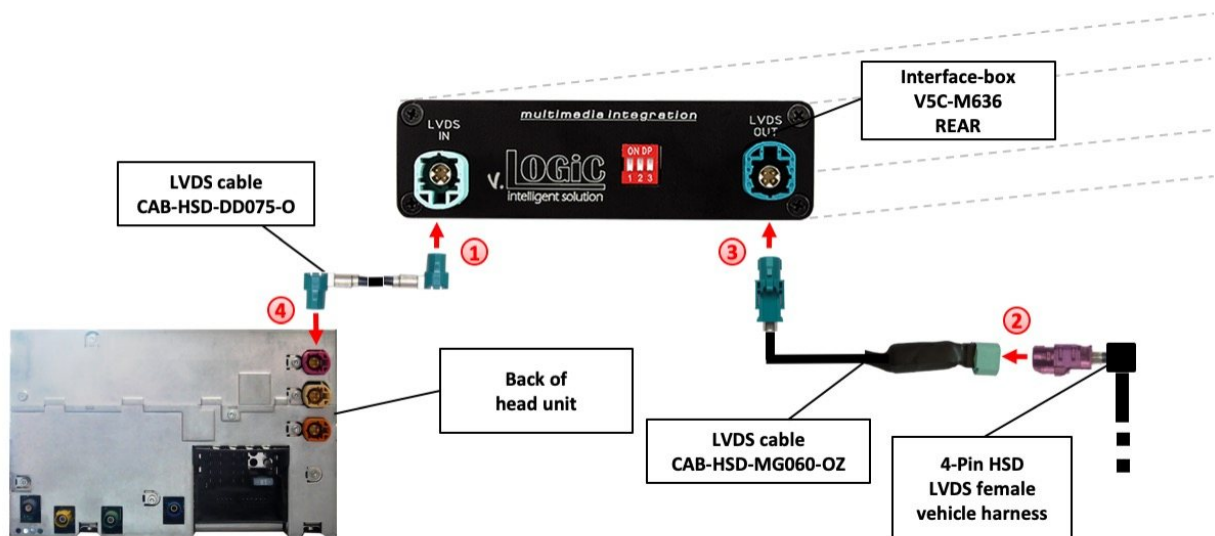

- 1 Connect the female 4pin HSD LVDS connector of the LVDS cable CAB-HSD-DD075-O to the male 4pin HSD LVDS connector (LVDS-IN) on the rear of the interface-box V5C-M636.
- 2 Remove the pink female 4pin HSD LVDS connector of the vehicle harness at the back of the head unit and connect it to the male 4pin HSD LVDS of the CAB-HSD-MG060-OZ LVDS cable.
- 3 Connect the female 4pin HSD LVDS connector of the LVDS cable CAB-HSD-MG060-OZ to the male 4pin HSD LVDS connector (LVDS-OUT) on the rear of the interface-box V5C-M636.
- 4 Connect the female 4pin HSD LVDS connector of the LVDS cable CAB-HSD-DD075-O to the pink male 4pin HSD LVDS connector on the rear of the head unit.

3.3. Connection to the iDrive

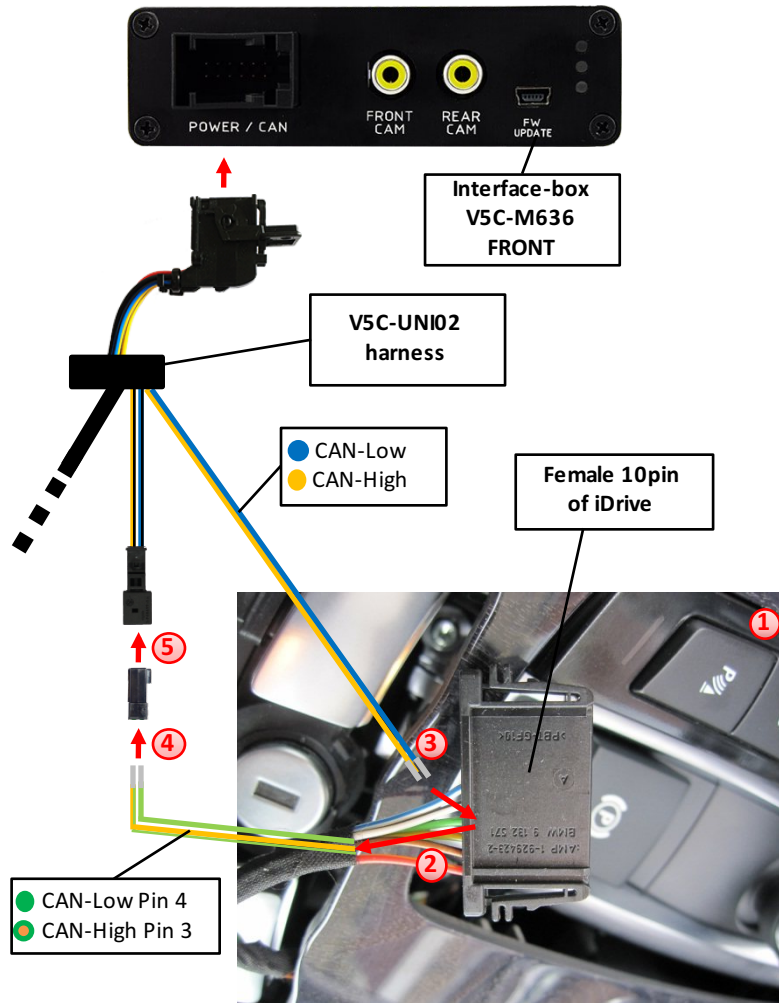

- 1 Remove the iDrive from the centre console and unplug the existing flat female 10pin or 4pin cable connector.
- 2 Remove pin 3 green/orange CAN-high and pin 4 green CAN-low of vehicle harness from the female cable connector.
- 3 Pin yellow (blue) pin of harness V5C-UNI02 into pin 3 CAN-high (pin 4 CAN-low) of the female cable connector.
- 4 Pin the green/orange cable CAN-high (green cable CAN-low) of the vehicle harness into pin 1 of the included female 2pin AMP connector.
- 5 Connect female 2pin AMP connector to 2pin AMP connector (yellow/black and blue/black cable) of harness V5C-UNI02.

3.3.1. After-market front camera

3.3.1.1. Connection to the after-market front camera

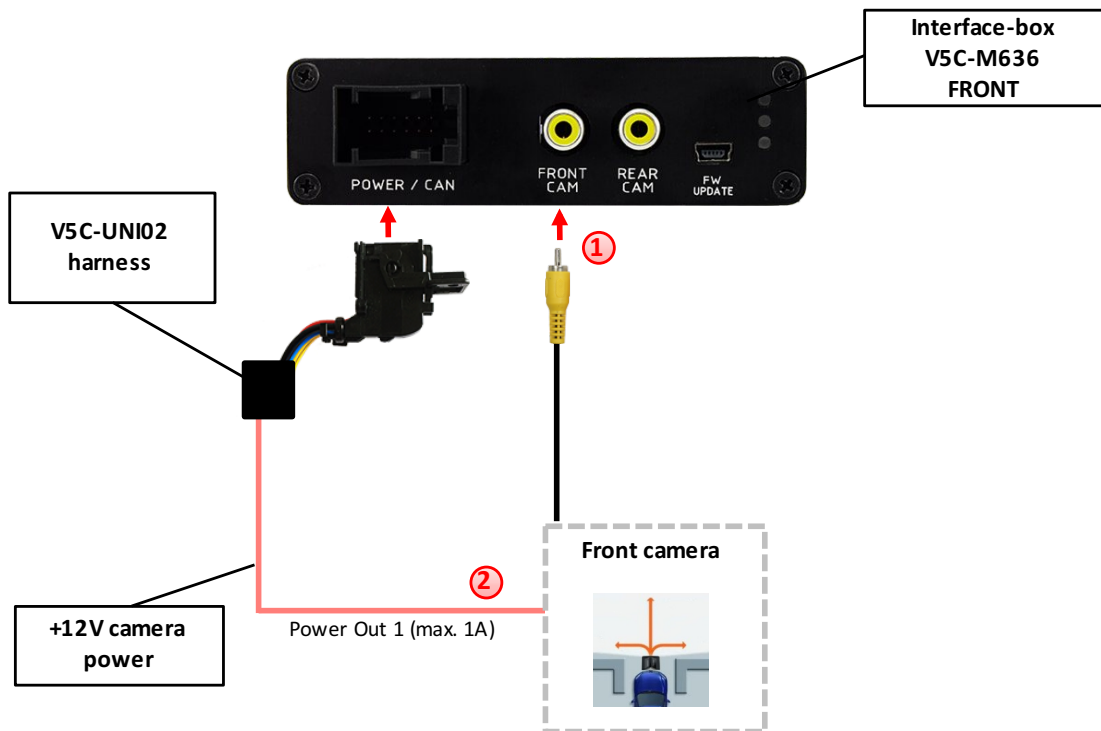

- 1 Connect the video RCA of the after-market front camera to the female RCA connector "FRONT CAM" of the interface box V5C-M636.
- 2 The pink wire of harness V5C-UNI02 can be used for +12V electric power supply (max. 1A) of the after-market front camera. Configure in the OSD-menu "MISC", menu item "POWER OUT 2" the designated electric power supply (see chapter "Configurable switching outputs").



3.3.1.2. Settings for connecting an after-market front camera

You have to configure some settings in the OSD-menus INPUTS and MISC if you want to connect an after-market front camera (Operation of the OSD: see chapter “OSD-Operation”).



OSD-menu	Menu item	Setting	Explication
INPUTS	FRONT CAM	OFF	No front camera connected
		ON	Switches to front camera if parking process is enabled and reverse gear is released
	ReverseLogic	Intelligent	For vehicles with PDC button. Enabled while parking process and up to 20 km/h or together with PDC if existing
		Gear only	For vehicles without PDC button. Enabled while parking process and up to 20 km/h.
MISC	OEM PDC CAR	Horizontal	PDC-display of the vehicle is horizontal
		Vertical	PDC-display of the vehicle is vertical

Note: You can deactivate the enabled parking process by pressing the iDrive or by enabling other modes (e.g. radio). After deactivation you can't enable the parking process again until the vehicle is diving faster than 20km/h, the ignition is switched off and on or the PDC will be disabled and enabled again, if existing.

3.3.2. After-market rear-view camera

3.3.2.1. Connection to the after-market rear-view camera

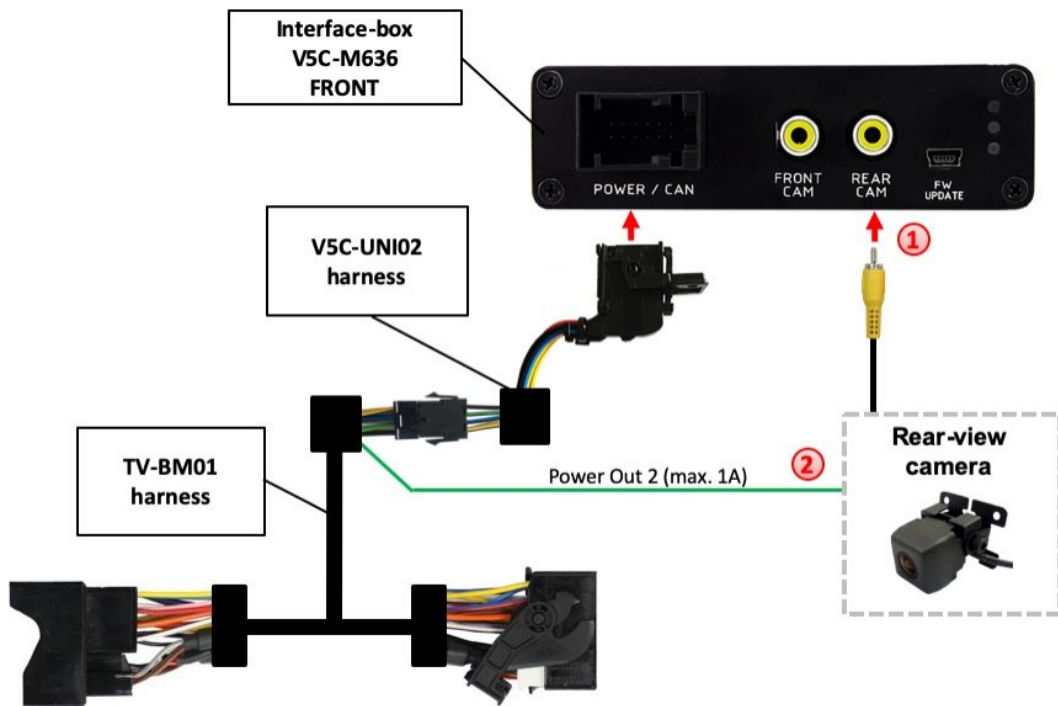

- 1 Connect the video RCA of the after-market rear-view camera to the female RCA connector "REAR CAM" of the interface box V5C-M636.
- 2 The green wire of harness TV-BM01 can be used for +12V electric power supply (max. 1A) of the after-market rear-view camera. Configure in the OSD-menu "MISC", menu item "POWER OUT 2" the designated electric power supply (see chapter "Configurable switching outputs").

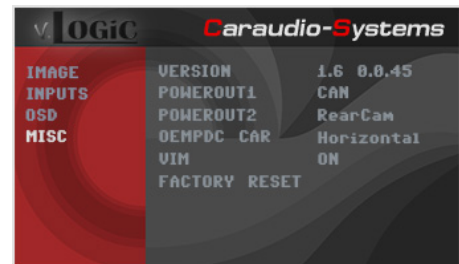

3.3.2.2. Settings for connecting an after-market rear-view camera

You have to configure some settings in the OSD-menus INPUTS and MISC if you want to connect an after-market rear-view camera (Operation of the OSD: see chapter “OSD-Operation”).



OSD-menu	Menu item	Setting	Explication
INPUTS	REAR CAM	OFF	No rear-view camera connected
		ON	Switches to rear-view camera if reverse gear is engaged and/or PDC-display is displayed
		OEM	If a factory rear-view camera is existing! Interface turns off, if PDC or reverse gear is enabled and it displays factory rear-view camera and/or PDC-display
	ReverseLogic	Intelligent	For vehicles with PDC button. Enabled while parking process and up to 20 km/h or together with PDC if existing
Gear only		For vehicles without PDC button. Enabled while parking process and up to 20 km/h.	
MISC	OEM PDC CAR	Horizontal	PDC-display of the vehicle is horizontal
		Vertical	PDC-display of the vehicle is vertical

Note: You can deactivate the enabled parking process by pressing the iDrive or by enabling other modes (e.g. radio). After deactivation you can't enable the parking process again until the vehicle is diving faster than 20km/h, the ignition is switched off and on or the PDC will be disabled and enabled again, if existing.

3.3.2.3. Settings for OEM rear-view camera

OSD-menu	Menu item	Setting	Explication
INPUTS	RVC	OEM	If a factory rear-view camera is existing! The interface turns off, if PDC or reverse gear is enabled and it displays factory rear-view camera and/or PDC-display
	Reverse Logic	Intelligent	For vehicles with PDC button. Enabled while parking process and up to 20 km/h or together with PDC if existing

3.3.3. SMART-LINK

The front camera input can alternatively be used for SMART-LINK set (CarPlay® & Android Auto® module) connection. In addition, the interface has the option of controlling the connected SMART-LINK module over the iDrive control panel.

3.3.3.1. SMART-LINK video and control connection

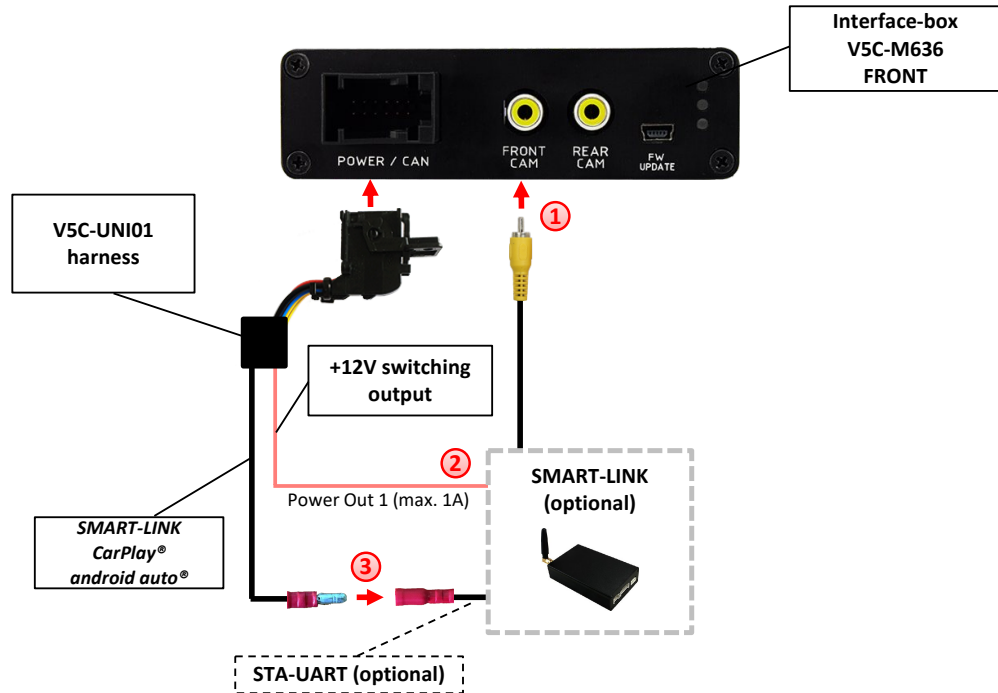

1 Connect the video RCA of the SMART-LINK module to the female RCA connector "FRONT CAM" of the interface box V5C-M636.

2 Connect the pink cable (+12V Power OUT 1) of the V5C-UNI01 harness to the +12V ACC power input of the SMART-LINK module. Configure in the OSD-menu "MISC", menu item "Power Out 1" the setting "CAN" (see also chapter "Configurable switching outputs").

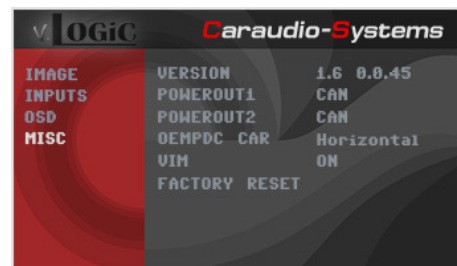

3 Connect the SMART-LINK interface control port "STA-UART" (available separately) to the "SMART-LINK CarPlay® Android Auto®" socket of V5C-UNI01 harness.

3.3.3.2. SMART-LINK audio connection

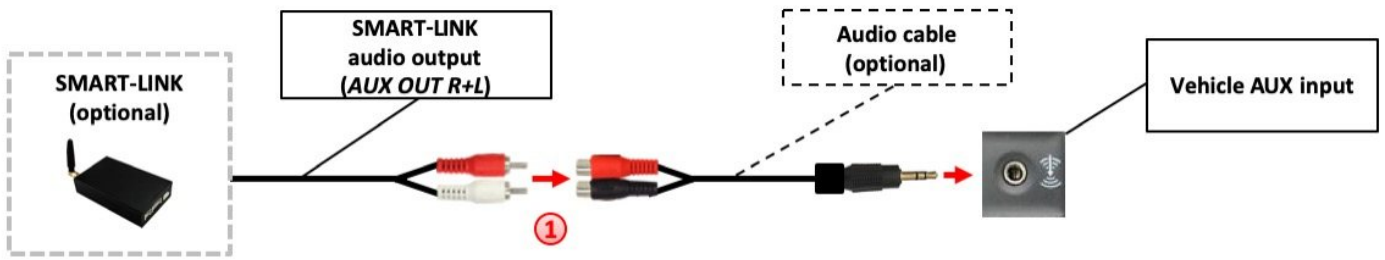

1 By using an audio cable (sold separately), connect the audio output of the SMART-LINK module to the vehicle AUX input.

3.3.3.3. Settings for SMART-LINK connecting

You have to configure some settings in the OSD-menu INPUTS if you want to connect the SMART-LINK module (Operation of the OSD: see chapter "OSD-Operation").



OSD-menu	Menu item	Setting	Explication
INPUTS	FVC	OFF	No front camera/SMART-LINK connected
		SmartPhone	Enables the " FRONT CAM" input and control for the SMART-LINK set

3.3.4. Configurable trigger outputs

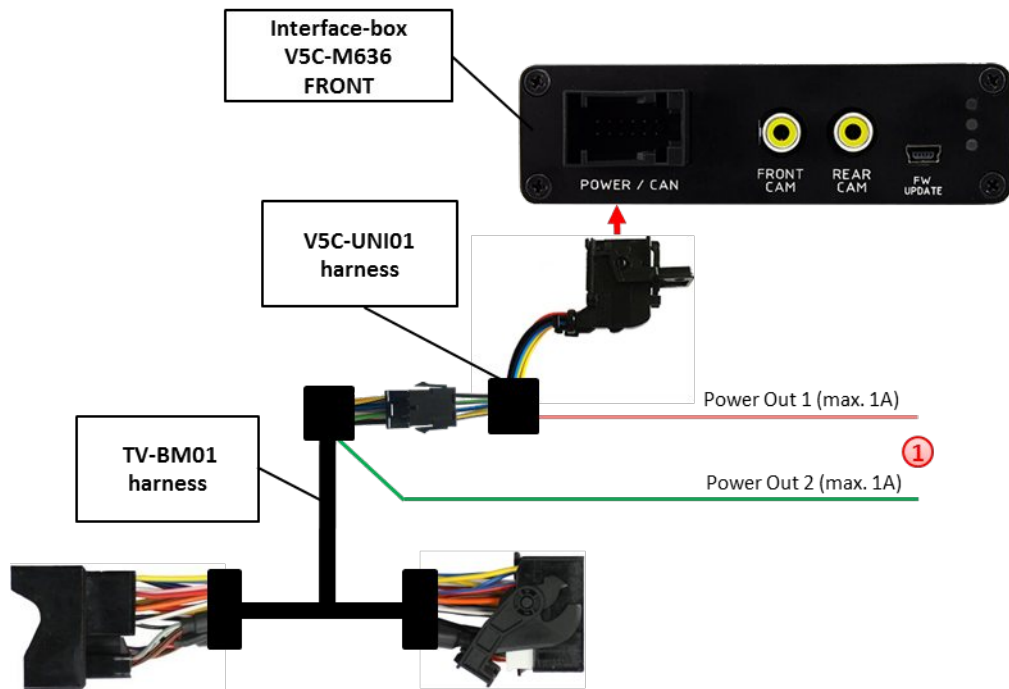

1 You can configure the both +12V trigger outputs separately. The pink wire is POWER OUT 1 and the green wire is POWER OUT 2.

Note: You can configure the both trigger outputs in the OSD-menu MISC separately (Operation of the OSD: see chapter “OSD-Operation”).



OSD-menu	Menu item	Setting	Explication
MISC	POWER OUT1 (pink) POWER OUT2 (green)	CAN	+12V when the interface is on (red LED on)
		Ignition	+12V when ignition is on
		RearCam	+12V when the rear-view camera input is activated
		Reverse Gear	+12V when reverse gear is engaged
		OFF	Trigger putput deactivated

3.4. Picture settings

You can change the picture settings in the OSD-menu IMAGE (activation by **long pressing the OPTION -button**).

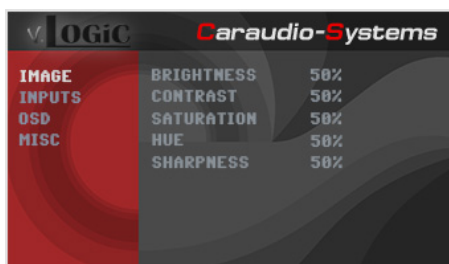

- Brightness
- Contrast
- Saturation
- Hue
- Sharpness



Note: The picture settings will be retained for each video input separately.

3.5. Picture format settings

The picture format can be changed in the SMART-LINK video level by **long pressing the OPTION -button**).

- 8.8" and 10.2" 24:10 ultrawide monitor:

- FULL = 24:10 video full screen mode
- 16:9 = 16:9 video in the center
- AV+LVDS = 16:9 video on left side, factory picture on right side

- 6.5" and 7" 16:9 monitor:

- FULL = 16:9 video full screen mode
- ZOOM = 16:9 video full screen mode - zoom



4. Operation

4.1. OSD – On-screen display

You can change the basic configurations of the interface in the OSD (on screen display).



4.1.1. OSD – Operation

You can control the OSD by iDrive.

4.1.1.1. 8-button iDrive

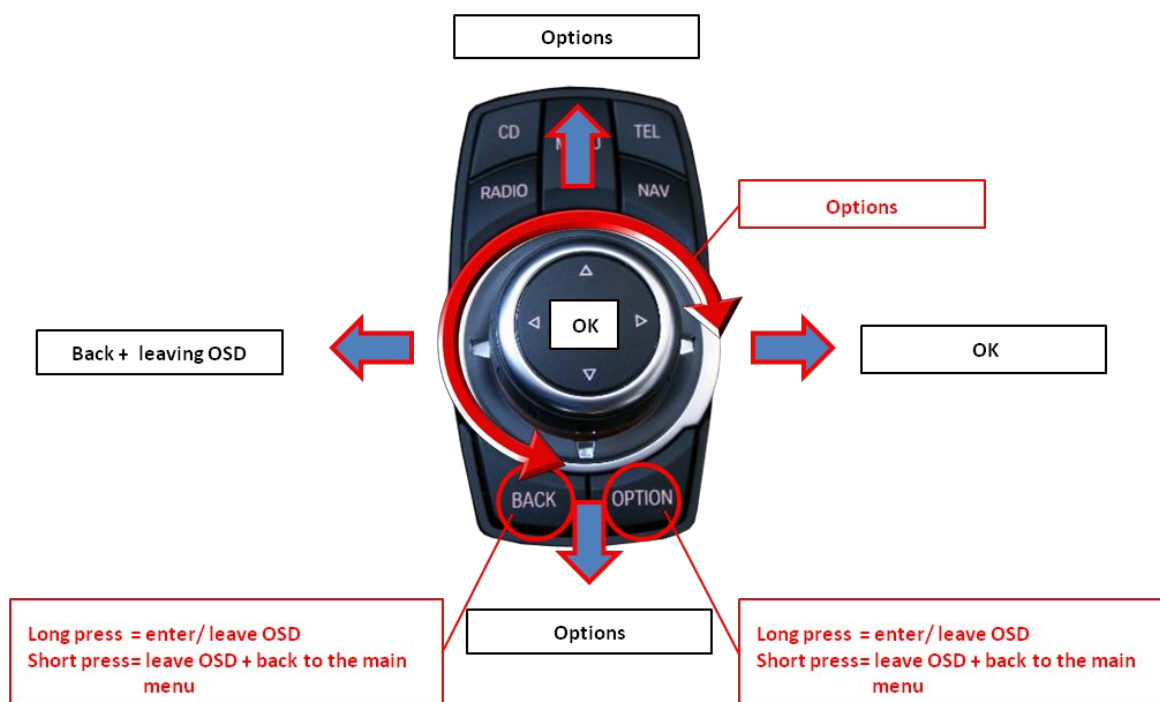

4.1.1.2. 2-button iDrive in Mini

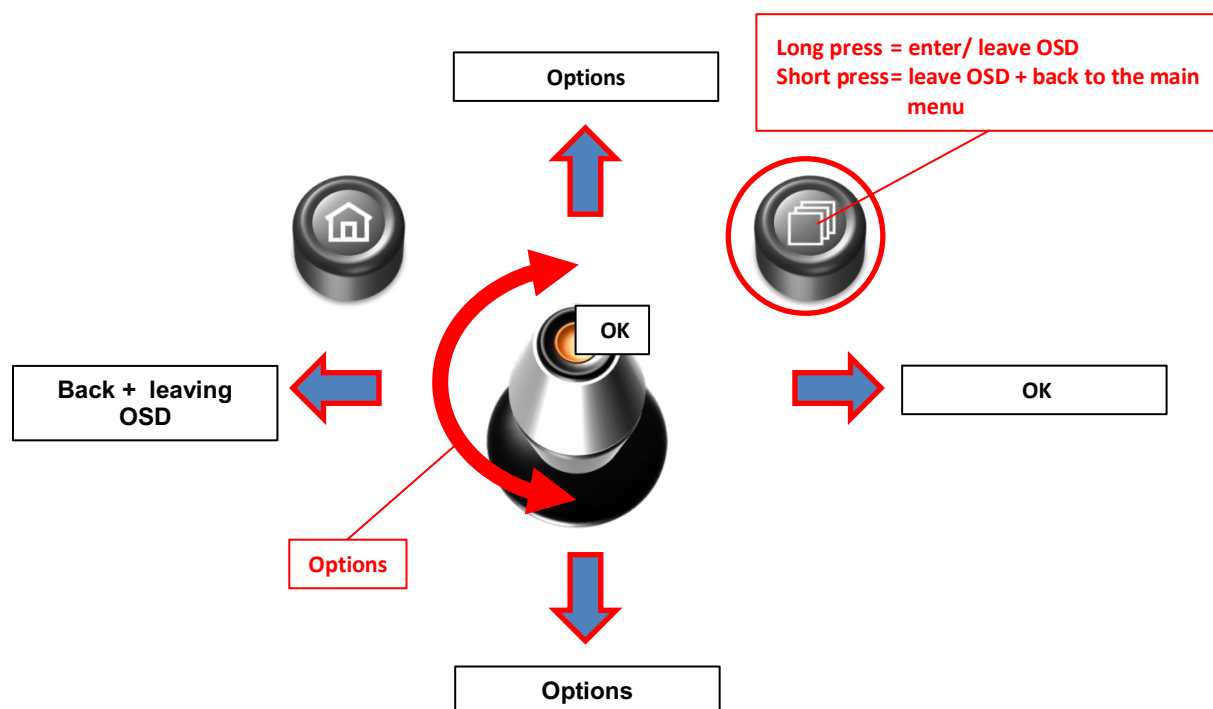

4.1.2. OSD – Additional setting options

The following settings in the OSD-menu OSD and MISC can be configured over and above the described settings in this manual (Operation of the OSD: see chapter “OSD-Operation”):



OSD-menu	Menu item	Setting	Explication
	H POSITION	0-xxx	Horizontal position of the OSD
	V POSITION	0-xxx	Vertical position of the OSD
MISC	VERSION	X.XX.XX	Displays the current SW-version
	FACTORY RESET		Resetting to factory settings

4.2. Video-in-motion function

It is possible to activate and deactivate the video-in-motion in the OSD menu “MISC” (Operation of the OSD: see chapter “OSD-Operation”).



OSD-menu	Menu item	Setting	Explication
MISC	VIM	ON	Video-in-motion activated
		OFF	Video-in-motion deactivated

For the V5-CIC-F-PNP the video-in-motion function is permanently active without disturbing the navigation performance.

4.3. Selecting the interface as current video-source



In the vehicle's **CD/Multimedia > External devices** menu, activate **AUX front** by iDrive and after it **long press CD-button** to choose the interface as current video-source.

Short press CD button to switch the video inputs. Each short press will switch to the next enabled input. If all inputs are enabled the order is:

RVC → FVC/SmartPhone →...

Inputs which are not enabled are skipped.

The exiting of the video interface level is achieved by **long press** of **CD** button or **short press** of **RADIO / MENU / TEL / NAV** button.

Note: Activation of the AUX level is not necessary for camera view.

4.4. Controlling of the connected SMART-LINK module

The picture shows which functions of the connected SMART-LINK module can be executed by iDrive control panel. Once the FVC/SmartPhone input is activated the iDrive control panel action will execute the function described in the picture.

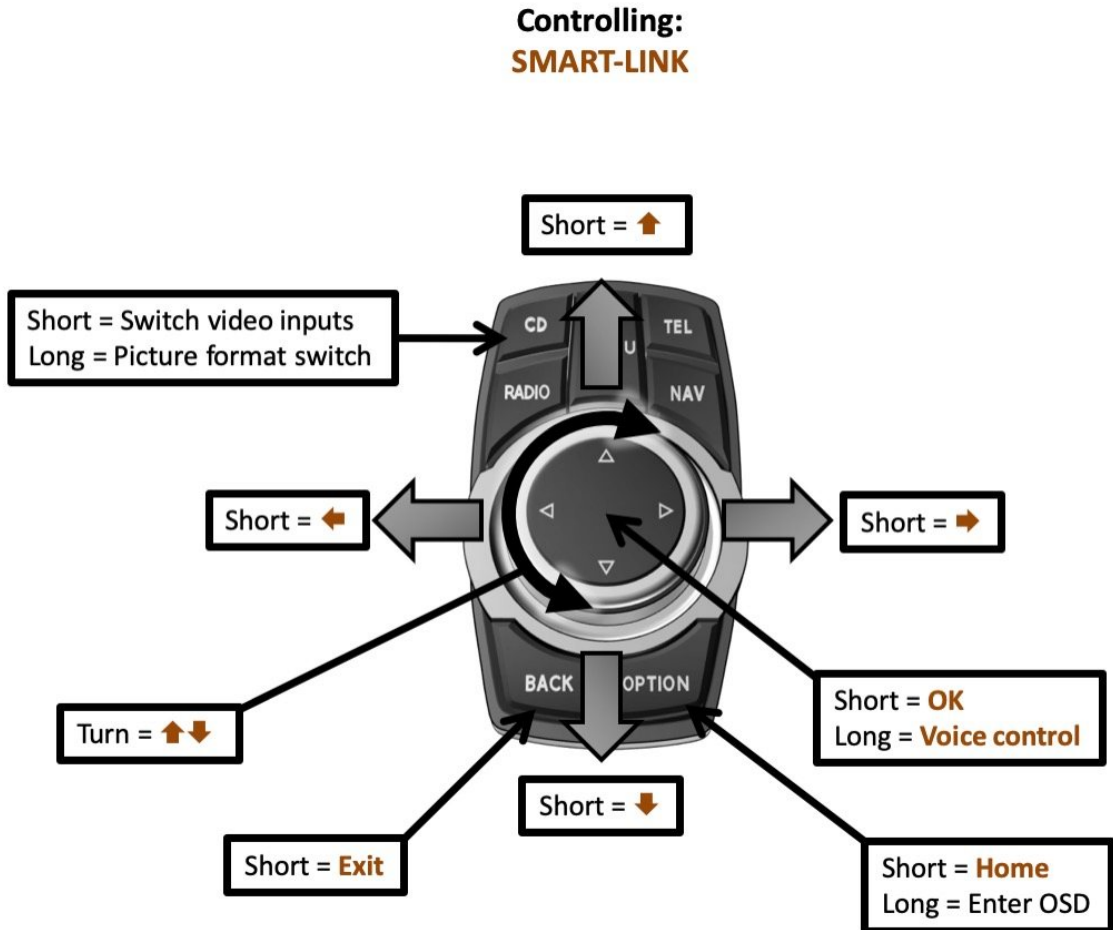

5. Specifications

Operation voltage	10.5 – 14.8V DC
Stand-by power drain	<0,1mA
Operation power drain	190mA
Power consumption	2,6W
Temperature range	-20°C to +80°C
Weight (box only)	285g
Measurements (box only) B x H x T	141 x 30 x 105 mm

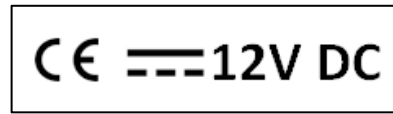

6. Connections (interface-box)

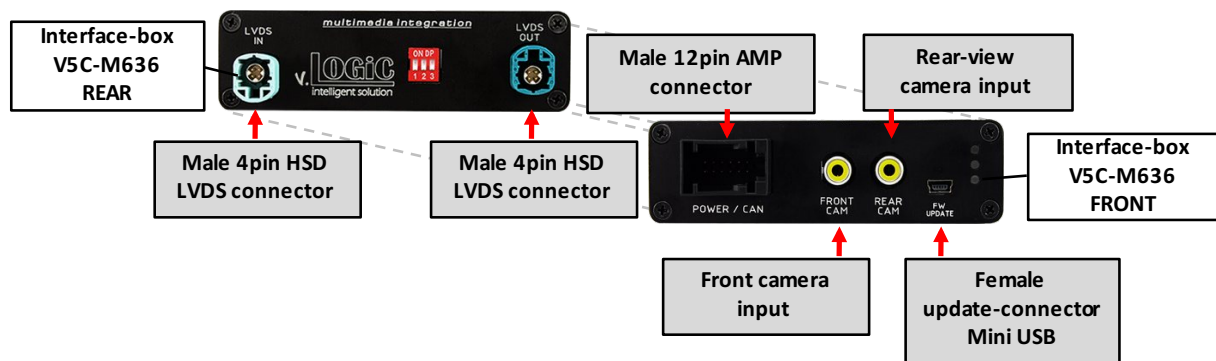

7. Technical Support

Caraudio-Systems Vertriebs GmbH
manufacturer/distribution
In den Fuchslöchern 3
D-67240 Bobenheim-Roxheim

email support@caraudio-systems.de

Legal disclaimer: Mentioned company and trademarks, as well as product names/codes are registered trademarks ® of their corresponding legal owners.