

**v.LOGiC Intelligent Solution
Interface**

V6-MIB

**Compatible with various MIB systems
in Audi, Porsche, Skoda and VW vehicles**

Product features

- Picture-in-picture mode combining after-market rear-view and front camera picture(s) with factory parking sensor graphics
- Interactive lane lines with calibration function
- Simultaneous use of picture-in-picture factory parking sensor graphics and interactive lane lines
- Own on-screen display and setup
- Controls of AV sources (e.g. DVB-T Tuner, ...) by MIB system
- Rear-view camera input
- Automatic switching to rear-view camera input on engagement of reverse gear from all operation modes
- Front camera input
- Side camera inputs
- Side- or front camera activation via blinker signal
- Manual switching to cameras
- 2 trigger outputs (+12V max. 1A), separately adjustable switching events (CAN, ACC, camera, reverse gear)
- Compatible with all factory video accessories
- USB update-port for software-updates by consumer

Contents

1. Prior to Installation

- 1.1. Delivery contents
- 1.2. Check compatibility of vehicle and accessories
- 1.3. Setting the dip switches of the interface-box V6C-M655
- 1.4. LED's of the interface-box V6C-M655

2. Connection schema

3. Installation

- 3.1. Connecting interface-box and harnesses
- 3.2. LVDS connection
 - 3.2.1. After-market front camera
 - 3.2.1.1. Connection to the after-market front camera
 - 3.2.1.2. Settings for connecting an after-market front camera
 - 3.2.2. After-market wide view front camera
 - 3.2.2.1. Connection to the after-market wide view front camera
 - 3.2.2.2. Settings for connecting an after-market wide view front camera
 - 3.2.3. After-market side view cameras
 - 3.2.3.1. Connection of the after-market side view cameras
 - 3.2.3.2. Settings for connecting of after-market side view cameras
 - 3.2.4. After-market rear-view camera
 - 3.2.4.1. Connection to the after-market rear-view camera
 - 3.2.4.2. Settings for connecting an after-market rear-view camera
 - 3.2.4.3. Settings for OEM rear-view camera
 - 3.2.5. AV source
 - 3.2.5.1. AV source video connection
 - 3.2.5.2. AV source audio connection
 - 3.2.5.3. Settings for connecting an AV source
 - 3.2.6. Configurable trigger outputs
- 3.3. Interactive lane lines
 - 3.3.1. Interactive lane lines settings
- 3.4. Picture settings

4. Operation

- 4.1. Main OSD On-screen display
 - 4.1.1. OSD – Operation
 - 4.1.1.1. Audi OSD control
 - 4.1.1.2. VW OSD control
 - 4.1.1.3. Porsche OSD control
 - 4.1.2. OSD – Additional setting options
- 4.2. Selecting the interface as current video source
- 4.3. Assigning device controls
- 4.4. Controlling of the connected AV source
 - 4.4.1. Audi AV source control
 - 4.4.2. VW / Skoda AV source control
 - 4.4.3. Porsche AV source control

5. Specifications

6. Connections (interface-box)

7. Technical support

Legal Information

By law, watching moving pictures while driving is prohibited, the driver must not be distracted. We do not accept any liability for material damage or personal injury resulting, directly or indirectly, from installation or operation of this product. This product should only be used while standing or to display fixed menus or rear-view-camera video when the vehicle is moving, for example the MP3 menu for DVD upgrades.

Changes/updates of the vehicle's software can cause malfunctions of the interface. We offer free software-updates for our interfaces for one year after purchase. To receive a free update, the interface must be sent in at own cost. Labor cost for and other expenses involved with the software-updates will not be refunded.

1. Prior to installation

Read the manual prior to installation. Technical knowledge is necessary for installation. The place of installation must be free of moisture and away from heat sources.

1.1. Delivery contents

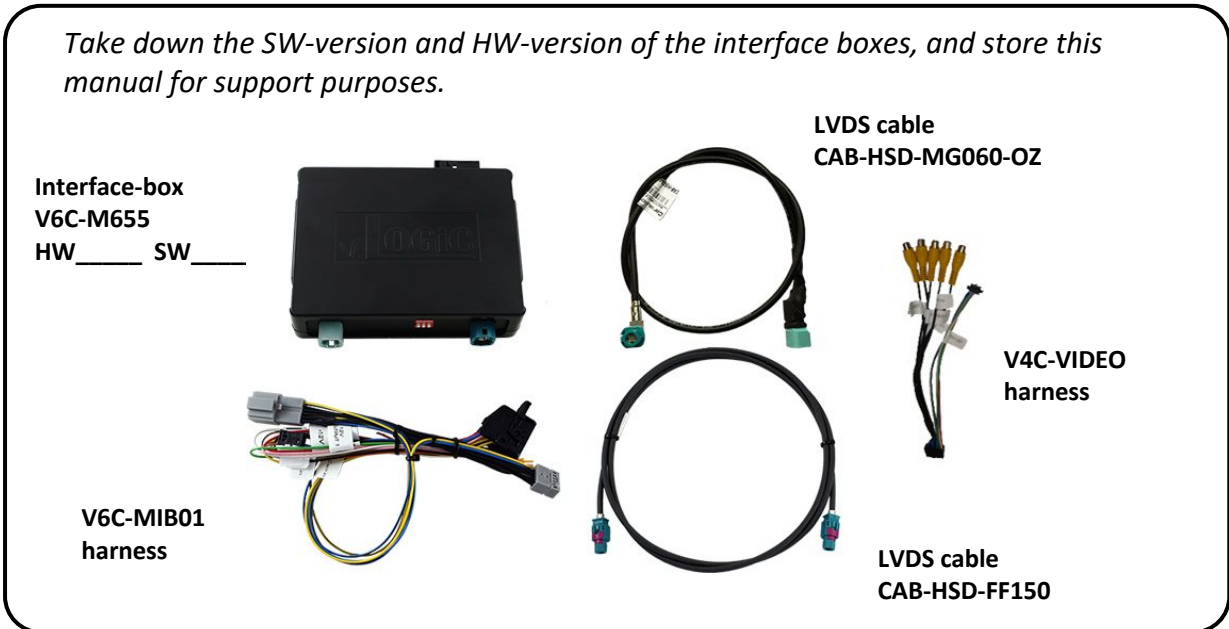

1.2. Check compatibility of vehicle and accessories

Requirements

Brand	Compatible vehicles	Compatible systems
Audi	A3 (8V) from 05/2012-, A4 (8W) from 08/2015-, Q7 (4M) ab 03/2015-	MMI Navigation Plus with MMI touch 7" or 8.3" - MIB/MIB II main-unit
Porsche	Cayenne, Boxster, 911, Cayman	PCM 4.0
Skoda	Octavia 2017-	MIB - Amundsen 8"
VW	Golf7 MY 2015-, Golf7 Sportsvan MJ 2015-, Passat (B8) MY 2015-, T-Roc MY 2017-	MIB/MIB2 - Discovery Pro 8" and Composition Media - 6.5" monitor.

1.3. Setting the dip switches of the interface-box V6C-M655

Dip 1 on the back of the interface-box V6C-M655 are used to set the monitor type. The default setting is:

Vehicle	Monitor	Dip 1	Dip 2	Dip 3
Audi A3 (8V), Audi A4 (8W)	7"	ON	OFF	OFF
Audi A4 (8W)	8,3"	ON	ON	ON
Audi Q7 (4M)	8,3"	ON	OFF	ON
Porsche Cayenne, Boxster, 911, Cayman	7"	ON	ON	OFF
Skoda Octavia 3	8"	OFF	OFF	ON
VW Golf 7, Sportsvan	6,5"	OFF	ON	OFF
VW Passat (B8)	6,5"	OFF	ON	ON
VW Passat (B8), T-Roc	8"	ON	ON	OFF

After each change of the dip switch settings you have to execute a power reset of the interface-box!

1.4. LED's of the interface-box V6C-M655



- Valid input source
- CAN ok
- Power

2. Connection scheme

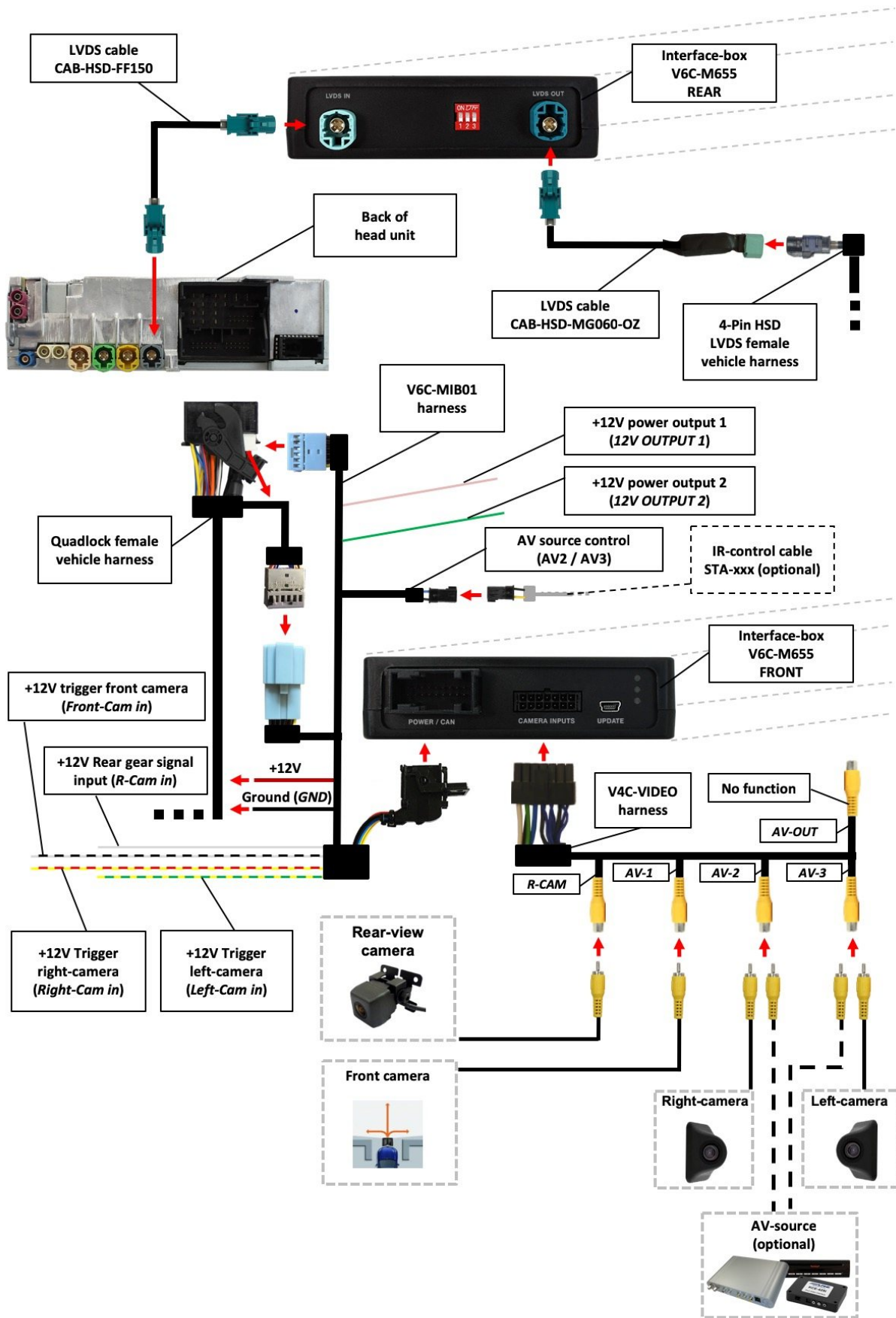

3. Installation

Switch off ignition and disconnect the vehicle's battery! The interface needs a permanent 12V source. If according to factory rules disconnecting the battery is to be avoided, it is usually sufficient to put the vehicle in sleep-mode. In case the sleep-mode does not show success, disconnect the battery with a resistor lead.

If power source is not taken directly from the battery, the connection has to be checked for being start-up proven and permanent.

Prior to wire and device installation we suggest to connect and test correct function of all after-market and factory infotainment equipment!

The interface is installed on the backside of the head unit.

3.1. Connecting interface box and harnesses

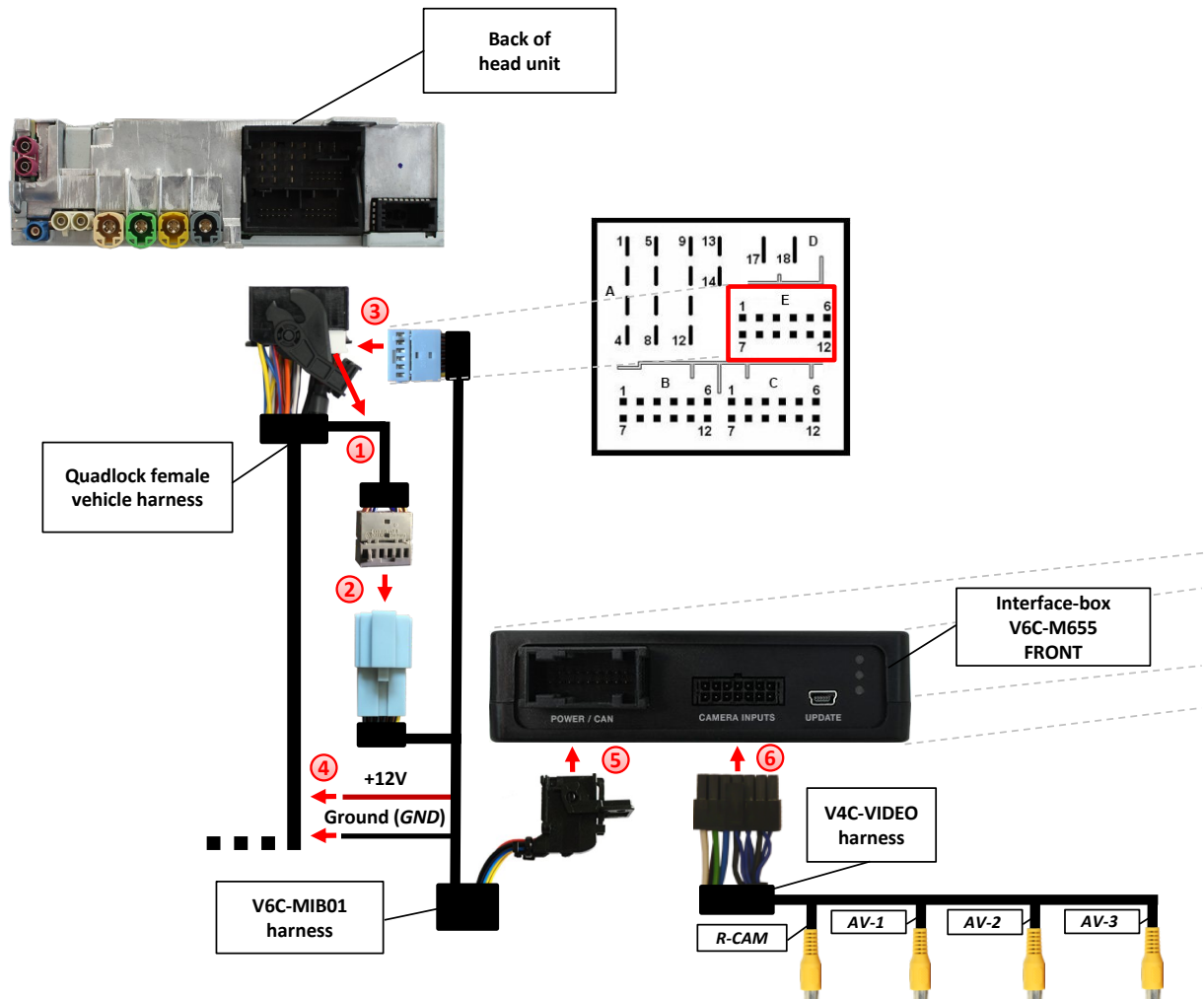

- 1 Disconnect Quadlock connector from the head unit and remove the 12pin connector from chamber "E".
- 2 Plug in the original vehicle Quadlock 12Pin connector to the 12pin socket of the V6C-MIB01 harness.
- 3 Plug in the 12 pin connector of the V6C-MIB01 harness to chamber "E" of the vehicle Quadlock connector.
- 4 Connect red wire with +12V (Quadlock connector pin 18, chamber D) and black wire with ground (Quadlock connector pin 17, chamber D).
- 5 Plug in the 18 pin AMP connector of the V6C-MIB01 harness to 18pin socket of the V6C-M655 interface.
- 6 Plug in the 14pin connector of the V4C-VIDEO harness to 14pin socket of the V6C-M655 interface and connect back the vehicle Quadlock to the head unit.

Connection assignment:

Cable colour	Assignment
● Red	+12V permanent - pin 18
● Brown	Ground - Pin 17
● Orange/Violett	CAN HIGH - Pin 6
● Orange/Brown	CAN LOW - Pin 12

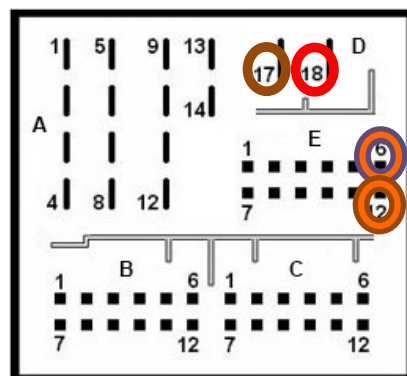

Quadlock

3.2. LVDS connection

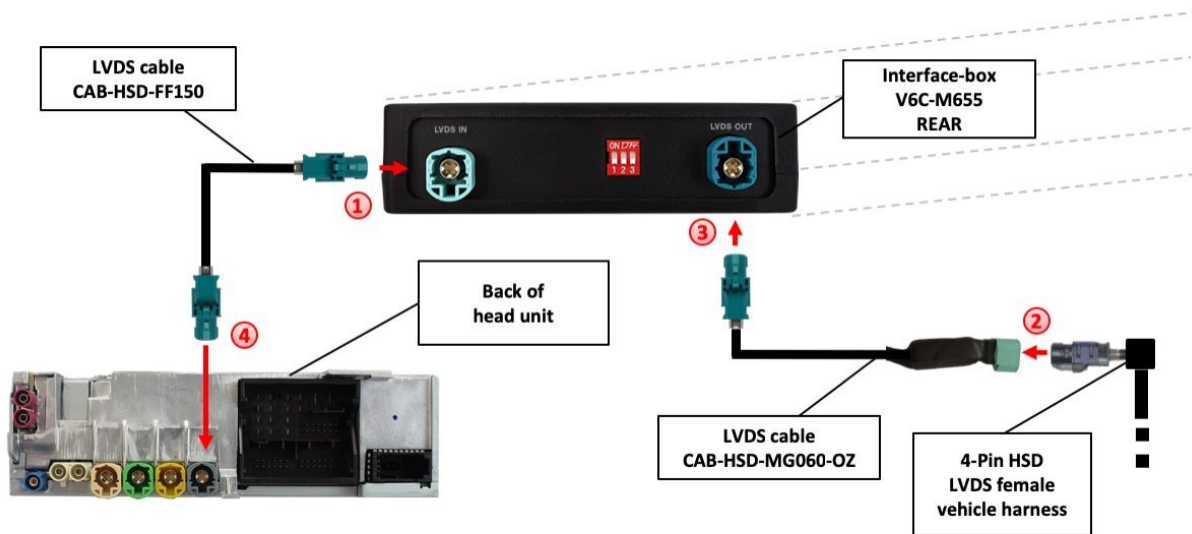

- 1** Connect the female 4pin HSD LVDS connector of the LVDS cable CAB-HSD-FF150 to the male 4pin HSD LVDS connector (LVDS IN) on the rear of the interface-box V6C-M655.
- 2** Remove the **gray / green**(Porsche PCM4.0 only) or **pink** (MIB system specific) female 4pin HSD LVDS connector of the vehicle harness at the back of the head unit and connect it to the male 4pin HSD LVDS of the CAB-HSD-MG060-OZ LVDS cable.
- 3** Connect the female 4pin HSD LVDS connector of the LVDS cable CAB-HSD-MG060-OZ to the male 4pin HSD LVDS connector (LVDS OUT) on the rear of the interface box V6C-M655.
- 4** Connect the female 4pin HSD LVDS connector of the LVDS cable CAB-HSD-FF150 to the **gray/green**(Porsche PCM4.0 only)/**pink** male 4pin HSD LVDS connector on the rear of the head unit.

3.2.1. After-market front camera

3.2.1.1. Connection to the after-market front camera

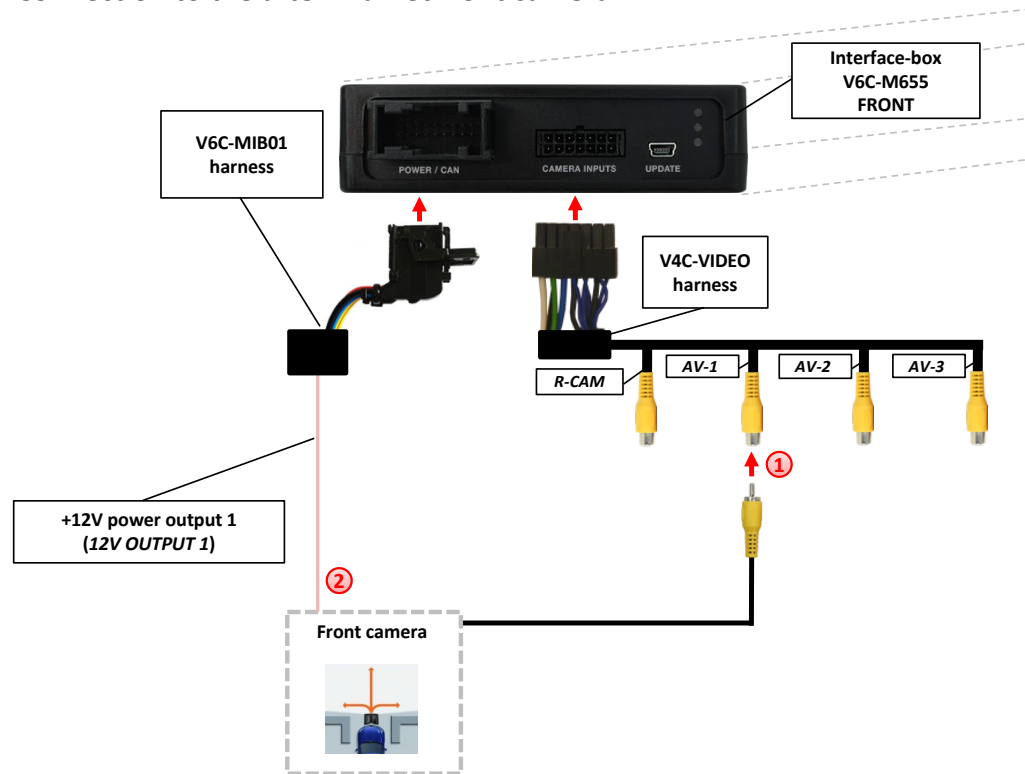

- 1 Connect the video RCA of the after-market front camera to the female RCA connector "AV-1" of the V4C-VIDEO harness.
- 2 The pink wire (12V OUTPUT 1) of harness V6C-MIB01 can be used for +12V electric power supply (max. 1A) of the after-market front camera. Configure in the OSD-menu "Option 1", menu item "Power Out 1" the setting "CAM" (see also chapter "Configurable switching outputs").



3.2.1.2. Settings for connecting an after-market front camera

You have to configure some settings in the OSD-menus Inputs, Option 1 and Option 2 if you want to connect an after-market front camera (Operation of the OSD: see chapter “OSD-Operation”).



OSD-menu	Menu item	Setting	Explication
Input	FVC	OFF	Front camera deactivated
		ON	Switches to front camera if parking process is enabled and reverse gear is released
Option 1	Park Logic	Intelligent	For vehicles with <u>front-PDC</u> . Enabled while parking process and up to 20 km/h
		RGearOnly	Enabled while parking process (<u>not suitable for front camera operation</u>)
		RGearSpeed	Enabled while parking process and up to e.g. 10km (speed adjustable)
		RGearTime	Enabled while parking process and up to 20 second
Option 2	R/F Cam Till	XX	Speed setting for deactivating of the camera image
Option 2	PDC Graphic	OFF	OEM PDC display of the vehicle deactivated
		Horizontal	Vehicles with horizontal OEM PDC display
		Hor. Dark	Vehicles with horizontal OEM PDC display – alternative presentation
		Vertical	Vehicles with vertical OEM PDC display

Note: You can deactivate the camera image by long pressing (2 sec.) the rotation knob.

3.2.2. After-market wide view front camera

3.2.2.1. Connection to the after-market wide view front camera

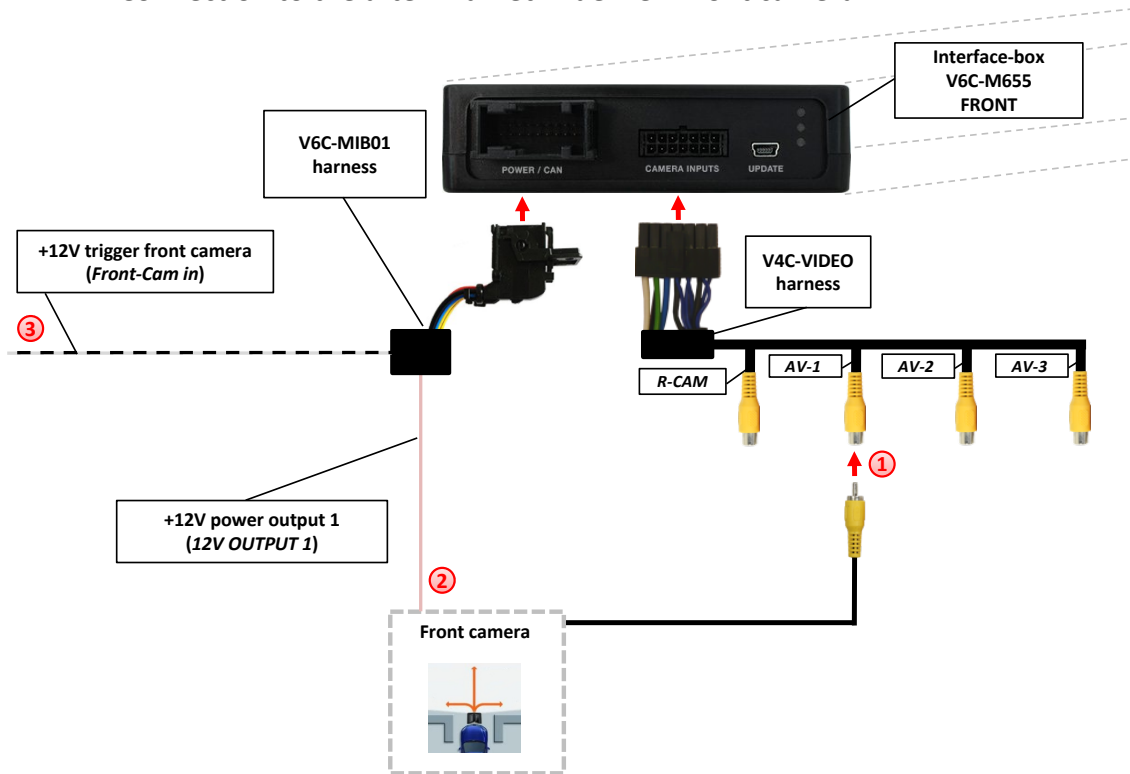

- 1 Connect the video RCA of the after-market wide view front camera to the female RCA connector "AV-1" of the V4C-VIDEO harness.
- 2 The pink wire (12V OUTPUT 1) of harness V6C-MIB01 can be used for +12V electric power supply (max. 1A) of the after-market front camera. Configure in the OSD-menu "Option 1", menu item "Power Out 1" the setting "CAM" (see also chapter "Configurable switching outputs").
- 3 **Exception:** Connect the white/black wire of harness V6C-MIB01 to the right and left analogue blinker signals (triggered +12V blinker power) and make the menu setting - Option 2 / Cam Trigger - „Analogue“, if the system doesn't switch to the aftermarket wide view front camera automatically after the described OSD-setup (Option 2 / Cam Trigger - „CAN“, see next chapter).



3.2.2.2. Settings for connecting an after-market wide view front camera

For the use of a wide view front camera, the interface offers not only manual activation, but also activation via the blinker function. Note: via CAN bus blinker signal detection (menu: Option 2 / Cam Trigger - "CAN"), the activation does not take place in "blinker comfort mode" (brief touch of the blinker lever).

You have to configure some settings in the OSD-menus Inputs, Option 1 and Option 2 if you want to connect an after-market front camera (Operation of the OSD: see chapter "OSD-Operation").



OSD-menu	Menu item	Setting	Explication
Input	FVC	OFF	Front camera deactivated
		ON	Switches to front camera if parking process is enabled and reverse gear is released
Option 1	Park Logic	Intelligent	For vehicles with <u>front-PDC</u> . Enabled while parking process and up to 20 km/h
		RGearOnly	Enabled while parking process (<u>not suitable for front camera operation</u>)
		RGearSpeed	Enabled while parking process and up to e.g. 10km (speed adjustable)
		RGearTime	Enabled while parking process and up to 20 second
Option 2	R/F Cam Till	XX	Speed setting for deactivating of the camera image
Option 2	F/S Cam From	XX	Speed range setting for front- and side cameras (minimum)
Option 2	F/S Cam Till	XX	Speed range setting for front- and side cameras (maximum)
Option 2	Blinker Mode	Front Cam	Activation of the front camera image when the blinker is activated
Option 2	Cam Trigger	CAN	Rear gear and blinker signal detection over CAN Bus
		Analogue	Rear gear and blinker signal detection over analogue +12V signals

Notes: You can deactivate the camera image by long pressing (2 sec.) the rotation knob. The camera activation via the blinker mode is only available for front camera or for the side view cameras. A parallel use of this function for all cameras is not possible.

3.2.3. After-market side view cameras

3.2.3.1. Connection of the after-market side view cameras

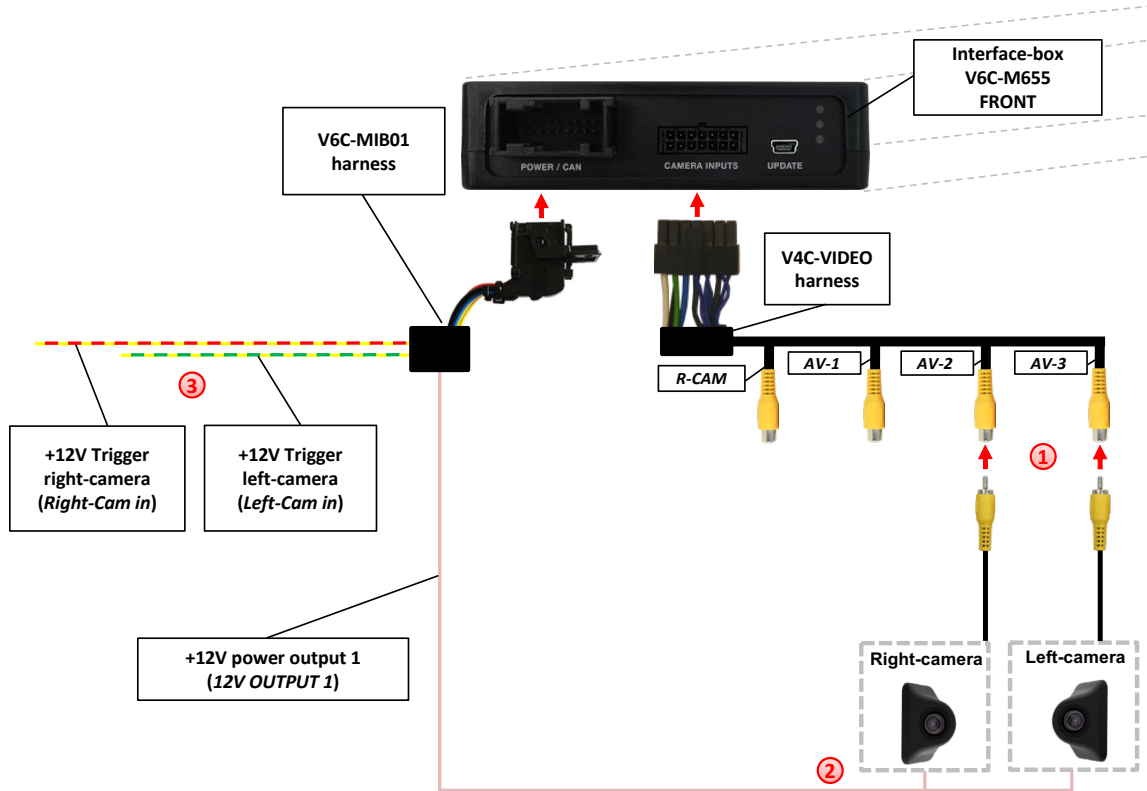

1 Connect the video RCA of the right side view camera to the female RCA connector "AV-2" and the video RCA of the left side view camera to the female RCA connector "AV-3" of the V4C-VIDEO harness.

2 The pink wire (12V OUTPUT 1) of harness V6C-MIB01 can be used for +12V electric power supply (max. 1A) of the after-market side cameras. Configure in the OSD-menu "Option 1", menu item "Power Out 1" the setting "CAM" (see also chapter "Configurable switching outputs").



3 **Exception:** Connect the yellow/red wire to the right analogue blinker signal and the yellow/green wire to the left analogue blinker signal of harness V6C-MIB01 (triggered +12V blinker power) and make the menu setting - Option 2 / Cam Trigger - „Analogue“, if the system doesn't switch to the aftermarket side view camera automatically after the described OSD-setup (Option 2 / Cam Trigger - „CAN“, see next chapter).

3.2.3.2. Settings for connecting of after-market side view cameras

For the use of side view cameras, the interface offers not only manual activation, but also activation via the blinker function. Note: via CAN bus blinker signal detection (menu: Option 2 / Cam Trigger - "CAN"), the activation does not take place in "blinker comfort mode" (brief touch of the blinker lever).

You have to configure some settings in the OSD-menus Inputs, Option 1 and Option 2 if you want to connect an after-market front camera (Operation of the OSD: see chapter "OSD-Operation").



OSD-menu	Menu item	Setting	Explication
Input	Right VC	ON	Right camera input activated
	Left VC	ON	Left camera input activated
Option 1	Park Logic	Intelligent	For vehicles with <u>front-PDC</u> . Enabled while parking process and up to 20 km/h
		RGearOnly	Enabled while parking process (<u>not suitable for front camera operation</u>)
		RGearSpeed	Enabled while parking process and up to e.g. 10km (speed adjustable)
		RGearTime	Enabled while parking process and up to 20 second
Option 2	R/F Cam Till	XX	Speed setting for deactivating of the camera image
Option 2	F/S Cam From	XX	Speed range setting for front- and side cameras (minimum)
Option 2	F/S Cam Till	XX	Speed range setting for front- and side cameras (maximum)
Option 2	Blinker Mode	Side Cam	Activation of the side view cameras image when the blinker is activated
Option 2	Cam Trigger	CAN	Rear gear and blinker signal detection over CAN Bus
		Analogue	Rear gear and blinker signal detection over analogue +12V signals

Notes: You can deactivate the camera image by long pressing (2 sec.) the rotation knob. The camera activation via the blinker mode is only available for front camera or for the side view cameras. A parallel use of this function for all cameras is not possible.

3.2.4. After-market rear-view camera

3.2.4.1. Connection to the after-market rear-view camera

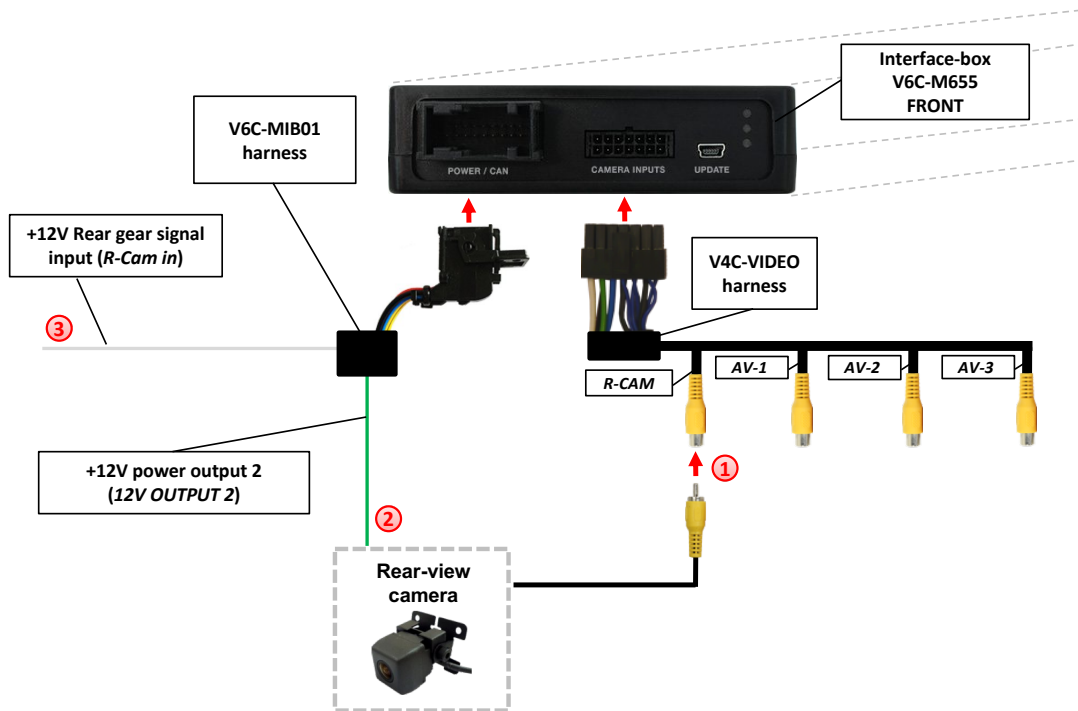

1 Connect the video RCA of the after-market rear-view camera to the female RCA connector “R-CAM” of the V4C-VIDEO harness.

2 The green wire (12V OUTPUT 2) of harness V6C-MIB01 can be used for +12V electric power supply (max. 1A) of the after-market rear-view camera. Configure in the OSD-menu “Option 1”, menu item “Power Out 2” the setting “CAM” (see also chapter “Configurable switching outputs”).



3 **Exception:** Connect the white wire of harness V6C-MIB01 to analogue rear gear signal (+12V) and make the menu setting - Option 2 / Cam Trigger - „Analogue“, if the system doesn’t switch to the aftermarket rear-view camera automatically after the described OSD-setup (Option 2 / Cam Trigger - „CAN“, see next chapter).

3.2.4.2. Settings for connecting an after-market rear-view camera

You have to configure some settings in the OSD-menus Inputs, Option 1 and Option 2 if you want to connect an after-market rear-view camera (Operation of the OSD: see chapter “OSD-Operation”).



OSD-menu	Menu item	Setting	Explication
Input	RVC	OFF	Rear-view camera deactivated
		ON	Switches to rear-view camera if reverse gear is engaged or PDC is activate
Option 1	Park Logic	Intelligent	For vehicles with PDC. Enabled while parking process and up to 20 km/h (<u>not suitable for front camera operation for vehicles without front-PDC</u>)
		RGearOnly	Enabled while parking process (<u>not suitable for front camera operation</u>)
		RGearSpeed	Enabled while parking process and up to e.g. 10km (speed adjustable)
		RGearTime	Enabled while parking process and up to 20 second
Option 1	RVC Lines	ON	Interactive lane lines activated
Option 2	R/F Cam Till	XX	Speed setting for deactivating of the camera image
Option 2	PDC Graphic	OFF	OEM PDC display of the vehicle deactivated
		Horizontal	Vehicles with horizontal OEM PDC display
		Hor. Dark	Vehicles with horizontal OEM PDC display – alternative presentation
		Vertical	Vehicles with vertical OEM PDC display
Option 2	Cam Trigger	CAN	Rear gear and blinker signal detection over CAN Bus
		Analogue	Rear gear and blinker signal detection over analogue +12V signals

Note: You can deactivate the camera image by long pressing (2 sec.) the rotation knob.

3.2.4.3. Settings for OEM rear-view camera

OSD-menu	Menu item	Setting	Explication
Input	RVC	OEM	If a factory rear-view camera is existing! The interface turns off, if reverse gear is enabled and it displays factory rear-view camera
Option 1	Park Logic	Intelligent	For vehicles with <u>front-PDC</u> . Enabled while parking process and up to 20 km/h
		RGearSpeed	Enabled while parking process and up to e.g. 10km (speed adjustable)
		RGearTime	Enabled while parking process and up to 20 second
Option 2	R/F Cam Till	XX	Speed setting for deactivating of the camera image

3.2.5. AV source

The AV-3 or AV-2 input can alternatively be used for AV source connection. In addition, the interface has the option of controlling the connected compatible AV source over the touchscreen / control knob.

3.2.5.1. AV source video connection

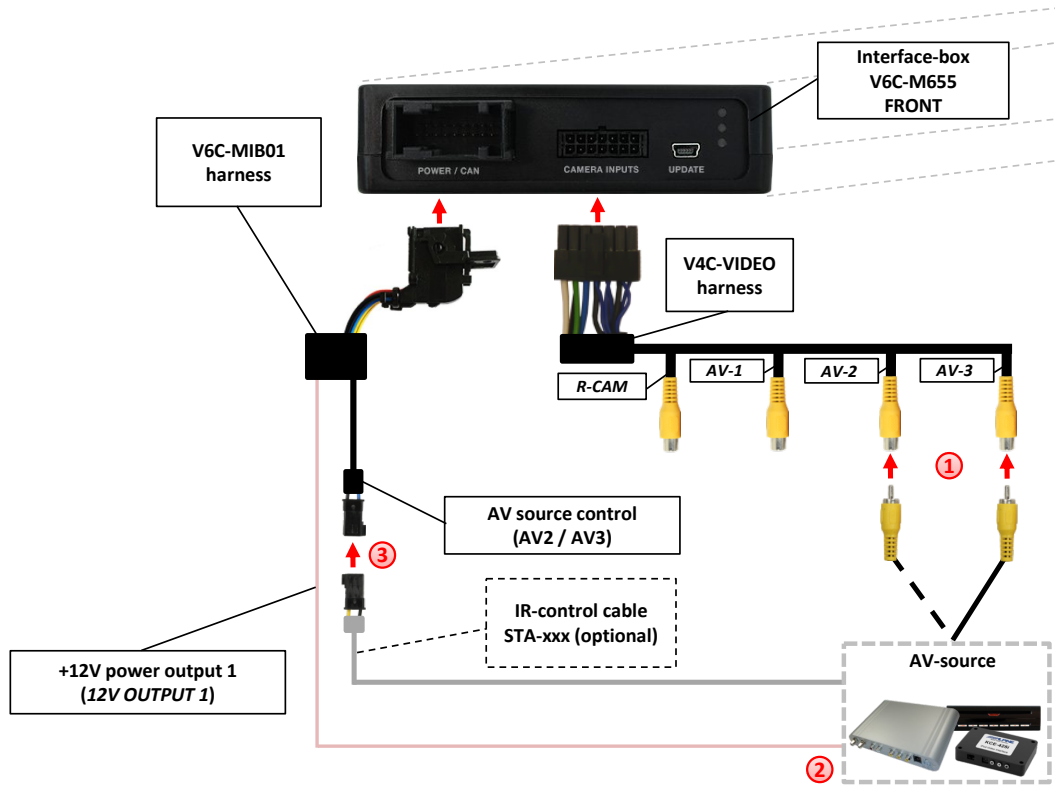

1 Connect video RCA of AV source to female RCA connector "AV-3" or "AV-2" of the video harness V4C-VIDEO.

2 The pink wire (12V OUTPUT 1) of harness V6C-MIB01 can be used for +12V electric power supply (max. 1A) of the AV source. Configure in the OSD-menu "Option 1", menu item "Power Out 1" the setting "AVS" or "ACC" (see also chapter "Configurable switching outputs").

3 **Optional:** Using the respective STA-xxx IR-control cable (available separately), interconnect the female 3pin AMP connector of harness V6C-MIB01 and the IR-port of the AV source.



3.2.5.2. AV source audio connection

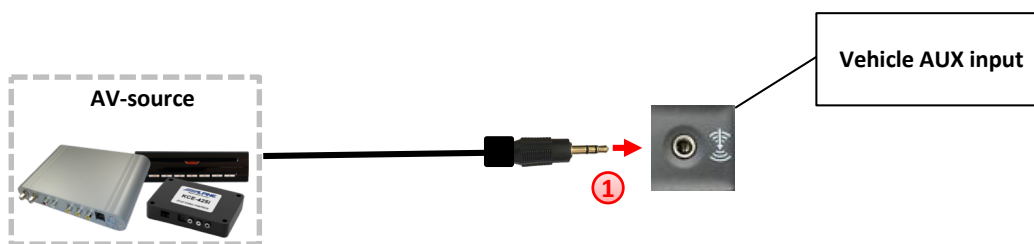

- 1 Connect the audio output of the AV source to the vehicle AUX input.

3.2.5.3. Settings for connecting an AV source

You have to configure some settings in the OSD-menu Input if you want to connect an AV source (Operation of the OSD: see chapter "OSD-Operation").



OSD-menu	Menu item	Setting	Explication
Input	Right VC/AV	OFF	No camera / AV source connected
		RCxx	AV source connected to the AV-2 input
	Left VC/AV	OFF	No camera / AV source connected
		RCxx	AV source connected to the AV-3 input

Note: Select "RC01" if AV source control function via touchscreen / control knob is not used.

3.2.6. Configurable trigger outputs

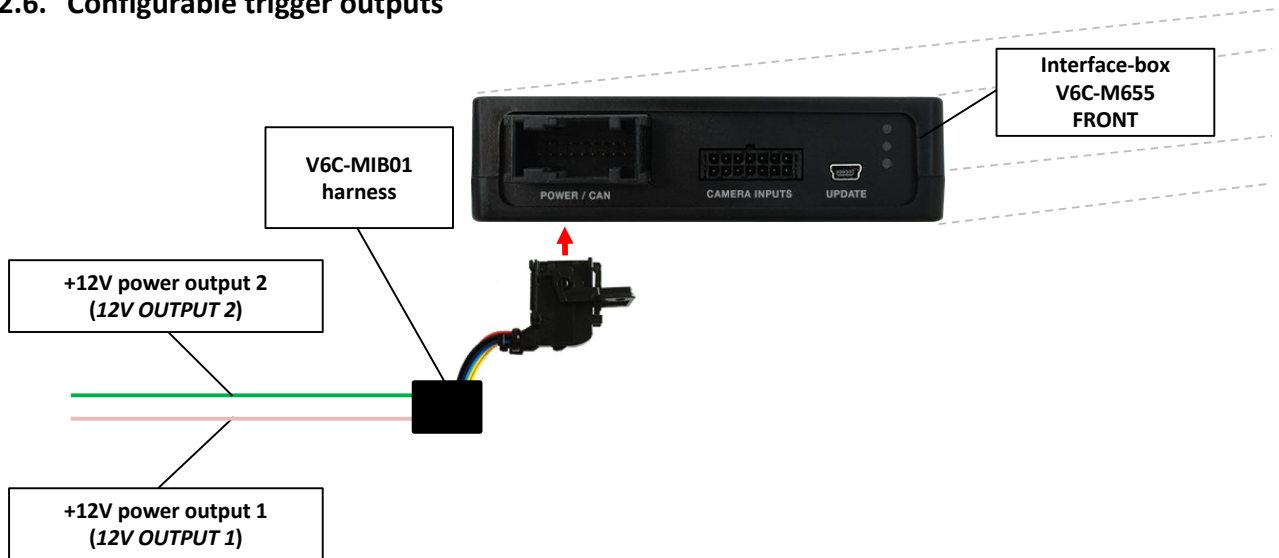

You can configure the both +12V trigger outputs separately. The pink wire is (12V OUTPUT 1) is Power Out 1 and the green wire is (12V OUTPUT 2) is Power Out 2.

Note: You can configure the both trigger outputs in the OSD-menu Option 1 separately (Operation of the OSD: see chapter “OSD-Operation”).



OSD-menu	Menu item	Setting	Explication
OPTION	Power Out 1 (pink)	CAN	+12V when the interface is on (red LED on)
		ACC	+12V when ignition is on
		Cam	+12V when camera input is activated (manually or automatically)
	Power Out 2 (green)	RGear	+12V when reverse gear is engaged
		AVS	+12V when camera / video input was manually activated
		OFF	Trigger output deactivated

Tip: We recommend for all camera modes the power out setting “Cam” and for AV source the power out setting “AVS” or “ACC”.

3.3. Interactive lane lines

You have to configure some settings in the OSD menu Option 1 if you want to activate interactive lane lines (Operation of the OSD: see chapter "OSD-Operation").

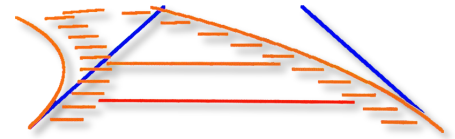

OSD-menu	Menu item	Setting	Explication
Option 1	RVC Lines	OFF	Interactive lane lines deactivated
		ON	Interactive lane lines activated
	Car Type	AUDI_A3/AUDI_A4/ AUDI_Q7/PASSAT/GOLF_7/ CAYENNE/911/Boxster/Cayman/Others	Vehicle type selection

3.3.1. Interactive lane lines settings

The height and width of the interactive lane lines can be set in the OSD menu. For this setting you must at first activate the rear-view camera level and push then the „MENU“/„HOME“(Porsche) button for 2sec. to activate the settings menu. With the rotation knob you can select the menu point "Line Height" to change the height of the interactive lane lines and with menu point "Line Width" the width of the lines. Over the menu point "Exit" you can leave this settings menu.

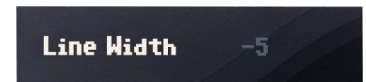
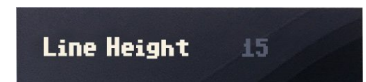

3.4. Picture settings

The camera picture settings can be set in the OSD menu. For this setting you must at first activate the camera level and push then the „MENU“/„HOME“(Porsche) button for 2sec. to activate the settings menu. With the rotation knob you can select and change the "Brightness", "Contrast", "Saturation", Hue" and "Sharpness" menu points. Over the menu point "Exit" you can leave this settings menu.

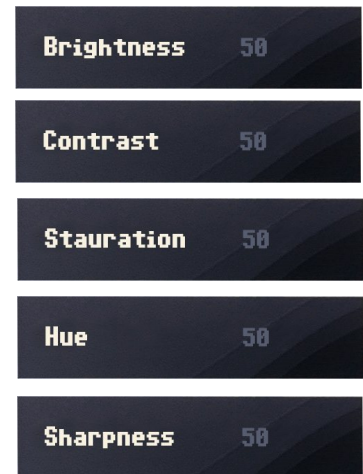

Note: The picture settings will be retained for every camera input separately.

4. Operation

4.1. Main OSD On-screen display

You can change the basic configurations of the interface in the OSD (on screen display).



4.1.1. OSD – Operation

The OSD menu can be controlled via the following buttons:

4.1.1.1. Audi OSD control

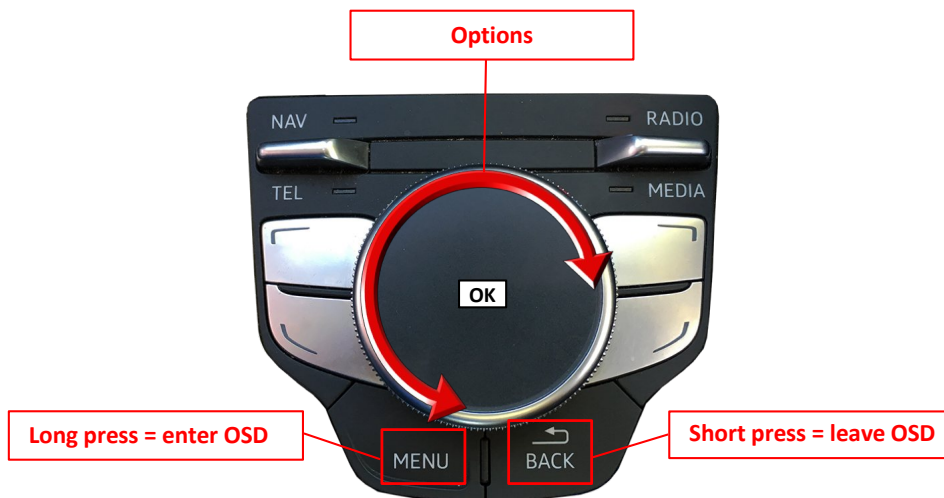

4.1.1.2. VW / Skoda OSD control

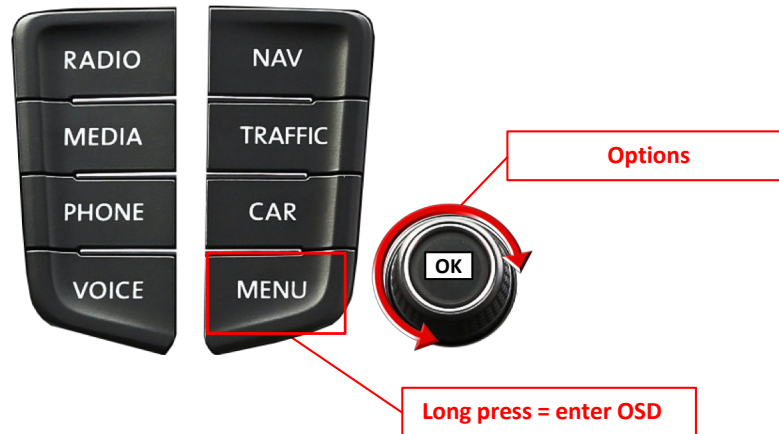

4.1.1.3. Porsche OSD control



4.1.2. OSD – Additional setting options

The following settings in the OSD menus Option 1 and OSD can be configured over and above the described settings in this manual (Operation of the OSD: see chapter “OSD-Operation”):



OSD-menu	Menu item	Setting	Explication
Osd	POS. X	0-xxx	Horizontal position of the OSD
	POS. Y	0-xxx	Vertical position of the OSD
	Size	Small	Small OSD menu windows
		Large	Large OSD menu windows
	Osd TimeOut	2-20	Time setting for automatic OSD shutoff
Info	Version	X.XX.XX	Displays the current SW-version
Option 1	Factory Reset		Resetting to factory settings

4.2. Selecting the interface as current video source



In the vehicle's **Media** menu, activate **AUX** level (only necessary for AV source operation) and **press long "MEDIA" button** to choose the interface as current video source.

Short press "MEDIA" button (or additionally on touchscreen the swipe gesture) switch the video sources (cameras/AV source). Each short press will switch to the next enabled input. If all inputs are enabled the order is:

Rear CAM → Front CAM → Right Cam/AV → Left Cam/AV → ...

Inputs which are not enabled are skipped.

The exiting of the video interface level is achieved by **long press** of **"MEDIA"** button or by **short press** of **"RADIO/TUNER/NAV/MAP/TEL/PHONE/SOURCE/CAR"** (MIB system specific) button.

4.3. Assigning device controls

You can assign the device controls in the OSD-menu Input (Operation of the OSD: see chapter “OSD-Operation”). Assign related IR-codes for Left VC/AV or Right VC/AV input as described in device control table (see appendix A).

LOGIC		Caraudio-Systems	
Input	RVC	ON	
Option 1	FVC	ON	
Option 2	Right VC/AV	OFF	
	Left VC/AV		RC01
Osd	BACK		
Info			
Exit			

Note: Select "RC01" if AV source control function via touchscreen / control knob is not used.

4.4. Controlling of the connected AV source

The picture shows which functions of the connected devices can be executed by touch screen / control knob. Once an AV-input is activated the touchscreen control knob action will execute the function described in the picture. The function description equals the remote control buttons of the device's remote control. On the additional device the writing on the remote control buttons may vary (e.g. AV instead of Source).

4.4.1. Audi AV source control

Controlling of AV-sources: DVB-T / DVD / DAB

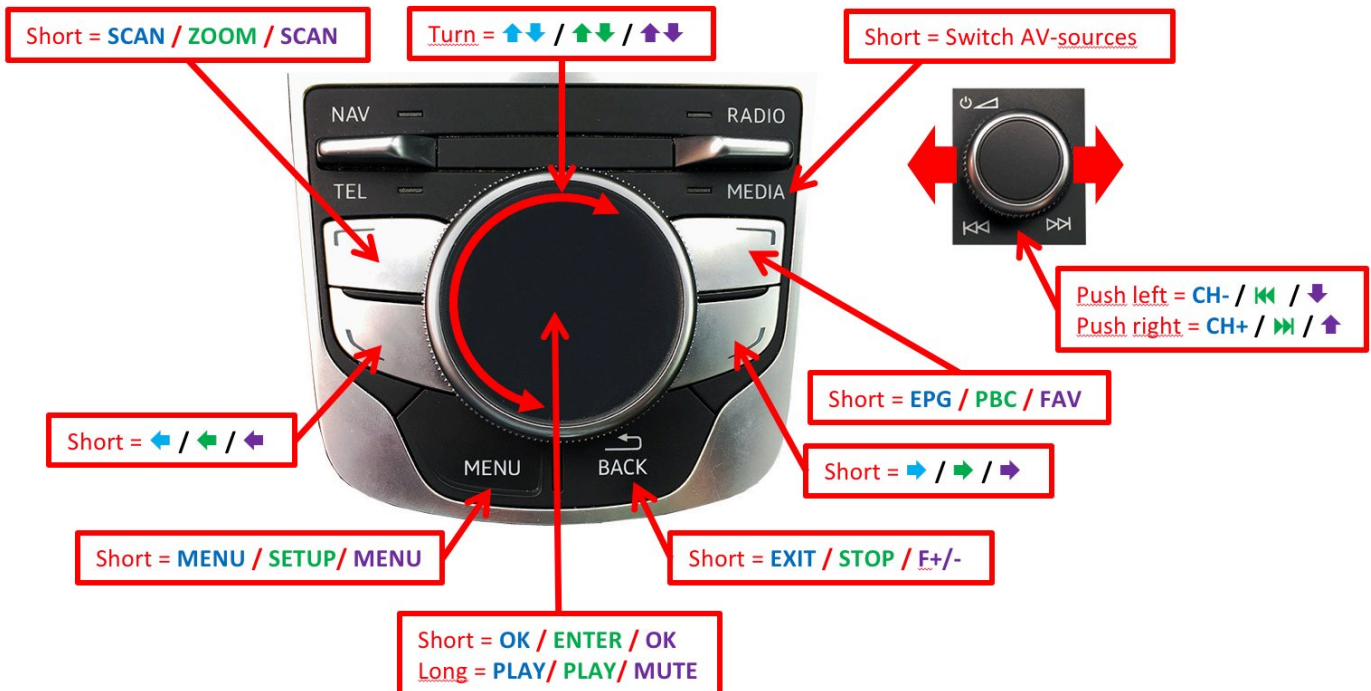

Note: A few functions could be different on some connected devices.

4.4.2. VW / Skoda AV source control

Controlling of AV-sources: DVB-T / DVD / DAB

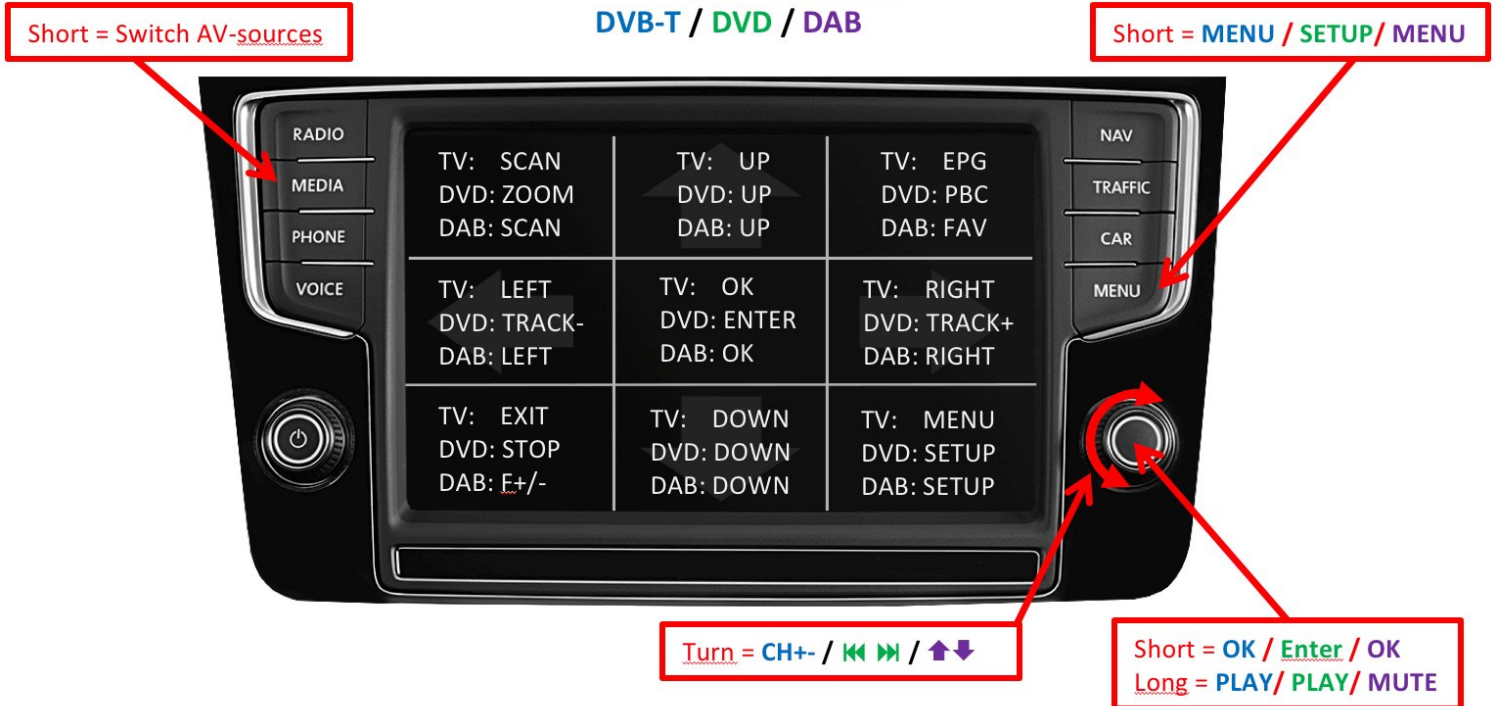

Note: A few functions could be different on some connected devices.

4.4.3. Porsche AV source control

Controlling of AV-sources: DVB-T / DVD / DAB

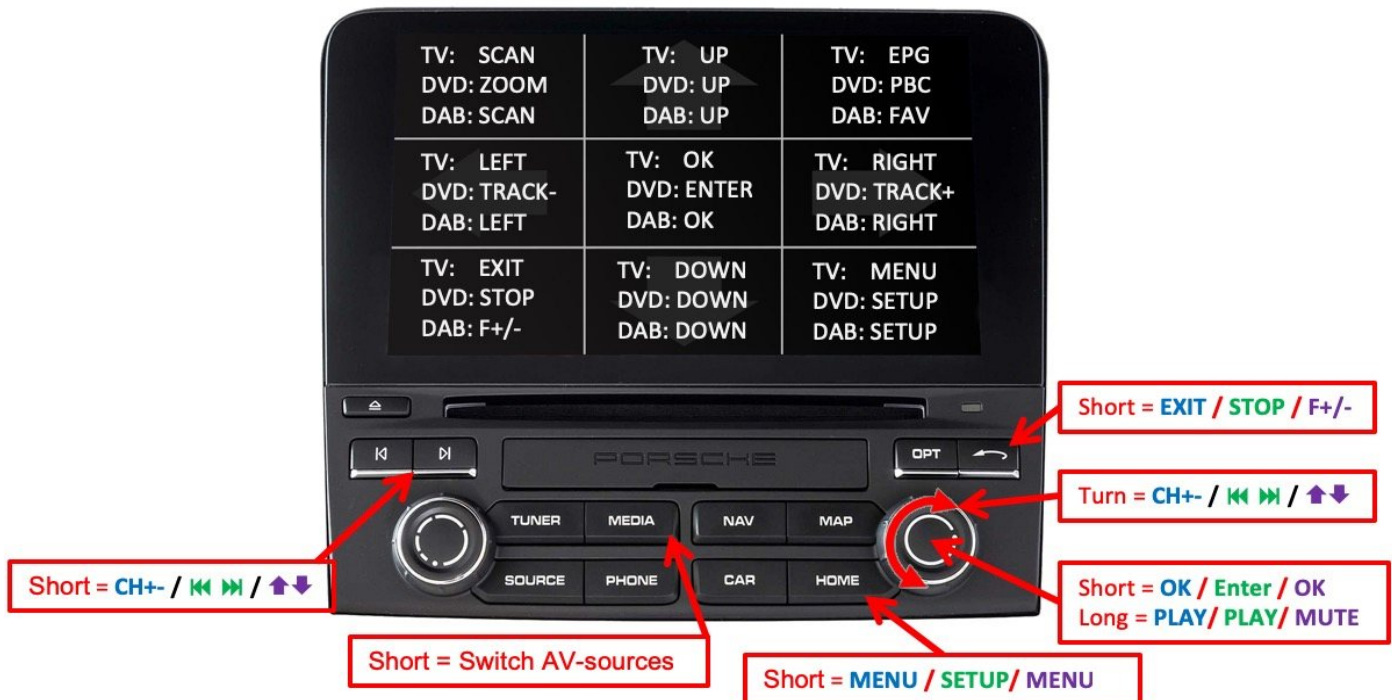

Note: A few functions could be different on some connected devices.

5. Specifications

Operation voltage	10.5 – 14.8V DC
Stand-by power drain	1mA
Operation power drain	190mA
Power consumption	2,6W
Temperature range	-20°C to +80°C
Weight (box only)	285g
Measurements (box only) B x H x T	141 x 30 x 105 mm

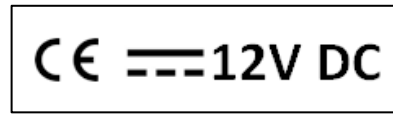

6. Connections (interface-box)

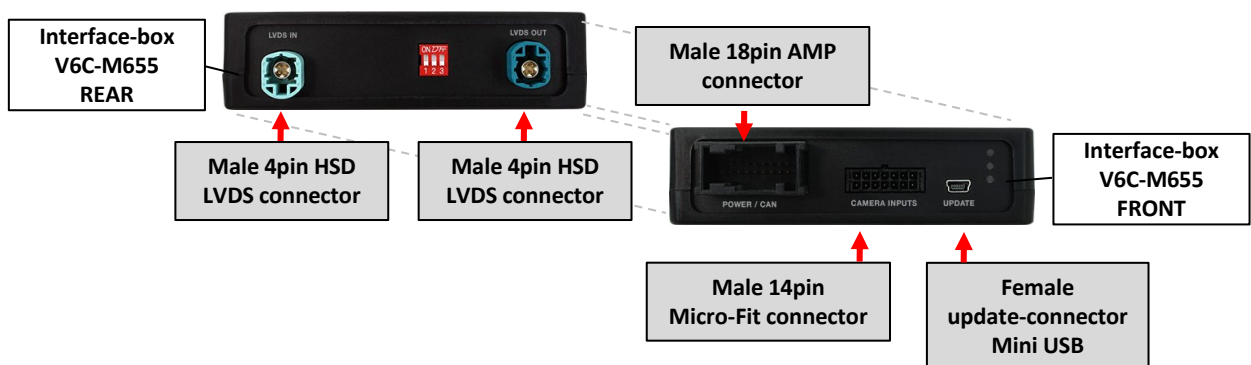

7. Technical Support

Caraudio-Systems Vertriebs GmbH
manufacturer/distribution
In den Fuchslöchern 3
D-67240 Bobenheim-Roxheim

email support@caraudio-systems.de

Legal disclaimer: Mentioned company and trademarks, as well as product names/codes are registered trademarks ® of their corresponding legal owners.