

## **v.LiNK Video-inserter**

### **VL2-DVD900**

#### **for Opel and Chevrolet with DVD900, DVD600 and CD600 IntelliLink navigation systems**

**Video-inserter with 2 video + RGB + rear-view camera input**

##### **Product features**

- **Video-inserter for factory-infotainment monitors**
- **2 video-inputs for after-market devices (e.g. DVD-Player, DVB-T tuner, ...)**
- **Built-in audio-switch (no audio-insertion)**
- **Rear-view camera video-input**
- **Automatic switching to rear-view camera input on engagement of reverse gear**
- **Activatable parking guide lines for rear-view camera**
- **RGB-input for after-market navigation**
- **Video-in-motion (ONLY for connected video-sources)**
- **Compatible with factory rear-view camera**
- **AV-inputs PAL/NTSC compatible**

## Contents

### 1. Prior to installation

- 1.1. Delivery contents
- 1.2. Checking the compatibility of vehicle and accessories
- 1.3. Dip-switch settings
  - 1.3.1. Vehicle selection (dip 7-8)
    - 1.3.1.1. Video signal selection after-market navigation (Dip 4)
  - 1.3.2. Enabling the interface's video inputs (dip 1-3)
  - 1.3.3. Rear-view camera settings (dip 5)

### 2. Installation

- 2.1. Place of installation
- 2.2. Connection schema
- 2.3. Connecting video-interface and 6pin cable
- 2.4. Connection to the factory monitor
- 2.5. Connecting peripheral devices
  - 2.5.1. Video-sources to IN1 and IN2
  - 2.5.2. Audio-switch and audio-insertion
  - 2.5.3. After-market rear-view camera
  - 2.5.4. After-market navigation
- 2.6. Connecting video-interface and keypad
- 2.7. Picture settings
- 2.8. Activation of parking guide lines for rear-view camera

### 3. Interface operation

### 4. Specifications

### 5. Connections (video-interface)

### 6. Technical support

## Legal Information

By law, watching moving pictures while driving is prohibited, the driver must not be distracted. We do not accept any liability for material damage or personal injury resulting, directly or indirectly, from installation or operation of this product. This product should only be used while standing or to display fixed menus or rear-view-camera video when the vehicle is moving, for example the MP3 menu for DVD upgrades.

Changes/updates of the vehicle's software can cause malfunctions of the interface. We offer free software-updates for our interfaces for one year after purchase. To receive a free update, the interface must be sent in at own cost. Labor cost for and other expenses involved with the software-updates will not be refunded.

## 1. Prior to installation

Read the manual prior to installation.

Technical knowledge is necessary for installation. The place of installation must be free of moisture and away from heat sources.

### 1.1. Delivery contents



**1.2. Checking the compatibility of vehicle and accessories**

<b>Requirements</b>	
<i>Vehicle</i>	Opel Insignia, Astra J, Meriva and other vehicles from 2012 Chevrolet Cruze, Orlando
<i>Head-unit/monitor</i>	DVD900, DVD600 and CD600 intelliLink
<b>Limitations</b>	
<i>Video only</i>	The interface inserts ONLY video signals into the infotainment. For sound use the possibly existing factory-audio-AUX-input or a FM-modulator.

**1.3. Dip-switch settings**

With the video interface boxes dip-switches it is possible to select vehicle/navigation the interface is to be installed in (dip 7 and 8), to select the video signal of an optional connected after-market navigation (Dip 4), to dis- or enable the interfaces inputs (dip 1 to 3) and to preselect the type of camera which is (to be) installed (dip 5).



Dip position down is ON and position up is OFF.

**1.3.1. Vehicle selection (dip 7-8)**

Choose the vehicle/navigation/monitor the interface is to be installed to and set dip 7 through 8 according to the below table.

<b>Vehicle/Navigation</b>	<b>Resolution</b>	<b>Dip 7</b>	<b>Dip 8</b>
Lexus	800x480	OFF	OFF
Old GVIF protocol	400x240	ON	ON
Old GVIF protocol	800x480	ON	OFF
New GVIF protocol	400x240	OFF	ON
New GVIF protocol CD600 intelliLink	800x480	OFF	OFF

**Note:** Change Dip 7 if a black bar appears on the right side of the display, change Dip 8 if there are multiple pictures or a moving picture

### 1.3.2. Video signal selection after-market navigation(Dip 4)

To the video interface's RGB-input it is possible to connect a RGB- or a VGA-video source. Set dip 4 according to table.

After-Market Navigation	Dip 4
VGA (RGB-Input Pin 4 H-Sync, Pin 8 V-Sync)	ON
RGB NTSC	OFF

### 1.3.3. Enabling the interface's video inputs (dip 1-3)

Only the enabled video inputs can be accessed when switching through the video sources. It is recommended to enable only the required inputs for the disabled will be skipped when switching through the video interfaces inputs.

Dip	Video-input	ON (down)	OFF (up)
Dip 1	RGB	enabled	disabled
Dip 2	Video IN1	enabled	disabled
Dip 3	Video IN2	enabled	disabled

### 1.3.4. Rear-view camera settings (dip 5)

Depending on whether no camera, after-market camera or factory camera shall be used, dip 5 must use different settings. If set to OFF, the interface switches to factory LVDS picture when the reverse gear is engaged to display factory rear-view camera or factory PDC picture.

Rear-view camera type	Dip 5
None	OFF
Factory	OFF
After-market	ON

**Note:** If the GM-LAN-bus does not work while connecting an after-market rear-view camera, cut the green cable of the 6pin to 8pin cable at the black 8pin connector and connect it to the reverse gear light (+12V). For this use a relay because the reverse gear light of the vehicle is clocked (relay AC-RW1230 and AC-RS5 optional available).

## 2. Installation

**Switch off ignition and disconnect the vehicle's battery! The interface needs a permanent 12V source. If according to factory rules disconnecting the battery is to be avoided, it is usually sufficient to put the vehicle in sleep-mode. In case the sleep-mode does not show success, disconnect the battery with a resistor lead.**

**If power source is not taken directly from the battery, the connection has to be checked for being start-up proven and permanent.**

### 2.1. Place of installation

The interface is installed on the backside of the factory monitor.

2.2. Connection schema

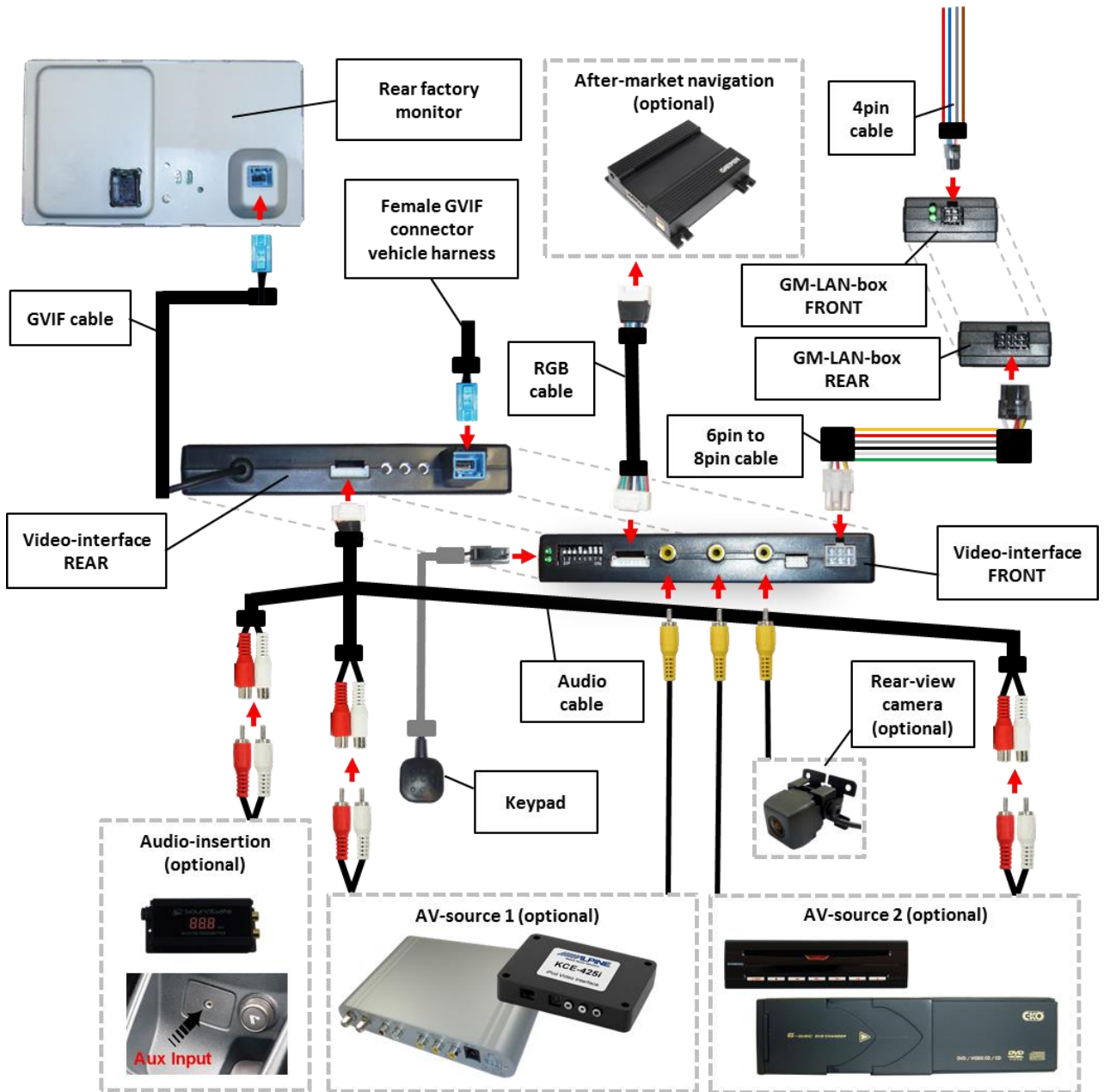

2.3. Connecting video-interface and 6pin cable

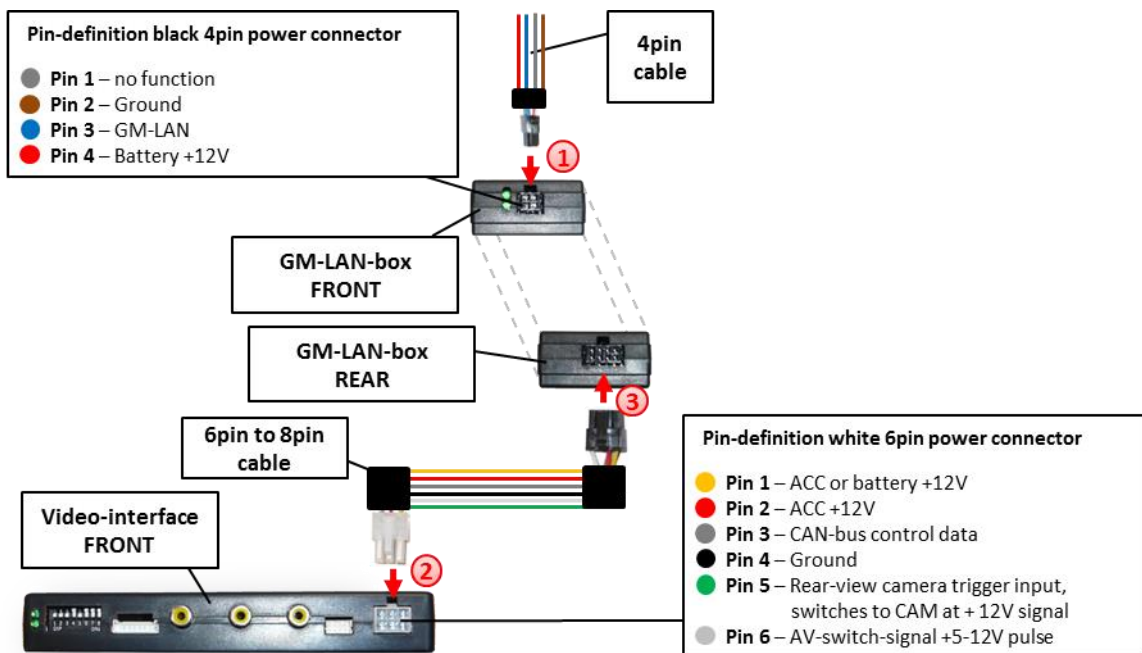

- 1) Connect black female 4pin Micro-Fit connector of the 4pin cable to the male 4pin Micro-Fit connector of the GM-LAN-box.

**Note:** Check LEDs on CAN-box after reconnecting the battery, one must be on.

- 1) GM-LAN
- 2) +12V Battery
- 3) Ground

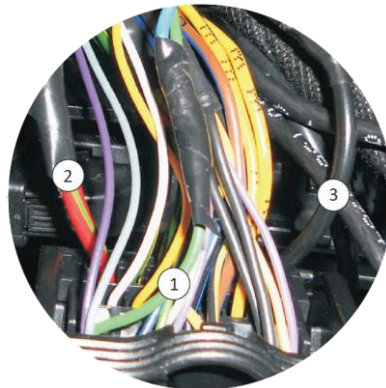

vehicle connector

- 2) Connect white female 6pin Molex connector of the 6pin to 8pin cable to the male 6pin Molex connector of the video-interface.
- 3) Connect black female 8pin Micro-Fit connector of the 6pin to 8pin cable to male 8pin Micro-Fit connector of the GM-LAN-box.

**Note:** Check LEDs on video-interface after reconnecting the battery, one must be on.



## 2.4. Connections to the factory monitor

Remove factory monitor.

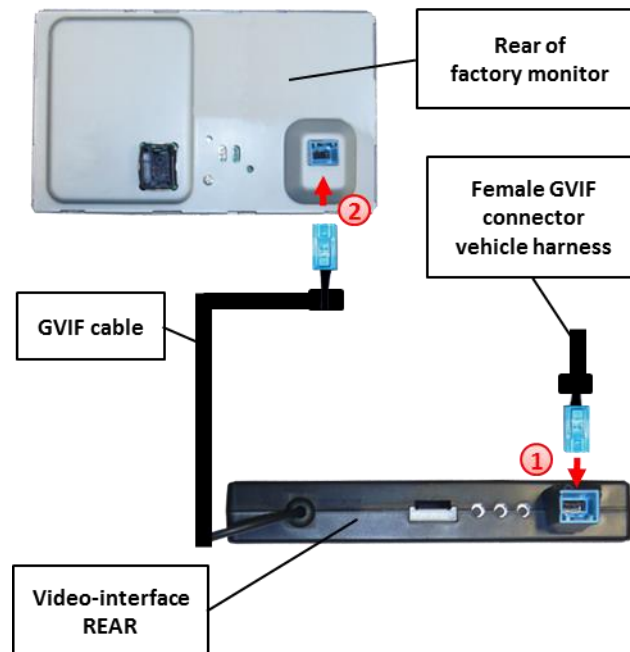

- ① Remove female GVIF connector from the rear of the factory monitor and connect it to the GVIF connector of the video-interface.
- ② Connect female GVIF connector of the GVIF cable to the male GVIF connector of the factory monitor.

## 2.5. Connecting peripheral devices

It is possible to connect 2 after-market AV-sources, an after-market rear-view camera and an after-market navigation to the video-interface.

**Before final installation of the peripheral devices, we recommend a test-run to detect incompatibility of vehicle and interface. Due to changes in the production of the vehicle manufacturer is always the possibility of incompatibility.**

### 2.5.1. Video-sources to IN1 and IN2

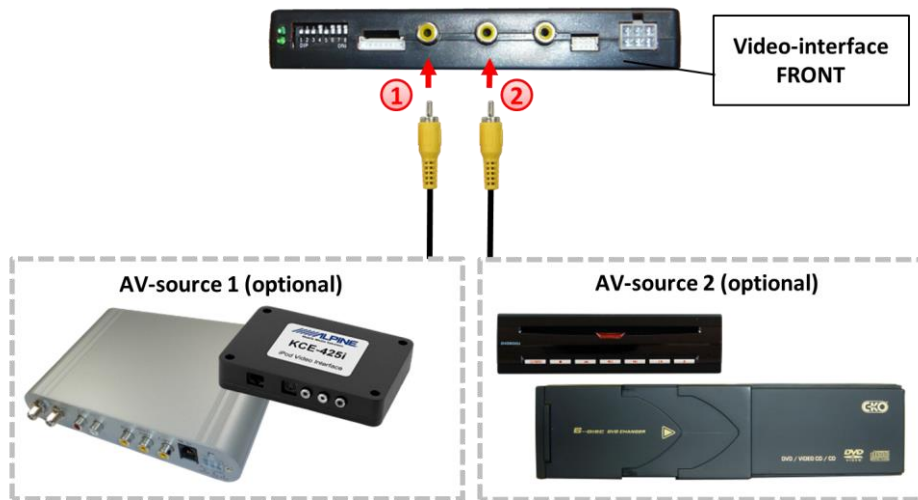

- ① Connect video RCA of the AV-source 1 to the female RCA connector IN1 of the video-interface.
- ② Connect video RCA of the AV-source 2 to the female RCA connector IN2 of the video-interface.

### 2.5.2. Audio-switch and audio insertion

This interface can only insert video signals into the factory infotainment. Audio insertion is possible by possibly existing factory audio AUX input or FM-modulator. The inserted video-signal can be activated parallel to each audio-mode of the factory infotainment. It is possible to switch the audio signals from the to IN1 and IN2 connected AV-sources parallel to the video-signal of the respective AV-source by video-interface's built-in audio-switch.

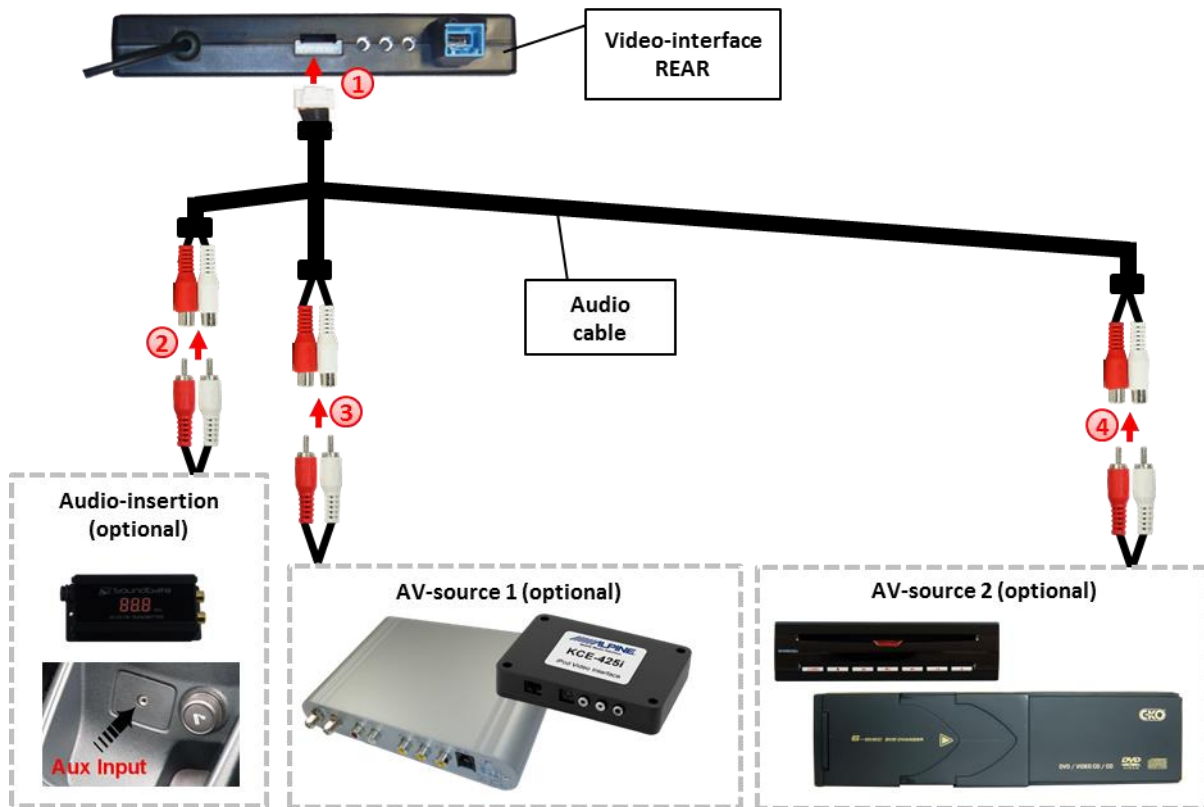

**Note:** If only one AV-source shall be connected, it is possible to connect the video output of the AV-source to video IN1 of the video-interface and the audio output of the AV-source direct to the audio-insertion.

- ① Connect female 8pin connector of the audio cable to male 8pin connector of the video-interface.
- ② Connect the audio-RCA of the possibly existing factory AUX-input or the FM-modulator to the female RCA port AV-Out of the audio cable.
- ③ Connect the audio-RCA of the AV-source 1 to the female RCA port AV1 of the audio cable.
- ④ Connect the audio-RCA of the AV-source 2 to the female RCA port AV2 of the audio cable.

Audio pins	Definition
1/2	Audio input signal R/L of source IN2
3/4	Audio input signal R/L of source IN1
5/6	Audio output signal R/L of factory audio AUX or FM-modulator
7	Ground
8	No function

**Note:** When switching the video interface from video-IN1 to video-IN2, the audio will also automatically be switched.

### 2.5.3. After-market rear-view camera

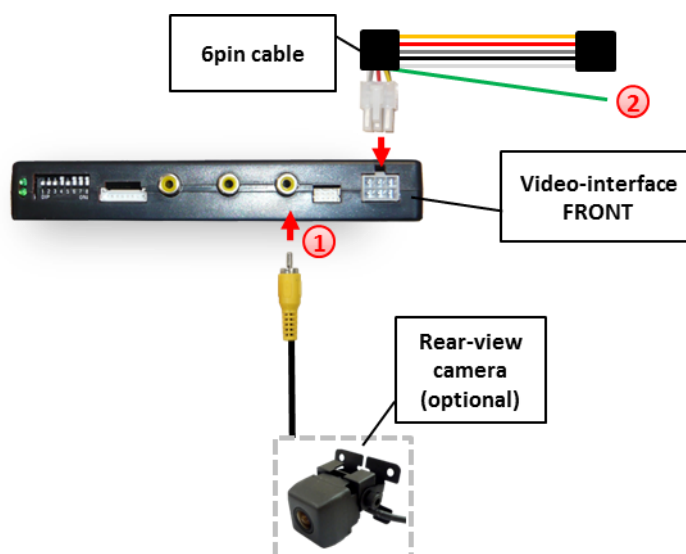

- ① Connect the video-RCA of the after-market rear-view camera to the female RCA port of the video-interface.
- ② If the GM-LAN-bus does not work while connecting an after-market rear-view camera, cut the green cable of the 6pin to 8pin cable at the black 8pin connector and connect it to the reverse gear light (+12V). For this use a relay because the reverse gear light of the vehicle is clocked (relay AC-RW1230 and AC-RS5 optional available).

**Note:** Set Dip 5 to ON.

2.5.4. After-market navigation

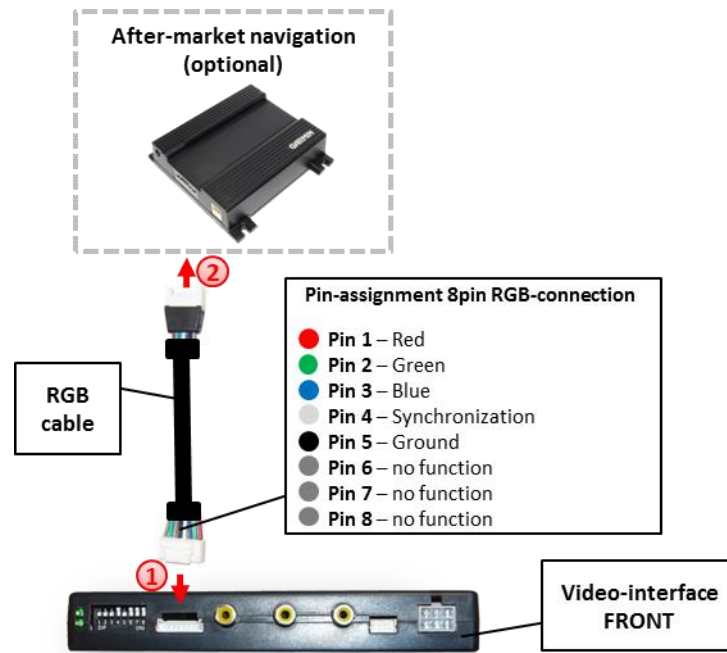

- ① Connect female 8pin connector of the RGB cable to the male 8pin connector of the video-interface. The loose grey wires have no function and have to be isolated.
- ② Connect male 6pin connector of the RGB cable to the after-Market navigation.

2.6. Connecting video-interface and keypad

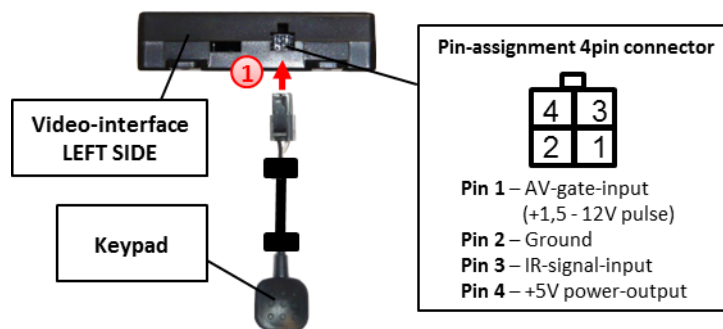

- ① Connect the female 4pin connector of the keypad to the male 4pin connector of the video-interface.

**Note:** We suggest to install the external push button, even if it is not going to be used by the user. Even if installed hidden, it is helpful for fault diagnosis.

## 2.7. Picture settings

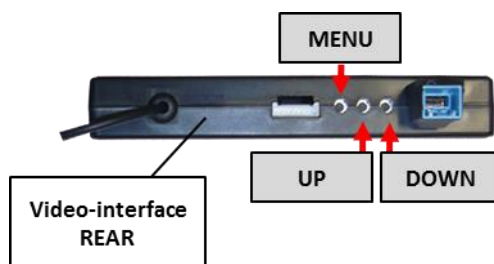

After installing the sources the picture settings can be changed using a pen on the buttons of the video interface. Press the MENU button to open settings menu on the OSD and to switch to the next setting. UP and DOWN change the corresponding values. The buttons are embedded in the housing to avoid accidental changes during or after installation.

The following settings are available:

- Brightness
- Contrast
- Saturation
- Position H (horizontal)
- Position V (vertical)

## 2.8. Activation of parking guide lines for rear-view camera

The parking guide lines for rear-view camera can be activated or deactivated via the OSD. Press the MENU button to open settings menu on the OSD and to switch to the next setting. Choose menu item "Guide Line" and activate (ON) or deactivate (OFF) parking guide lines by UP and DOWN buttons.

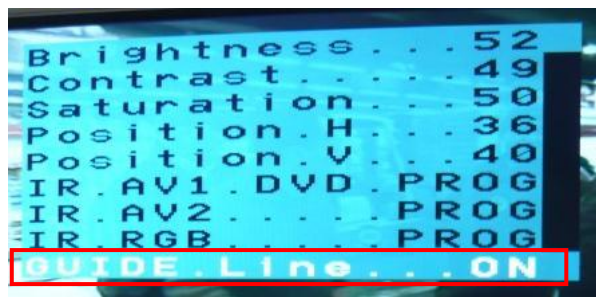

### 3. Interface operation

The “hang-up”-button on the steering-wheel and the interface’s keypad can be used to execute interface functions.

Press “hang-up”-button on the steering-wheel or short press keypad to switch the video-source.

Each repetition will switch to the next enabled input. If all inputs are enabled the order is:

*Factory video → RGB-in → video IN1 → video IN2 → factory video →...*

Inputs which are not enabled are skipped. If the audio cable is connected, when switching from video IN1 to video IN2, also the sound will be switched.

**Note:** The white wire of the 6pin cable can be used with a +5-12V pulse to switch the video-sources alternatively.

### 4. Specifications

BATT/ACC range	7V ~ 25V
Stand-by power drain	<5mA
Power	0.2A @12V
Power consumption	2.4W
Video input	0.7V~1V
Video input formats	PAL/NTSC
RGB-video amplitude	0.7V with 75 Ohm impedance
Temperature range	-40°C to +85°C
Weight	195g
Dimensions (box only) B x H x T	182 x 24 x 100 mm

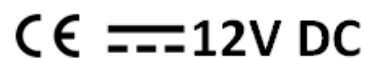

CE 12V DC

### 5. Connections (video-interface)

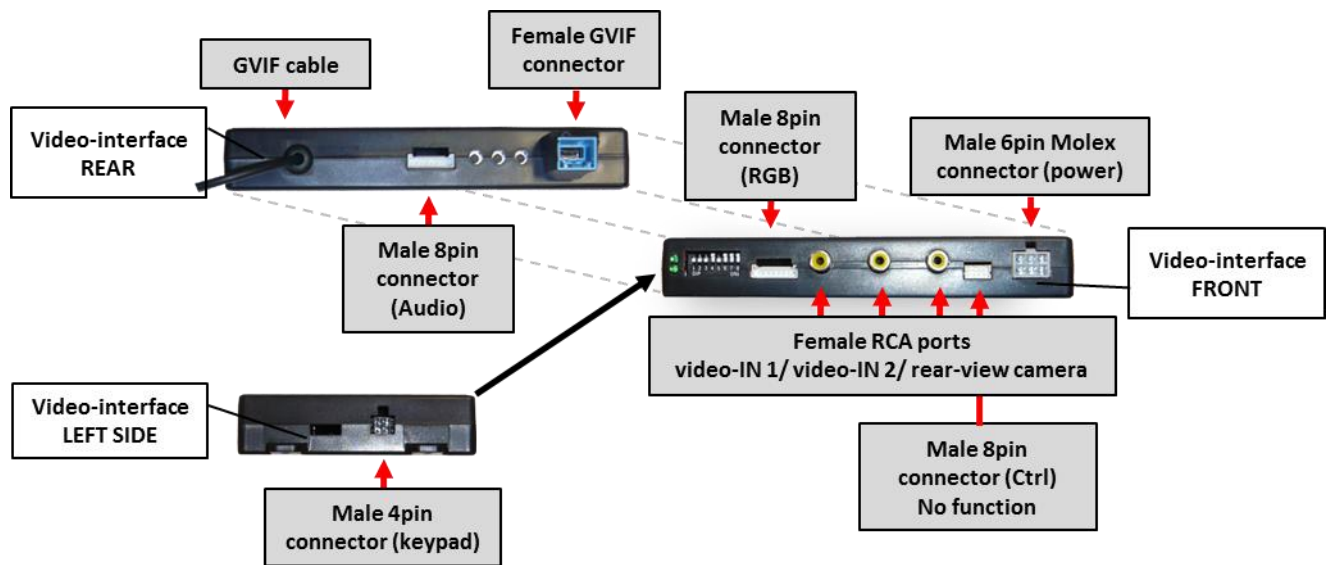

### 6. Technical Support

**NavLinkz GmbH**  
*distribution/tech dealer-support*  
 Eurotec-Ring 45  
 D-47445 Moers

**Caraudio-Systems Vertriebs GmbH**  
*distribution*  
 Rheinhorststr. 22  
 D-67071 Ludwigshafen am Rhein

Tel +49 180 3 907050  
 Email mail@navlinkz.de