

v.LiNK Video-inserter

VL2-MMI3G-Q3

VL2-MMI3G-GW

**Compatible with
Audi MMI3G basic/high, MMI3G+ basic/high and
VW RNS850 navigation systems
with 4pin HSD LVDS connector**

Video-inserter with 2 video + RGB + rear-view camera input

***ATTENTION! The interface is installed
on the backside of the head-unit,
not on the monitor!!!***

Product features

- **Video-inserter**
- **2 CVBS video-inputs for after-market devices (e.g. DVD-Player, DVB-T tuner, ...)**
- **Built-in audio-switch (no audio-insertion)**
- **Rear-view camera CVBS video-input**
- **Automatic switching to rear-view camera input on engagement of reverse gear**
- **RGB-input for after-market navigation**
- **Video-in-motion (ONLY for connected video-sources)**
- **Compatible with factory rear-view camera**
- **AV-inputs PAL/NTSC compatible**

Contents

1. Prior to installation

- 1.1. Delivery contents
- 1.2. Checking the compatibility of vehicle and accessories
- 1.3. Boxes and connectors
 - 1.3.1. CAN-box
 - 1.3.2. Video-Interface
 - 1.3.2.1. Dip-switch settings
 - 1.3.2.2. Enabling the interface's video inputs (dip 1-3)
 - 1.3.2.3. RGB-video input signal selection for after-market navigation (Dip 4)
 - 1.3.2.4. Rear-view camera setting (dip 5)
 - 1.3.2.5. Monitor selection (dip 7-8)
- 1.4. Dip-switch settings of CAN-box

2. Installation

- 2.1. Place of installation
- 2.2. Connection schema
- 2.3. Connecting video-interface and CAN-box
- 2.4. Connecting power and CAN-bus
 - 2.4.1. VL2-MMI3G-Q3 – Connection to the climate control panel and head-unit
 - 2.4.2. VL2-MMI3G-GW – Connection to the CAN-gateway
 - 2.4.3. RNS850 – Cable with open ends
- 2.5. Connection to the head-unit
- 2.6. Connecting peripheral devices
 - 2.6.1. After market RBG navigation
 - 2.6.2. Video-sources to AV1 and AV2
 - 2.6.3. Audio-switch and audio-insertion
 - 2.6.4. After-market rear-view camera
 - 2.6.4.1. Case 1: CAN-box detects reverse gear
 - 2.6.4.2. Case 2: CAN-box does not detect reverse gear
 - 2.6.4.3. Video signal connection
- 2.7. Connecting video-interface and keypad
- 2.8. Picture settings and guide lines

3. Interface operation

- 3.1. By factory infotainment buttons
- 3.2. By keypad

4. Specifications

5. Frequently asked questions

6. Technical support

Legal Information

By law, watching moving pictures while driving is prohibited, the driver must not be distracted. We do not accept any liability for material damage or personal injury resulting, directly or indirectly, from installation or operation of this product. This product should only be used while standing or to display fixed menus or rear-view-camera video when the vehicle is moving, for example the MP3 menu for DVD upgrades.

Changes/updates of the vehicle's software can cause malfunctions of the interface. We offer free software-updates for our interfaces for one year after purchase. To receive a free update, the interface must be sent in at own cost. Labor cost for and other expenses involved with the software-updates will not be refunded.

1. Prior to installation

Read the manual prior to installation.

Technical knowledge is necessary for installation. The place of installation must be free of moisture and away from heat sources.

1.1. Delivery contents (exemplary VL2-MMI3G-GW)

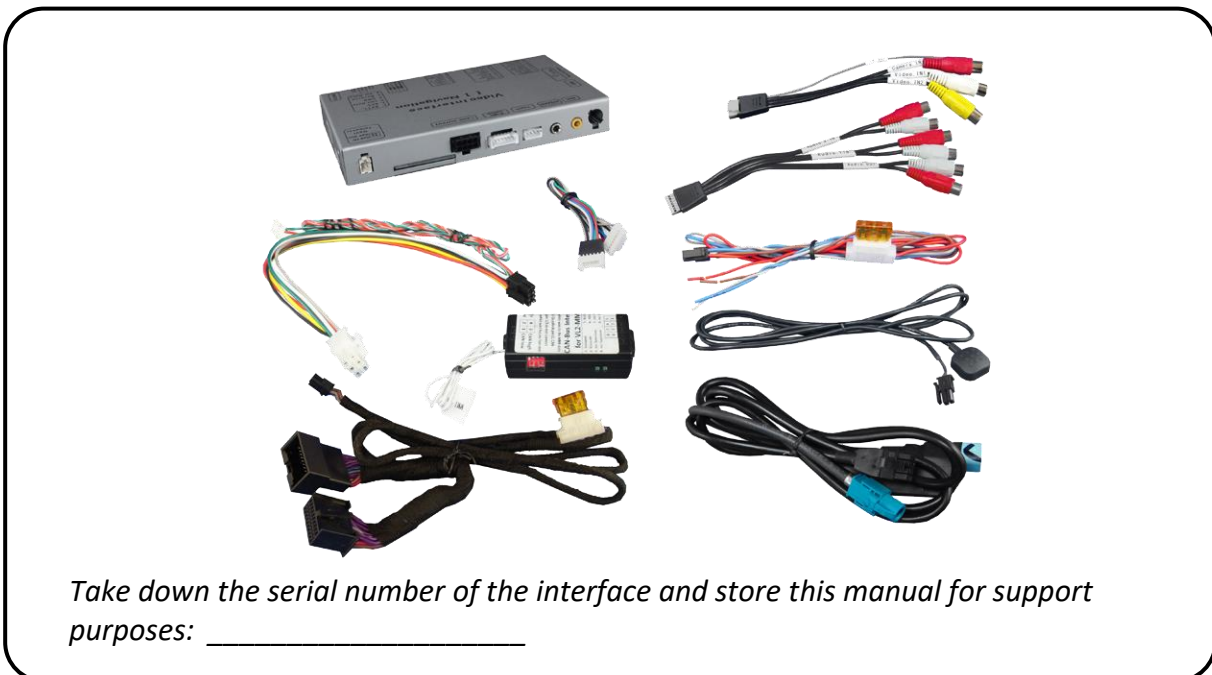

1.2. Checking the compatibility of vehicle and accessories

Requirements		
Vehicles	Navigation system (with 4pin HSD video connector)	Item no.
Audi Q3 (8U)	All head-units with monitor	VL2-MMI3G-Q3
Audi A1 (8X), Q7 (4L)	All head-units with monitor	VL2-MMI3G-GW
Audi A4 (8K, 8K allroad), A5 (8T), A6 (4F, 4F allroad), A6 (4G) till about 10/2014, A7 (4G), A8 (4E, 4H), Q5 (8R)	MMI3G, MMI3G+ basic/high	
VW Touareg from model year 2011	RNS850	

Limitations	
<i>Video only</i>	The interface inserts ONLY video into the infotainment. For sound use the possibly existing factory-audio-AUX-input, a FM-modulator or the AUX-in interface AUX-110.
<i>Factory OPS</i>	Display of an optical park display (OPS) isn't possible if an after-market rear-view camera is connected and reverse gear is engaged. Acoustic signals are still existing.
<i>Factory rear-view camera</i>	Automatic switch-back from inserted video to factory rear-view camera only while reverse gear is engaged. To delay the switch-back time, additional electronics is required.

1.3. Boxes and connectors

1.3.1. CAN-box

The CAN-box reads digital signals from the CAN-bus and converts them for the video-interface.

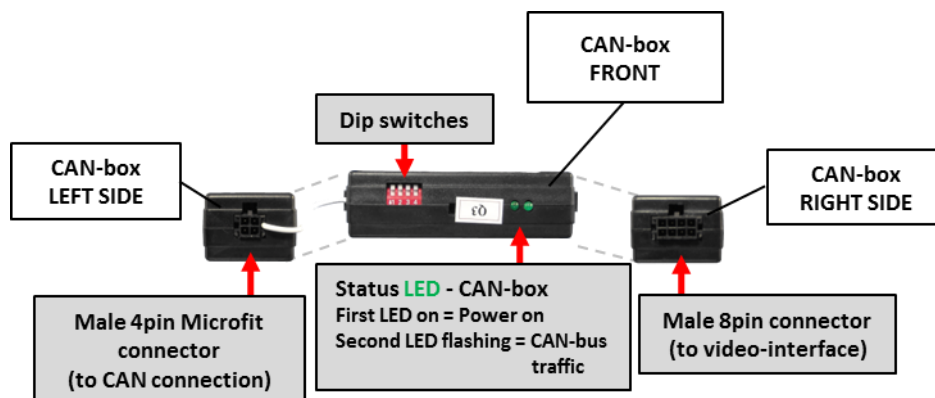

1.3.2. Video-interface

The video-interface converts the connected after-market sources video signals to an LVDS signal which is the inserted into the factory monitor on certain trigger options.

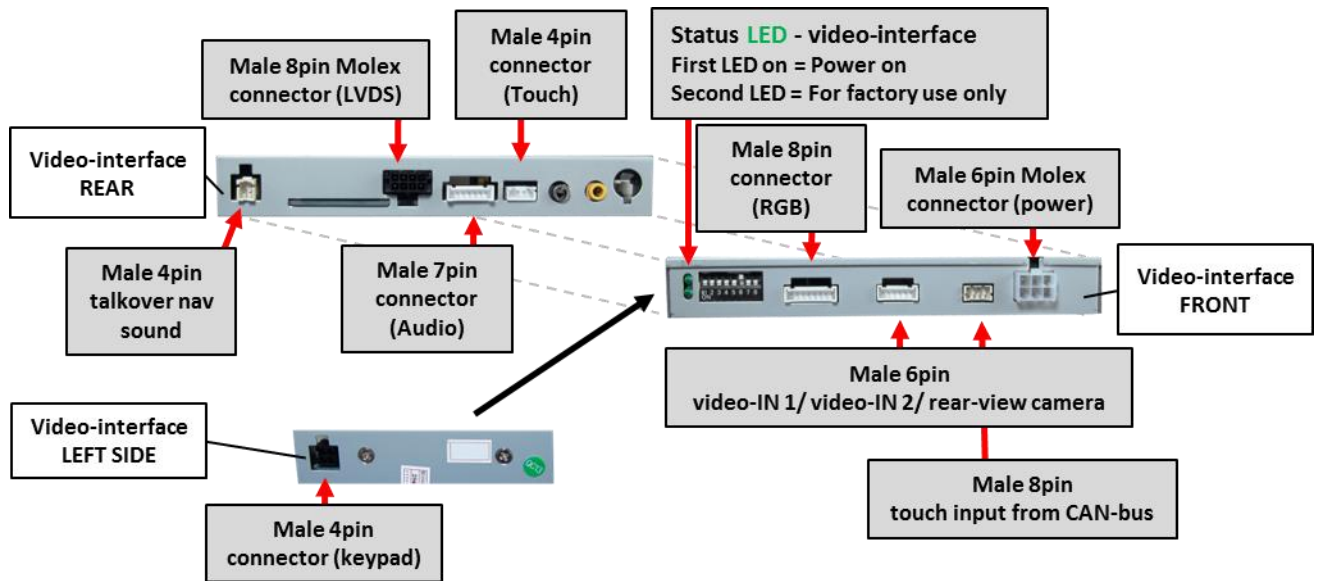

1.3.2.1. Dip-switch settings

Some settings must be selected by the dip-switches on the video-interface. Dip position down is ON and position up is OFF.



Dip	Function	ON (down)	OFF (up)
1	RGB-input	enabled	disabled
2	CVBS AV1-input	enabled	disabled
3	CVBS AV2-input	enabled	disabled
4	RGB-input resolution	VGA 800x480	RGB NTSC 400x240 or 480x240
5	Rear-view cam type	after-market	factory or none
6	No function	-	set OFF
7	Monitor selection	Try all 4 possible combinations of dip 7 and 8 to find the best picture (quality and size)	
8			

See following chapters for detailed information.

1.3.2.2. Enabling the interface's video inputs (dip 1-3)

Only the enabled video inputs can be accessed when switching through the interface's video sources. It is recommended to enable only the required inputs for the disabled will be skipped when switching through the video-interfaces inputs.

1.3.2.3. RGB-video input signal selection for after-market navigation (Dip 4)

If an after-market RGB navigation or other RGB video source is connected, the source's RGB output signal must match the interface's RGB video input setting.

1.3.2.4. Rear-view camera setting (dip 5)

If set to OFF, the interface switches to factory LVDS picture while the reverse gear is engaged to display factory rear-view camera or factory optical park system picture.

If set to ON, the interface switches to its rear-view camera input CAM while the reverse gear is engaged.

1.3.2.5. Monitor selection (dip 7-8)

Dip 7 and 8 are for monitor-specific video settings which cannot be predicted as even within the same head-unit version, the monitor specifications may vary. It is necessary to try all possible combinations (both OFF, both ON, 7 OFF and 8 ON, 7 ON and 8 OFF) - while a working video source is connected to the chosen input of the interface - to see which combination gives the best picture quality and size (some may give no picture). It is possible to first hot plug through the dip combinations, but if you do not experience any change of picture after trying all 4 options, retry and disconnected the 6pin power plug of the video-box between every change of the dip setting.

1.4. Dip-switch settings of CAN-box

Choose the navigation the interface is to be installed in and set dip 1 to 4 according to the below table.

ON ↓



Fahrzeug/Navigation	Dip 1	Dip 2	Dip 3	Dip 4
A1, A4, Q3	OFF	OFF	OFF	OFF
A6, Q7	ON	OFF	OFF	OFF

2. Installation

Switch off ignition and disconnect the vehicle's battery! The interface needs a permanent 12V source. If according to factory rules disconnecting the battery is to be avoided, it is usually sufficient to put the vehicle in sleep-mode. In case the sleep-mode does not show success, disconnect the battery with a resistor lead.

If power source is not taken directly from the battery, the connection has to be checked for being start-up proven and permanent.

2.1. Place of installation

The interface is installed on the backside of the head-unit (navigation computer/radio).

Depending on the version of the interface the connection to CAN-Bus and power is different:

Item no.	PNP cable CAN-bus/power
VL2-MMI3G-Q3	Climate control panel + head unit
VL2-MMI3G-GW	CAN-gateway
Special case RNS850: VL2-MMI3G-GW	Cable with open ends Climate control unit

2.2. Connection schema

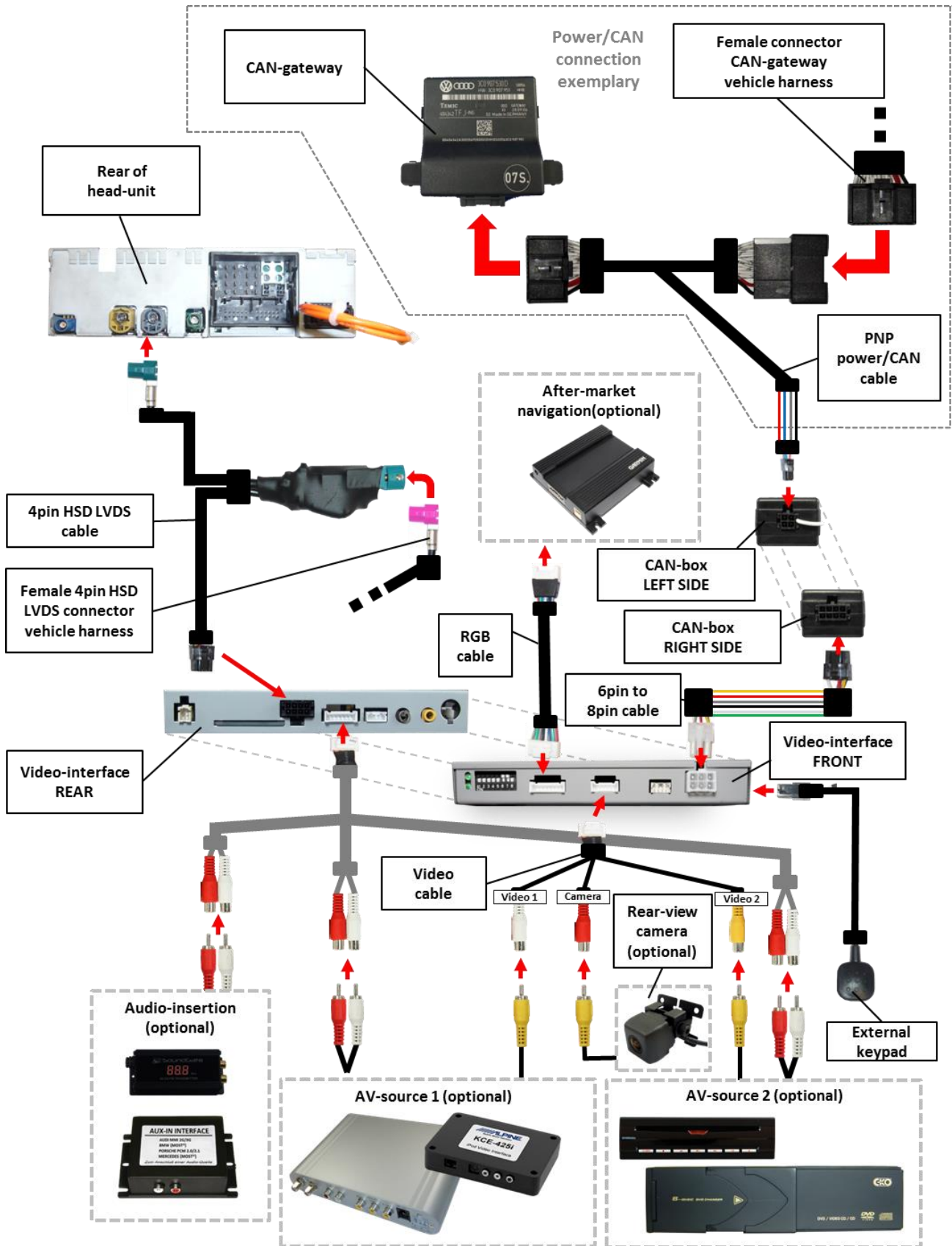

2.3. Connecting Video-interface and CAN-box

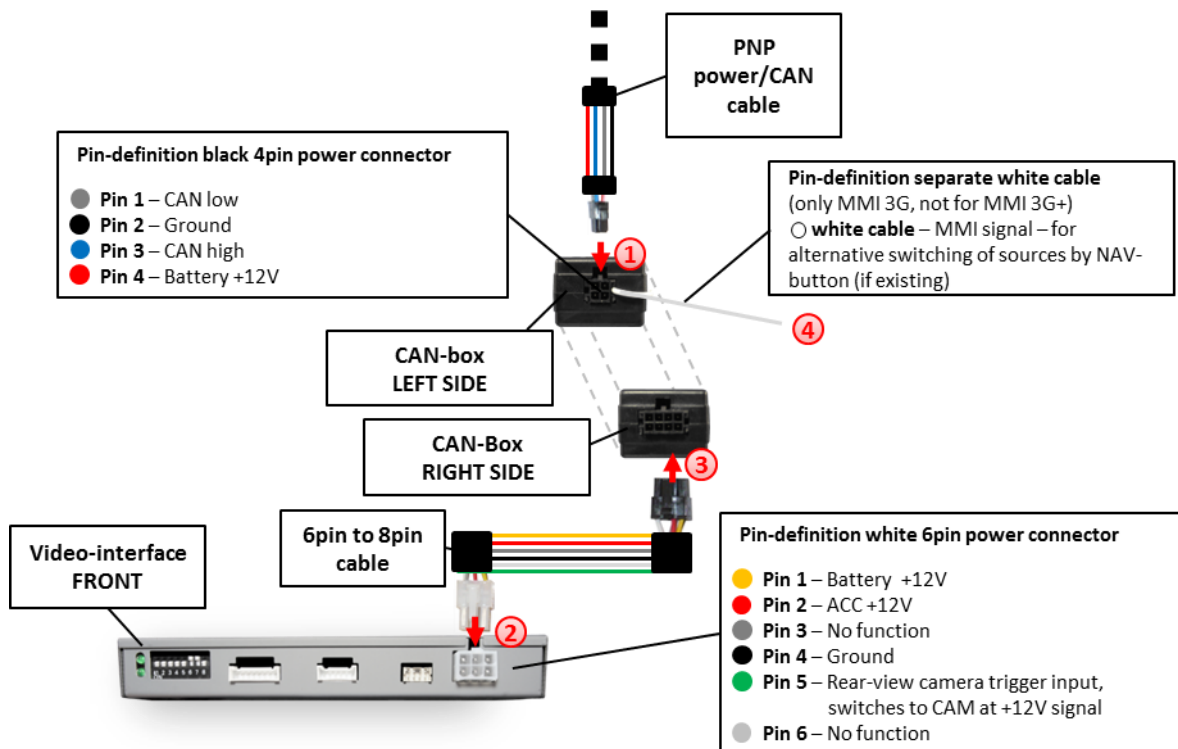

Note: It is possible to use the interface without MMI-box. In this case sort the female 8pin connector out from the 6pin to 8pin cable.

- ① Connect white female 4pin Micro-Fit connector of the PNP power/CAN cable to the male 4pin Micro-Fit connector of the CAN-box.
- ② Connect white female 6pin connector of the 6pin to 8pin cable to the male 6pin connector of the video-interface.
- ③ Connect black female 8pin Micro-Fit connector of the 6pin to 8pin cable to male 8pin Micro-Fit connector of the MMI-box.

Note: Check LEDs on video-interface after reconnecting the battery, one must be on.

- ④ Connect the separate white cable to MMI signal – only for alternative switching of sources by NAV button in the centre console, if existing. (only for MMI 3G, not for MMI 3G+ or RNS850).

2.4. Connecting power and CAN-bus

2.4.1. VL2-MMI3G-Q3 – Connection to the climate control panel and head-unit

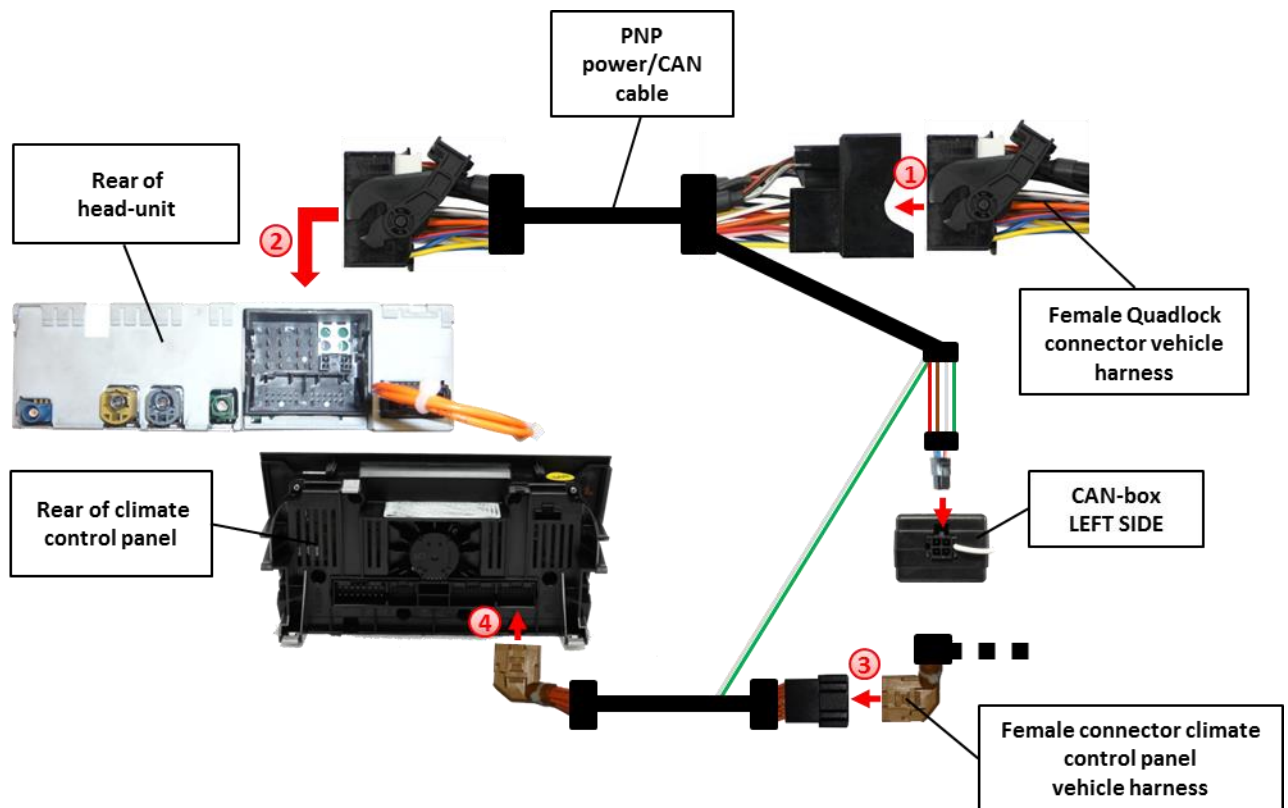

- ① Remove the female Quadlock connector of the vehicle harness from the rear of the Head-unit and connect it to the male Quadlock connector of the PNP power/CAN cable.
- ② Connect the female Quadlock connector of PNP power/CAN cable to the male Quadlock connector of the head-unit.
- ③ Remove the female connector of climate control panel of vehicle harness from the rear of climate control panel and connect it to the male connector of the PNP power/CAN cable.
- ④ Connect the female connector of PNP power/CAN cable to the male connector on the rear of climate control panel.

2.4.2. VL2-MMI3G-GW – Connection to the CAN-gateway

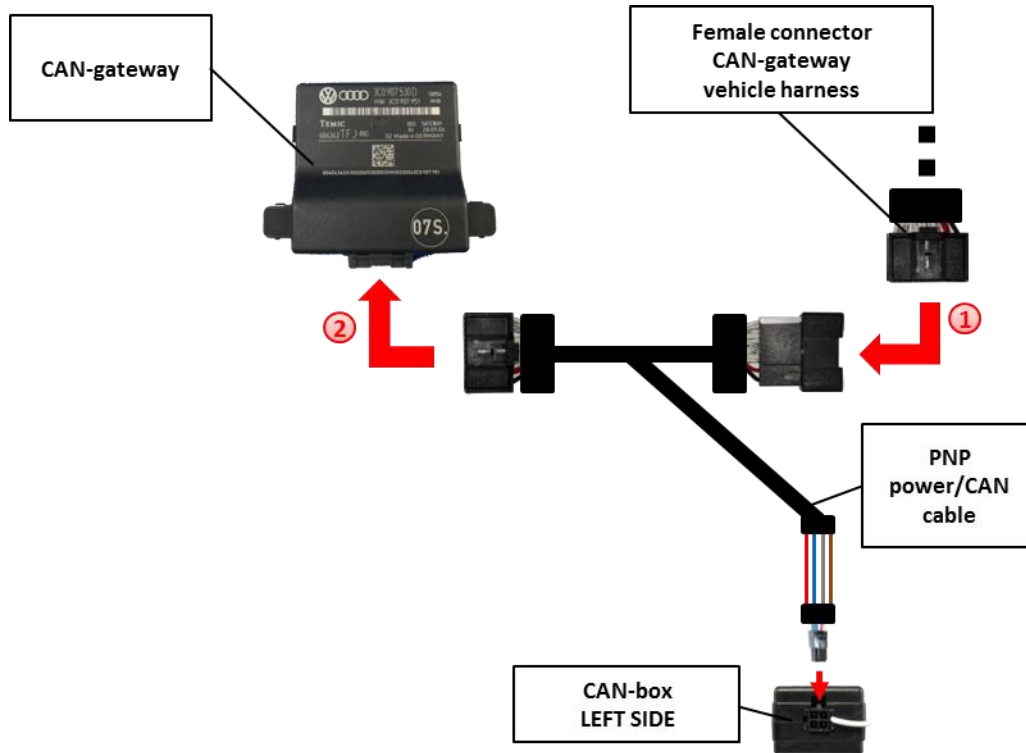

- ① Remove the female CAN-gateway connector of the vehicle harness from the rear of the CAN-gateway Head-unit and connect it to the male connector of the PNP power/CAN cable.

Pin diagram 4pin cable	Pin diagram CAN-gateway
<ul style="list-style-type: none"> CAN Low brown 	<ul style="list-style-type: none"> Pin 5 orange/grey Pin 6 orange/brown (Audi A6 vehicles)
<ul style="list-style-type: none"> CAN High blue 	<ul style="list-style-type: none"> Pin 15 orange/green Pin 22 orange/blue (Audi A6 vehicles)
<ul style="list-style-type: none"> Masse 	Pin 10 of the Quadlock!



Note: In case of difficulties with the connection of the PNP Power harness; the enclosed stripped 4pin harness can be soldered to the upper shown cables of the gateway. The 4pin cable diagram is shown below:

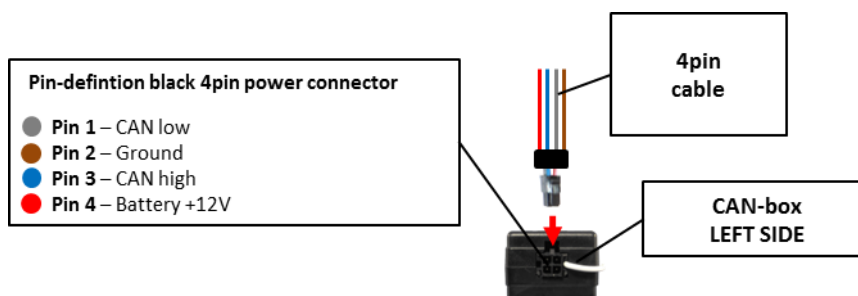

- ② Connect female connector of PNP power/CAN cable to the male connector of CAN-gateway.

Location of CAN-gateway

- A1/A3 below the steering-wheel
- A6/A7/A8 footwell on the passenger side below right (A6 from 2013 middle of rear bench seat)
- Q5/Q3 footwell on the passenger side top left

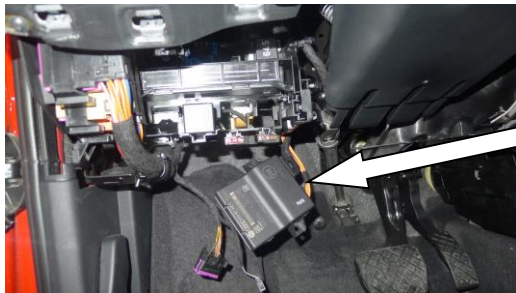

Location under the steering-wheel

2.4.3. RNS850 – Cable with open ends

For installation in VW vehicles with RNS850 use the additional 4-pin power cable with open ends. The PNP power/CAN cable isn't needed.

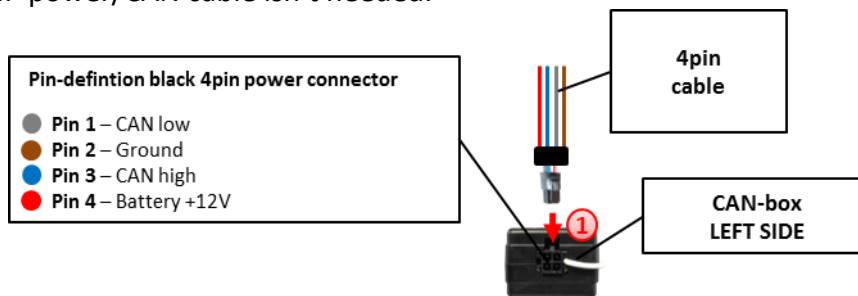

- ① Connect the stripped ends of the 4pin cable to ground, battery +12V, CAN high and CAN low of the climate control unit harness without cutting the cables of the vehicle harness.

The following pin diagram shows pins and cable colours:

Pin-diagramm 4pin cable	Pin diagram CAN-gateway
● grey CAN Low	● Pin 3 orange /brown
● blue CAN High	● Pin 2 orange/violett

There`s no liability for the vehicle`s pin diagram!

Changes in the manufacturer`s production are possible any time. The mentioned information has to be verified by the installer.

2.5. Connection to the head-unit

Remove head-unit (navigation computer/radio).

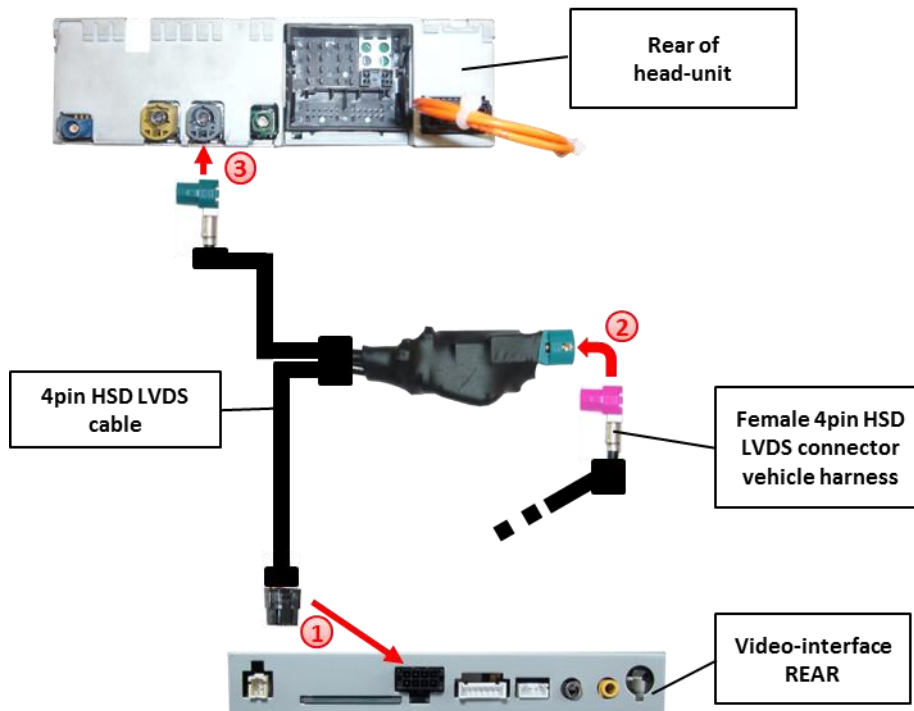

- ① Connect female 8pin Micro-Fit connector of the 4pin HSD LVDS cable to male 8pin Micro-Fit connector of the video-interface.
- ② Remove female 4pin HSD LVDS connector from the rear of the head-unit and connect it to the male 4pin HSD LVDS connector of the video-interface.

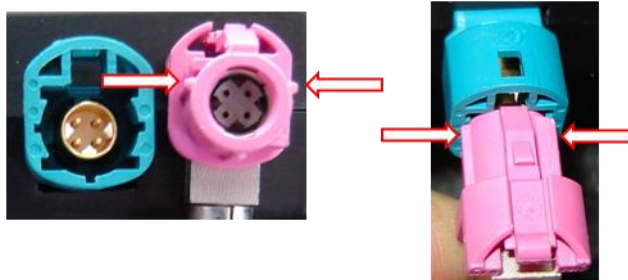

Note: The marked lug of the female 4pin HSD LVDS connector of the vehicle harness has to be cut off! Colour of the female 4pin HSD LVDS connector on vehicles with 8" monitor is grey.

- ③ Connect female 4pin connector of the HSD LVDS interface cable to the male 4pin HSD LVDS connector of the head-unit.

2.6. Connecting peripheral devices

It is possible to connect an after-market RGB navigation (or other RGB video source), 2 after-market AV-sources and an after-market rear-view camera to the video-interface.

Before final installation of the peripheral devices, we recommend a test-run of the interface. Due to changes in the production of the vehicle manufacturer is always the possibility of incompatibility.

2.6.1. After-Market RGB navigation

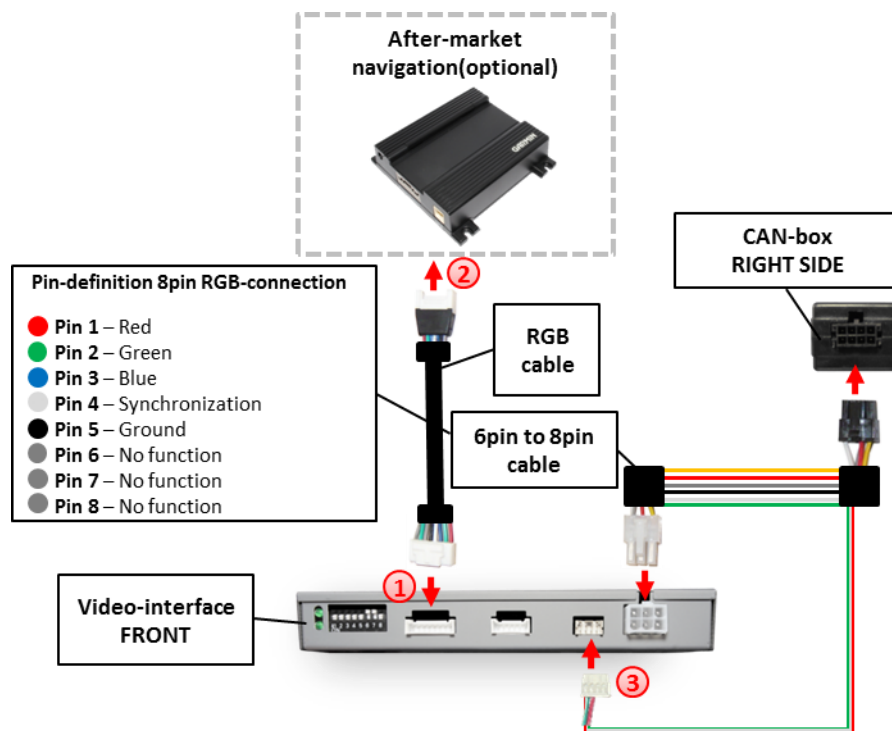

① Connect female 8pin connector of the RGB cable to the male 8pin connector of the video-interface. The loose grey wires have no function and have to be isolated.

② Connect male 6pin connector of the RGB cable to the after-Market navigation.

If connecting the after market navigation NAV-FN900D the factory touch-screen can be used. Please do the following step, too:

③ Connect female 8pin connector of 6pin to 8pin cable to 8pin connector (Ctrl) of the video-interface.

2.6.1. Video-sources to AV1 and AV2

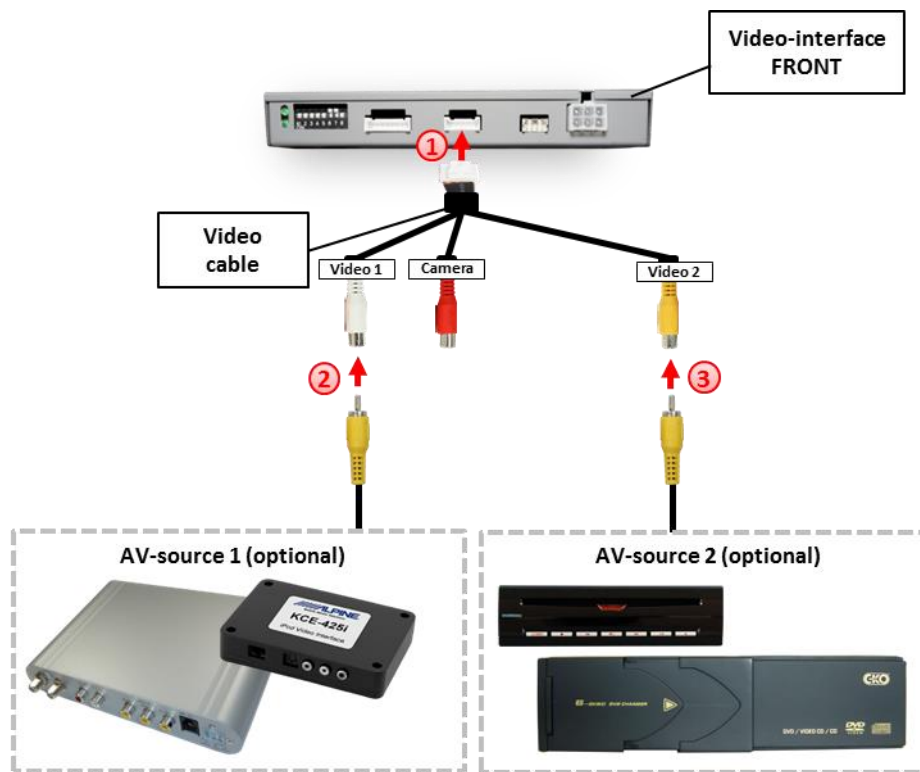

- ① Connect female 6pin connector of the audio cable to male 6pin connector of the video-interface.
- ② Connect video RCA of the AV-source 1 to the female RCA connector Video 1 of the video cable.
- ③ Connect video RCA of the AV-source 2 to the female RCA connector Video 2 of the video cable.

2.6.2. Audio-switch and audio insertion

This interface can only insert video signals into the factory infotainment and switch audio signals. If an AV-source is connected to AV1 or AV2, audio insertion must be done by factory audio AUX input, the optionally available AUX-in interface AUX-110 (only for MMI3G, not for MMI3G+) or FM-modulator to which the interface's sound-switch output is connected. When the interface is switched from AV1 to AV2, the audio signal is switched parallel to the corresponding video signal by the interface's built-in audio-switch. The inserted video-signal can be activated simultaneously to each audio-mode of the factory infotainment.

Note: If no factory AUX-input is available, it is possible to code it with the optionally available OBD-coder OBD-MMI3G-HM-xx.

Audio pins	Definition
1/2	Audio input signal R/L of source AV2
3/4	Audio input signal R/L of source AV1
5/6	Audio output signal R/L of factory audio AUX or FM-modulator
7	Ground

Note: If only one AV-source shall be connected, it is possible to connect the video output of the AV-source to the video input AV1 of the video-interface and the audio output of the AV-source directly to the point of audio-insertion (e.g. audio AUX input).

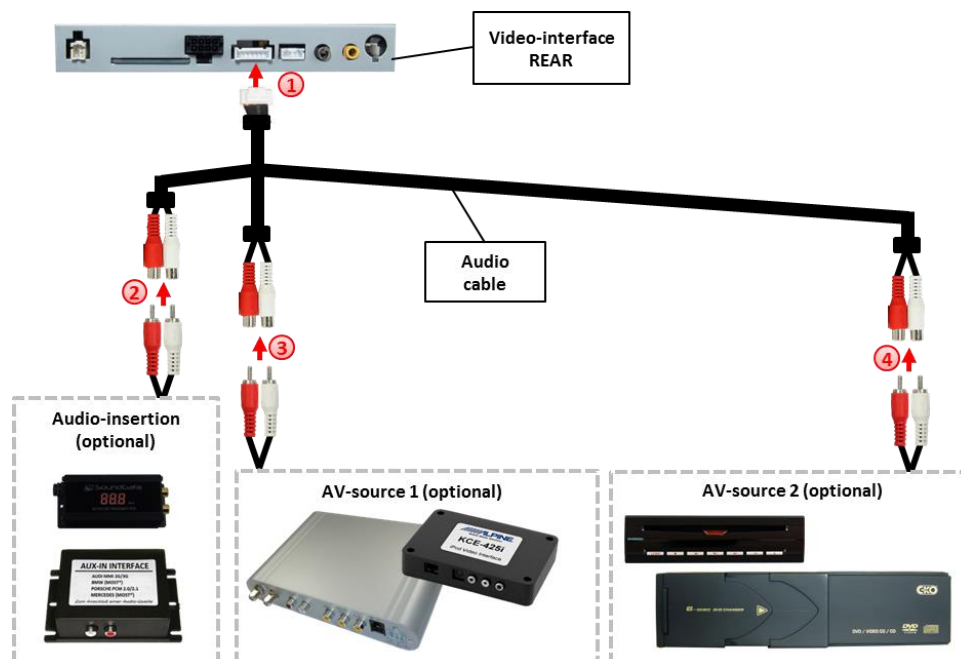

- ① Connect female 7pin connector of the audio cable to male 7pin connector of the video-interface.
- ② Connect the audio-RCA of the possibly existing factory AUX-input, the AUX-110 or the FM-modulator to the female RCA port AV-Out of the audio cable.
- ③ Connect the audio-RCA of the AV-source 1 to the female RCA port AV1 of the audio cable.
- ④ Connect the audio-RCA of the AV-source 2 to the female RCA port AV2 of the audio cable.

2.6.3. After-market rear-view camera

Some vehicles have a different reverse gear code on the CAN-bus which the included CAN-box is not compatible with. Therefore there is two different ways of installation. If the CAN-box can detect the reverse gear in the vehicle, the green wire of the 6pin to 8pin cable should carry +12V while the reverse gear is engaged.

Note: Do not forget to set dip5 of video-interface to ON before testing.

2.6.3.1. Case 1: CAN-box detects reverse gear

If the CAN-bus interface delivers +12V on the green wire of the 6pin to 8pin cable when reverse gear is engaged, the video interface will automatically be switched to the rear-view camera input CAM while reverse gear is engaged.

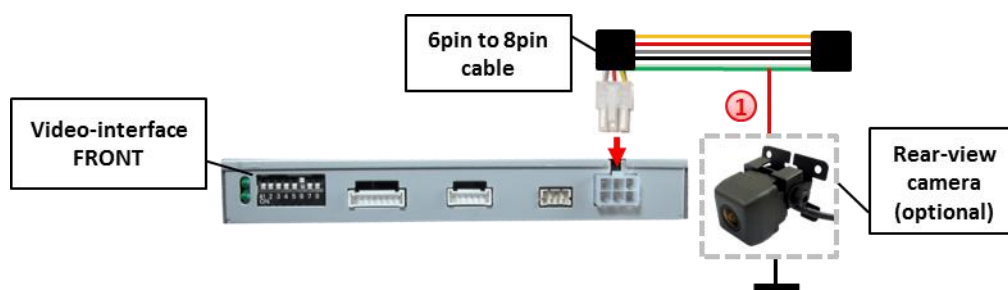

- ① Additionally, the +12V (max. 500mA) power supply for the rear-view camera can be taken from the green wire of the 6pin to 8pin cable.

2.6.3.2. Case 2: CAN-box does not detect reverse gear

If the CAN-bus interface does not deliver +12V on the green wire of the 6pin to 8pin cable when reverse gear is engaged (not all vehicles are compatible) an external switching signal from the reverse gear light is required. As the reverse gear light signal contains electronic interference, a normally open relay (e.g AC-RW-1230 with wiring AC-RS5) or filter (e.g. AC-PNF-RVC) is required. Below schema shows the use of a relay (normally open).

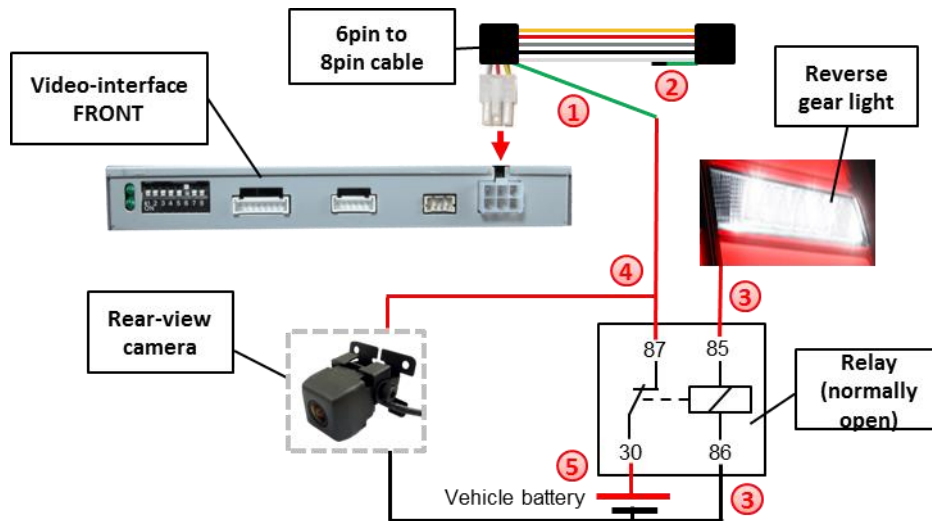

- ① Cut the green cable of the 6pin to 8pin cable close to the at the black 8pin connector.
- ② Isolate the short end of the green wire (CAN-box side).
- ③ Connect reverse gear light signal/power to coil (85) and ground to coil (86) of relais.
- ④ Connect rear-view camera power and green wire (video interface side) of 6pin to 8pin cable to output (87) of relay.
- ⑤ Connect permanent battery power to input (30) of relay.

2.6.3.3. Video signal connection

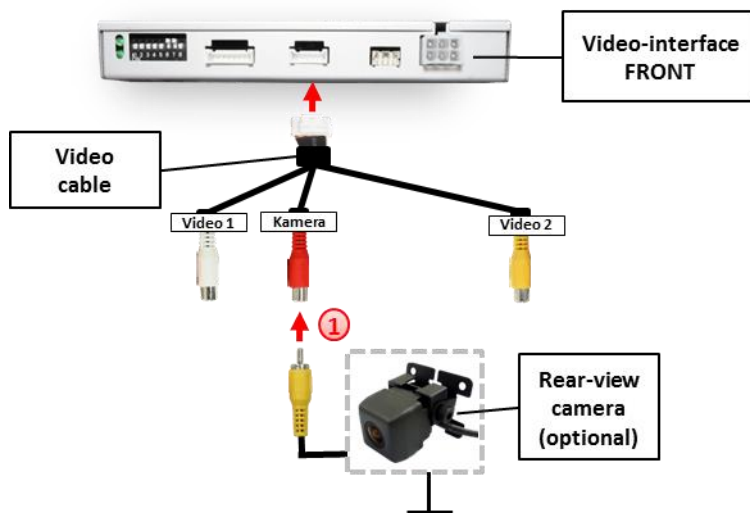

① Connect the video-RCA of the after-market rear-view camera to the female RCA port of the video-interface which is labeled as CAM.

Note: Picture settings for CAM input must be done in AV2.

2.7. Connecting video-interface and keypad

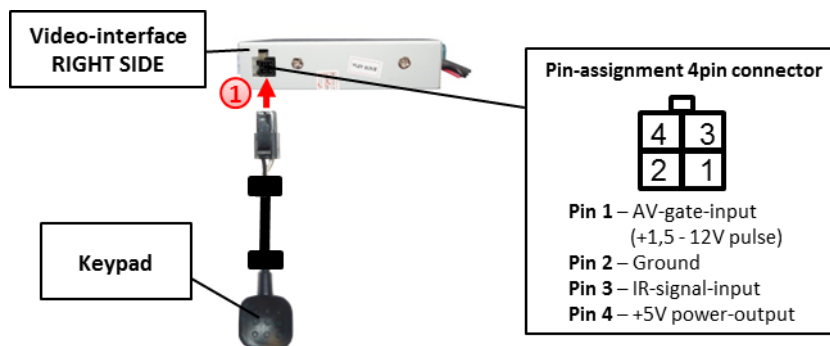

① Connect the female 4pin connector of the keypad to the male 4pin connector of the video-interface.

2.8. Picture settings and guide lines

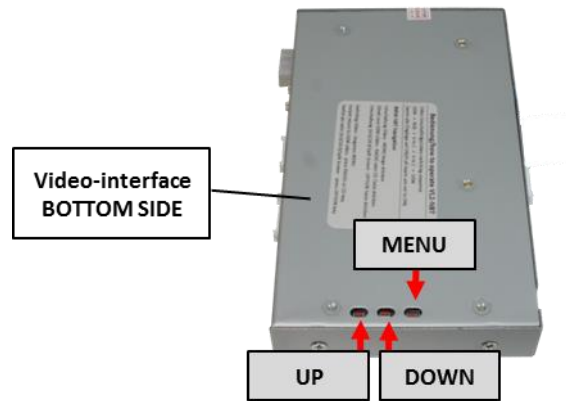

The picture settings are adjusted by the 3 buttons on the video-interface. Press the MENU button to open the OSD settings menu or to switch to the next menu item. Press UP and DOWN change the selected value. The buttons are embedded in the housing to avoid accidental changes during or after installation. Picture settings must be done separately for RGB, AV1 and AV2 while the corresponding input is selected and visible on the monitor. AV2 and CAM share the same settings which must be adjusted in AV2.

Note: The OSD menu is only shown when a working video source is connected to the selected video-input of the interface.

The following settings are available:

- Contrast
- Brightness
- Saturation
- Position H (horizontal)
- Position V (vertical)
- Guide-CNTRL (guide lines ON/OFF)

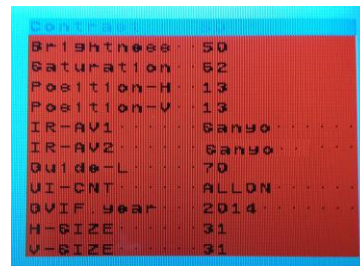

- GUIDE ON = guide lines activated
- PDC ON = PDC display activated aktiviert (only possible in some vehicles)
- ALL ON = guide lines and PDC display activated (PDC see above.)
- ALL OFF = guide lines and PDC display deactivated

Note: If the CAN-box does not support the very vehicle, the guide-lines cannot be used. PDC display function is only available in some vehicles.

3. Interface operation

3.1. By factory infotainment buttons

The **NAV** button and the **MODE** button of the **MMI** are used to execute interface functions.

MMI3G

Longpress **MODE** or **NAV** button to switch the video-source

MMI3G+ and A1 vehicles

Longpress **NAVI** button of the steering-wheel to switch the video-source.

Each press will switch to the next enabled input. If all inputs are enabled the order is:

Factory video → RGB-in → video IN1 → video IN2 → factory video →...

Inputs which are not enabled are skipped. If the sources are connected to the audio cable, when switching from video IN1 to video IN2, also the sound will be switched.

3.2. By keypad

Alternatively or additionally to the factory infotainment buttons the interface's external keypad can be used to switch the enabled inputs.

4. Specifications

BATT/ACC range	7V - 25V
Stand-by power drain	<5mA
Power	0.3A @12V
Video input	0.7V - 1V
RGB-Video amplitude	0.7V with 75 Ohm impedance
Temperature range	-40°C to +85°C
Video input formats	PAL/NTSC
Dimensions video-box	154 x 22 x 92 mm (W x H x D)
Dimensions CAN-box	73 x 22 x 30 mm (W x H x D)

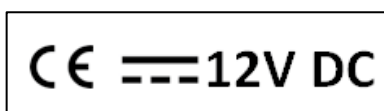

5. FAQ – Trouble shooting Interface functions

For any troubles which may occur, check the following table for a solution before requesting support from your vendor.

Symptom	Reason	Possible solution
No picture/black picture (factory picture).	Not all connectors have been reconnected to factory head-unit or monitor after installation.	Connect missing connectors.
	No power on CAN-bus box (all LED CAN-bus box are off).	Check power supply of CAN-bus box. Check CAN-bus connection of CAN-bus box.
	CAN-bus box connected to CAN-bus in wrong place.	Refer to the manual where to connected to the CAN-bus. If not mentioned, try another place to connect to the CAN-bus.
	No power on video-interface (all LED video-interface are off).	Check whether CAN-bus box delivers +12V ACC on red wire output of 8pin to 6pin cable. If not cut wire and supply ACC +12V directly to video-interface.
No picture/black picture/white picture (inserted picture) but factory picture is OK.	No picture from video source.	Check on other monitor whether video source is OK.
	No video-source connected to the selected interface input.	Check settings dips 1 to 3 of video interface which inputs are activated and switch to corresponding input(s).
	LVDS cables plugged in wrong place.	Double-check whether order of LVDS cables is exactly connected according to manual. Plugging into head-unit does not work when the manual says to plug into monitor and vice versa.
Inserted picture totally wrong size or position.	Wrong monitor settings of video-interface.	Try different combinations of dips 7 and 8 of video-interface. Unplug 6pin power after each change.
Inserted picture double or 4 times on monitor.		
Inserted picture distorted, flickering or running vertically.	Video sources output set to AUTO or MULTI which causes a conflict with the interfaces auto detection.	Set video source output fixed to PAL or NTSC. It is best to set all video sources to the same standard.
	If error occurs only after source switching: Connected sources are not set to the same TV standard.	Set all video sources to the same standard.
	Some interfaces can only handle NTSC input.	Check manual whether there is a limitation to NTSC mentioned. If yes, set source fixed to NTSC output.
Inserted picture b/w.	Picture settings have not been adjusted.	Use the 3 buttons and the interface's OSD to adjust the picture settings for the corresponding video input.
Inserted picture qual. bad.		
Inserted picture size slightly wrong.		
Inserted picture position wrong.		
Camera input picture flickers.	Camera is being tested under fluorescent light which shines directly into the camera.	Test camera under natural light outside the garage.
Camera input picture is bluish.	Protection sticker not removed from camera lens.	Remove protection sticker.

Symptom	Reason	Possible solution
Camera input picture black.	Camera power taken directly from reverse gear lamp.	Use relay or electronics to "clean" reverse gear lamp power. Alternatively, if CAN-bus box is compatible with the vehicle, camera power can be taken from green wire of 6pin to 8pin cable.
Camera input picture has distortion.		
Camera input picture settings cannot be adjusted.	Camera input picture settings can only be adjusted in AV2 mode.	Set dip 3 of video-interface to ON (if not input AV2 is not already activated) and connect the camera to AV2. Switch to AV2 and adjust settings. Reconnect camera to camera input and deactivate AV2 if not used for other source.
Graphics of a car in camera input picture.	Function PDC is ON in the interface OSD.	In compatible vehicles, the graphics will display the factory PDC distance. If not working or not wanted, set interface OSD menu item UI-CNTRL to ALLOFF.
Chinese signs in camera input picture	Function RET or ALL is ON (function for Asian market) in the interface OSD.	Set interface OSD menu item UI-CNTRL to ALLOFF or PDCON.
Not possible to switch video sources by OEM button.	CAN-bus interface does not support this function for vehicle.	Use external keypad or cut white wire of 6pin to 8pin cable and apply +12V impulses for AV-switching.
Not possible to switch video sources by external keypad.	Pressed too short.	For video source switching a longer press of about 2.5 seconds is required.
	SW-version of interface does not support external keypad.	Use OEM-button or cut white wire of 6pin to 8pin cable and apply +12V impulses for AV-switching.
Interface does not switch to camera input when reverse gear is engaged.	CAN-bus interface does not support this function for the vehicles.	Cut the green wire of the 6pin to 8pin cable and apply +12V constant from reverse gear-lamp signal. Use relay to "clean" gear lamp power.
Interface switches video-sources by itself.	CAN-bus interface compatibility to vehicle is limited.	Cut the grey wire of 6pin to 8pin and isolate both ends. If problem still occurs, additionally cut the white wire of 6pin to 8pin cable and isolate both ends.

6. Technical Support

Please note that direct technical support is only available for products purchased directly from NavLinkz GmbH. For products bought from other sources, contact your vendor for technical support.

NavLinkz GmbH
distribution/tech dealer-support
 Eurotec-Ring 39
 D-47445 Moers

Tel +49 2841 949970
 Email mail@navlinkz.de

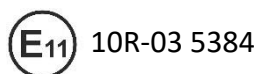

Made in China

