

VEGA

SUBWOOFER



1225 E. 7th St. • Los Angeles, CA 90021 USA
P 213-261-4161 • F 213-947-4767

WWW.CERWINVEGAMOBILE.COM



U82D/U84D/U102D/U104D
U122D/U124D/U152D/U154D

USER MANUAL

MAKING IT LOUD SINCE 1954!

Introduction

Cerwin Vega Mobile Subwoofers

Congratulations for purchasing a Cerwin Vega Mobile subwoofer for your car audio system. You have chosen Cerwin Vega Mobile because you deserve the best!

Cerwin Vega Mobile subwoofers are designed and engineered to reproduce extreme bass in your vehicle! Our authorized Cerwin Vega Mobile dealers can help guide you with various subwoofer applications and technical information in order to customize your sound system according to your own listening preference. It is highly recommended that you have your new subwoofer and enclosure installed by an authorized Cerwin Vega Mobile dealer to ensure that you receive the ultimate listening experience!

If you decide to install the subwoofer by yourself, please thoroughly read through this manual before getting started. This manual will help familiarize yourself with this subwoofer and guide you through the installation process and procedures with recommended enclosure designs for this particular product.

Please contact your local authorized Cerwin Vega Mobile dealer if you have any questions regarding the instructions in this manual or the subwoofer's application capabilities. If you require additional assistance, please contact the Cerwin Vega Mobile Technical Support Department during business hours at 213.261.4161

Warranty

Thank you for purchasing a Cerwin Vega Mobile product and we hope to provide you with countless hours of listening enjoyment.

Please take a brief moment to register your new product. By registering your new product, you will receive benefits such as:

- Important product notifications that may pertain to your purchase.
- Confirmation and record of ownership in case of loss or theft.
- Knowledgeable customer service and technical assistance pertaining to your product.

Register your new product by completely filling out this Product and Warranty Registration card or register online at www.cerwinvegamobile.com.

Registration is voluntary and failure to register will not diminish your limited warranty rights.

Limited Warranty (U.S.A.)

Cerwin Vega Mobile warrants all of our amplifiers and speakers to be free of defects in materials and workmanship for a period of one (1) year.

This warranty is non-transferable and applies only to the original purchaser from an authorized Cerwin Vega Mobile dealer. If service is required and necessary under this warranty due to manufacturing defect or malfunction, then Cerwin Vega Mobile will repair and/or replace defective product with either new or remanufactured like product at no charge at our discretion.

Damage to product caused by the following will not be covered under this warranty: abuse, accident, misuse, neglect, modifications, repairing attempts, seller/installer misrepresentation.

This warranty does not cover any incidental, consequential, or cosmetic damage due to accidents or normal wear and tear, nor does it cover the cost of removing or reinstallation of the product.

Warranty is void if the product's serial number has been removed, defaced, and/or tampered with.

Warranty Procedure:

We recommend that you contact your Cerwin Vega Mobile authorized dealer where your original purchase was made to initiate all warranty claims. Our authorized dealers can guide you through the warranty procedure to ensure that your claim will be processed in a timely manner. All warranty returns must be accompanied with a proof of purchase (a copy of the original sales receipt) and be shipped freight prepaid to our facility with an RA (Return Authorization) number clearly marked on the outside of the package. Direct returns from consumers or non-authorized dealers will be refused if shipped without a valid RA number authorized by Cerwin Vega Mobile beforehand.

INTERNATIONAL

Products purchased outside of the U.S.A. are covered only by that country's distributor and not by Cerwin Vega Mobile U.S.A.

Please Ship All Warranty Claims With Pre-Authorized RA Number To:
CV&DA Holdings, Inc.
ATTN: Customer Service Department
1225 E. 7th St.
Los Angeles, CA 90021 USA

Please Contact Customer Service for Further Warranty Information:
U.S.A.
Tel: 213-261-4161 / Fax: 213-947-4767

Specifications

Dimension	Unit	V82D/4D	V102D/4D	V122D/4D	V152/4D
Total Diameter (A)	in. (mm)	8.74" (222mm)	10.7" (272mm)	12.6" (320mm)	15.78" (401mm)
Mounting Diameter (B)	in. (mm)	7.08" (180mm)	8.82" (224mm)	10.7" (272mm)	13.62" (346mm)
Scerew Hole Dia. (C)	in. (mm)	? (?mm)	? (?mm)	? (?mm)	? (?mm)
Mounting Depth. (D)	in. (mm)	4.4" (112mm)	5.43" (138mm)	5.67" (144mm)	7.28" (185mm)
Magnet Dia. (E)	in. (mm)	4.64" (118mm)	5.63" (143mm)	6.53" (166mm)	7.08" (180mm)
Displacement (ft3/L)	in. (mm)	? (?mm)	? (?mm)	? (?mm)	? (?mm)

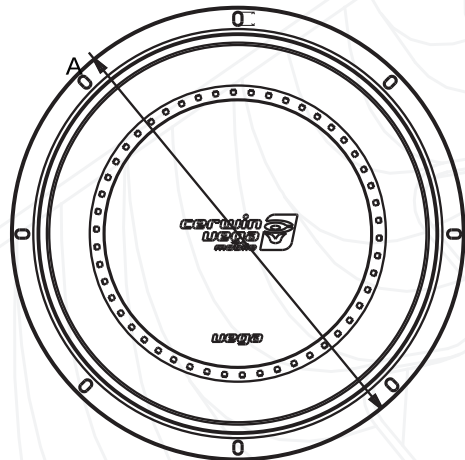
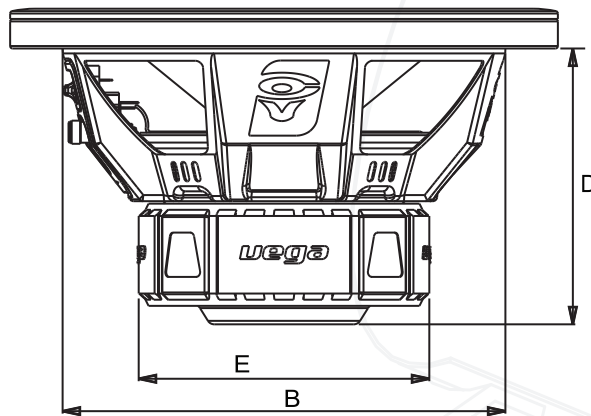

Thiele/Small Parameters

Parameter (unit)	V82D	VP84D	V102D	V104D	V122D	V124D	V152D	V154D
SPL (dB)	81.5	82	85	85.5	84.8	85.6	86.5	86.7
Re (Ω) [series]	2.0 / 2.0	4.0 / 4.0	2.0 / 2.0	4.0 / 4.0	2.0 / 2.0	4.0 / 4.0	2.0 / 2.0	4.0 / 4.0
Qms	7.2	6.8	6.9	6.1	11.4	8	7.3	9.5
Qes	0.7	0.76	0.5	0.66	0.68	0.71	0.58	0.74
Qts	0.63	0.597	0.469	0.602	0.643	0.653	0.542	0.69
Fs (Hz)	34.4	34.1	29.1	34.5	26.7	27.4	19.6	22.1
Vas (L)	14.9	14.6	39.6	28	67	62.3	244.9	166.8
Cms (mm/N)	0.262	0.241	0.257	0.37	0.197	0.42	0.268	0.32
Mms (g)	81.7	81.6	116.8	118	180.2	184.6	246.7	255.2
Sd (m ²)	0.02	0.02	0.033	0.033	0.049	0.049	0.08	0.08
BL (T*M)	9.9	12.8	6.4	15.3	13.1	16.6	15.1	18.5
Xmax (mm)	13.5	13.5	17	17	17	17.3	24	18.1
Pwr (W) NOM/MAX	250 / 500	250 / 500	400 / 800	400 / 800	450 / 900	450 / 900	550 / 1100	550 / 1100

Integrated Impedance Selector

To help installation we at Cerwin-Vega Mobile designed a simple but effective single terminal Dual Voice coil setup. Simple pull out the terminal rotate it to the impedance to the impedance desired. The impedance above the terminal is the impedance of the driver now, with only one set of speaker wires going to it. No complicated wiring anymore!!!

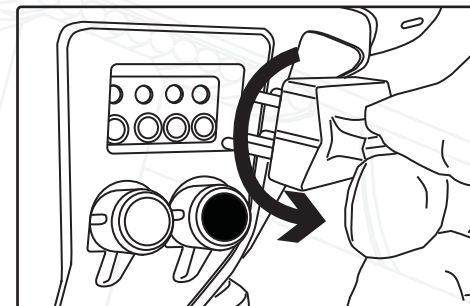

RECOMMENDED ENCLOSURES

(All measurements are calculated (Using 3/4" MDF))	Volume (net int.)	External Dimensions W _{Ext} x H _{Ext} x D _{Ext}	Volume (net int.)	Enclosure External Dimensions W _{Ext} x H _{Ext} x D _{Ext}	Slot Port Internal Dimensions P _{Port} W _{Port} x P _{Port} or H _{Port} x P _{Port} Length	Port Extension Length "PE"
V82/4D	0.5 ft ³ 14.9 litres	13.5" x 13.5" x 7.5" 343mm x 343mm x 215.59mm	0.75 ft ³ 21.23 litres	13.5" x 13.5" x 11.5" 343mm x 343mm x 292mm	1" x 10" x 22" 25.4mm x 254mm x 559mm	11.25" (285.75mm)
V102/4D	0.75 ft ³ 21.2 litres	14" x 12.75" x 10" 356mm x 324mm x 254mm	1.25 ft ³ 35.375 litres	20.5" x 13.5" x 13.25" 519mm x 305mm x 273mm	1.25" x 12" x 22" 32mm x 305mm x 559mm	10.75" (273mm)
V122/4D	1.25 ft ³ 35.4 litres	18" x 14.25" x 12.5" 457mm x 362mm x 317.5mm	1.50 ft ³ 42.450 litres	22" x 15" x 13.25" 559mm x 381mm x 273mm	1.625" x 13.5" x 27" 41mm x 343mm x 686mm	15.75" (400mm)
V152/4D	2.5 ft ³ 70.79 litres	18" x 18" x 18" 457mm x 457mm x 457mm	3.0 ft ³ 84.95 litres	18" x 18" x 21.5" 457mm x 457mm x 546mm	2.5" x 16.5" x 23" 63.5mm x 419.1mm x 584.2mm	9" (228")

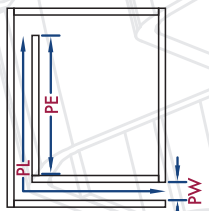
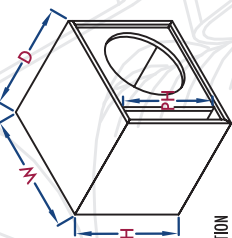
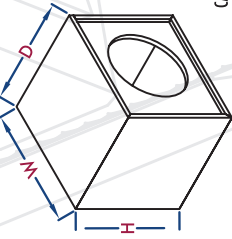
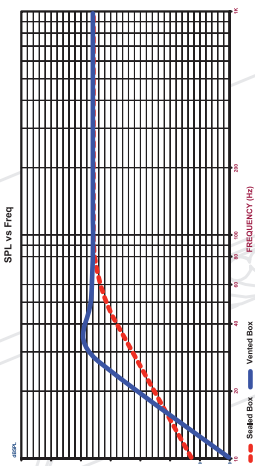

CAUTION
(The use of a sub-sonic filter set at a minimum of 30Hz is recommended on all vented enclosures.)



MINIMUM RMS POWER (50W BLACK AREA)
This lower amount of power will increase the longevity of the woofer, but will decrease the amount of output volume.

RECOMMENDED RMS POWER (100W GREEN AREA)
This is the optimum amount of power to provide the perfect balance output volume and woofer longevity.

MAXIMUM RMS POWER (250W RED AREA)
This is the maximum amount of power the woofer is designed to operate safely under. Only a moderate volume increase is gained (<1.7dB) at this higher power level. Operating beyond this power level will void your warranty.

Enclosures

Features

- V82D / V84D - 8 INCH SUBWOOFER
- V102D / V104D - 10 INCH SUBWOOFER
- V122D / V124D - 12 INCH SUBWOOFER
- V152 / VPRO154D - 15 INCH SUBWOOFER

- Proprietary Deep Drawn Stamped Cast Vega Basket
- Optimized High Power Motor Structure
- Parabolic One Piece Stamped Carbon Fiber Polypropylene Cone
- Vented Pole Piece For Additional Cooling For Extended Play
- Double Stitched VEGA RED Santoprene Surround
- Proprietary Horizontal Mounted Spring Loaded Terminal
- High Power Integrated Impedance Selector
- Vega Concealed Mounting Gasket

