



## INSTALLATION INSTRUCTIONS FOR PART 99-4644

### APPLICATIONS

See application list inside

# GM 1982-2005 99-4644

### KIT COMPONENTS

- A) Radio housing • B) Flat faceplate • C) 1/2" Faceplate • D) 1" Faceplate • E) Rear support tray
- F) ISO trimming • G) Bracket set #1 • H) Bracket set #2 • I) Bracket set #3 • J) Bracket set #4
- K) Bracket set #5 • L) Bracket set #6 • M) Bracket set #7 • N) Bracket set #8 • O) Bracket set #9
- P) Bracket set #10 • Q) ISO brackets • R) Bracket (L) S-10 • S) (4) Carriage bolts/studs
- T) (4) Nuts • U) (4) Hex-head screws

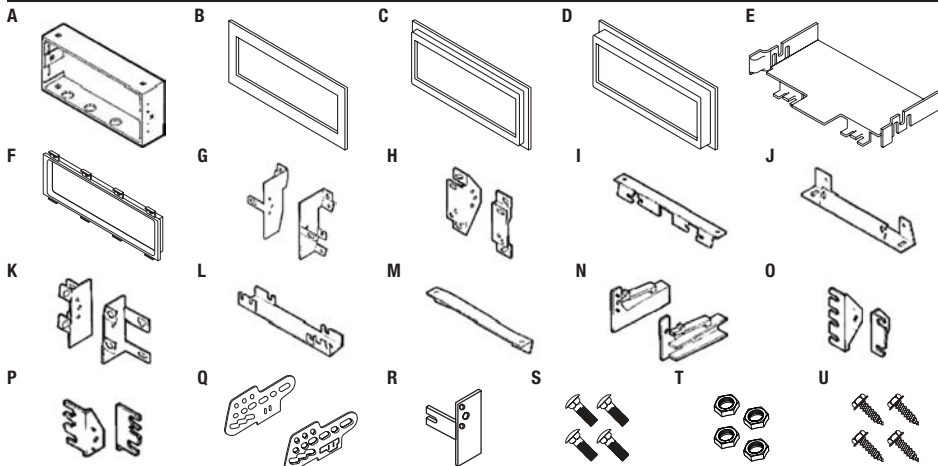

### KIT FEATURES

- DIN and ISO radio provisions
- *Also, for vehicles equipped with J-2000 panel-style*

### TOOLS REQUIRED

- Panel removal tool/flat head screwdriver
- Torx-head screwdriver • Socket wrench

**CAUTION:** Metra recommends disconnecting the negative battery terminal before beginning any installation. All accessories, switches, and especially air bag indicator lights must be plugged in before reconnecting the battery or cycling the ignition.

**NOTE:** Refer to the instructions included with the aftermarket radio.

REV 10/14/2014 INST99-4644

## Applications

### Buick

|               |           |
|---------------|-----------|
| Century*      | 1982-1996 |
| Electra*      | 1984-1990 |
| Estate Wagon* | 1984-1994 |
| LeSabre*      | 1984-1994 |
| Park Avenue*  | 1984-1994 |
| Reatta*       | 1990-1991 |
| Regal*        | 1984-1987 |
| Riviera*      | 1983-1985 |
| Riviera*      | 1990-1995 |
| Roadmaster    | 1991-1994 |
| Skyhawk*      | 1982-1989 |
| Skyllark*     | 1983-1995 |

### Cadillac

|            |           |
|------------|-----------|
| Cimarron   | 1982-1988 |
| DeVille*   | 1985-1995 |
| Eldorado*  | 1984-1991 |
| Escalade   | 1999-2002 |
| Fleetwood* | 1985-1992 |
| Seville*   | 1984-1991 |

### Chevrolet

|                |           |
|----------------|-----------|
| Astro          | 1985-2005 |
| Avalanche      | 2002      |
| Beretta        | 1991-1996 |
| Blazer (full)* | 1989-1991 |
| C/K Pickup     | 1995-2000 |
| Camaro         | 1982-1992 |
| Camaro         | 1997-2002 |
| Caprice        | 1991-1996 |
| Cavalier       | 1982-1999 |
| Celebrity*     | 1982-1990 |
| Citation II*   | 1985      |
| Corsica        | 1991-1996 |
| Corvette*      | 1984-1989 |
| Corvette       | 1997-2004 |
| El Camino      | 1986-1987 |
| Express        | 1996-2000 |
| G-Series Van   | 1988-1996 |
| Impala         | 1994-1996 |
| Lumina         | 1990-2001 |
| Lumina APV     | 1990-1996 |

### Chevrolet (continued)

|             |           |
|-------------|-----------|
| Malibu      | 1997-2000 |
| Monte Carlo | 1986-1988 |
| Monte Carlo | 1995-1999 |
| Nova        | 1985-1988 |
| S-10 Blazer | 1982-1994 |
| S-10 Blazer | 1998-2001 |
| S-10 Pickup | 1982-1993 |
| S-10 Pickup | 1998-2001 |
| Silverado   | 1999-2002 |
| Suburban*   | 1989-1991 |
| Suburban    | 1995-2002 |
| Tahoe       | 1995-2002 |
| Venture     | 1997-1999 |

### GMC

|               |           |
|---------------|-----------|
| C/K Pickup    | 1995-2000 |
| G-Series Van  | 1988-1995 |
| Jimmy (full)* | 1989-1991 |
| S-15 Jimmy    | 1998-2001 |
| S-15 Jimmy    | 1982-1994 |

### GMC (continued)

|             |           |
|-------------|-----------|
| S-15 Pickup | 1982-1990 |
| Safari      | 1985-2005 |
| Savana      | 1996-2000 |
| Sierra      | 1999-2002 |
| Sonoma      | 1991-1993 |
| Sonoma      | 1998-2001 |
| Suburban*   | 1989-1991 |
| Suburban    | 1995-1999 |
| Yukon       | 1995-2002 |

### Isuzu

|        |           |
|--------|-----------|
| Hombre | 1998-2001 |
|--------|-----------|

### Oldsmobile

|                  |           |
|------------------|-----------|
| Achieva*         | 1992-1995 |
| Bravada          | 1991-1994 |
| Cutlass Calais*  | 1984-1991 |
| Cutlass Ciera*   | 1982-1996 |
| Cutlass Supreme* | 1984-1988 |
| Delta 88*        | 1986-1988 |
| Firenza*         | 1982-1988 |

### Oldsmobile (continued)

|               |           |
|---------------|-----------|
| Ninety-Eight* | 1984-1990 |
| Omega         | 1983-1984 |
| Silhouette    | 1990-1999 |
| Toronado      | 1982-1985 |

### Pontiac

|             |           |
|-------------|-----------|
| 6000        | 1982-1991 |
| Bonneville* | 1982-1999 |
| Fiero*      | 1984-1988 |
| Firebird    | 1982-2002 |
| Grand Am*   | 1985-1995 |
| Grand Am    | 1996-2000 |
| Grand Prix* | 1985-1987 |
| Grand Prix  | 1990-2003 |
| Montana     | 1999      |
| Sunbird**   | 1982-1988 |
| Sunfire     | 1995-1999 |
| TransPort   | 1990-1998 |

### Saturn

|              |           |
|--------------|-----------|
| (all models) | 1991-1994 |
|--------------|-----------|

\* **Note:** The factory mounting bracket(s) must be retained and used with this vehicle.

\*\* **Note:** Vehicles are equipped with J-2000 panel style factory radios.

## Table of Contents

### Dash Disassembly

|  |    |   |    |
|--|----|---|----|
| - Buick Century 1982-1996 .....  | 5  | - Chevrolet Blazer (full size)/Suburban/GMC Jimmy (full size)/Suburban 1989-1991 .....  | 11 |
| - Buick Electra 1984-1990, Buick Estate Wagon/LeSabre/Park Avenue 1984-1994 .....  | 5  | - Chevrolet S-10 Blazer/S-10 Pickup 1998-2001, GMC S-15 Jimmy/<br>Sonoma 1998-2001, Isuzu Hombre 1998-2001 .....                    | 11 |
| - Buick Reatta 1990-1991 .....   | 5  | - Chevrolet Camaro/Pontiac Firebird 1982-1984 .....   | 12 |
| - Buick Regal 1984-1987 .....  | 6  | - Chevrolet Camaro/Pontiac Firebird 1985-1992 .....   | 12 |
| - Buick Riviera 1983-1985 .....  | 6  | - Chevrolet Camaro 1997-2002 .....  | 12 |
| - Buick Riviera 1990-1995 .....  | 6  | - Chevrolet Caprice/Impala 1994-1996 .....  | 13 |
| - Buick Roadmaster 1991-1994/Chevrolet Caprice 1991-1993 .....   | 7  | - Chevrolet Cavalier 1982-1990/Cadillac Cimarron 1982-1988<br>Pontiac Sunbird with J-2000 panel style factory radio 1982-1988 ..... | 13 |
| - Buick Syhawk 1982-1989/Oldsmobile Firenza 1982-1988 .....  | 7  | - Chevrolet Cavalier 1991-1994 .....  | 14 |
| - Buick Skylark 1983-1986 .....  | 8  | - Chevrolet Cavalier 1995-1999 .....  | 14 |
| - Buick Skylark 1987-1989 .....  | 8  | - Chevrolet Celebrity 1982-1983 .....   | 15 |
| - Buick Skylark 1990-1995 .....  | 8  | - Chevrolet Celebrity 1984-1990 .....   | 15 |
| - Cadillac Deville 1985-1995/Fleetwood 1985-1992 .....   | 9  | - Chevrolet Citation II 1985 .....  | 16 |
| - Cadillac Eldorado/Seville 1984-1991 .....  | 9  | - Chevrolet Corvette 1984-1989 .....  | 16 |
| - Cadillac Escalade, Escalade EXT/Chevrolet Avalanche, C-K Pickup, Silverado,<br>Suburban, Tahoe/GMC C-K Pickup, Sierra, Suburban, Yukon 1995-2002 ..... | 9  | - Chevrolet Corvette 1997-2004 .....  | 16 |
| - Chevrolet Astro/GMC Safari 1985-1989 .....   | 10 | - Chevrolet El Camino 1986-1987, Monte Carlo 1986-1988 .....  | 17 |
| - Chevrolet Astro/GMC Safari 1990-1995 .....   | 10 | - Chevrolet Express/GMC Savana 1996-2000 .....  | 17 |
| - Chevrolet Astro/GMC Safari 1996-2005 .....   | 10 | - Chevrolet Lumina 1990-1994 .....  | 17 |
| - Chevrolet Beretta/Corsica 1991-1996 .....  | 11 |   |    |

## Table of Contents

|  |    |  |    |
|--|----|--|----|
| - Chevrolet Lumina 1995-2001/Monte Carlo 1995-1999.....  | 20 | - Pontiac Bonneville 1987-1993.....                      | 23 |
| - Chevrolet Lumina APV/Oldsmobile Silhouette/Pontiac TransSport 1990-1995.....   | 18 | - Pontiac Bonneville 1994-1999.....                      | 24 |
| - Chevrolet Lumina APV/Oldsmobile Silhouette/Pontiac TransSport 1996.....  | 18 | - Pontiac Fiero 1984-1988.....                           | 24 |
| - Chevrolet Malibu 1997-2000.....  | 18 | - Pontiac Firebird 1993-2002.....                        | 24 |
| - Chevrolet Nova 1985-1988.....  | 19 | - Pontiac Grand Am 1985-1991.....                        | 25 |
| - Chevrolet S-10 Pickup/S-10 Blazer/GMC S-15 Pickup/S-15 Jimmy 1982-1985.....  | 19 | - Pontiac Grand Am 1992-1995.....                        | 25 |
| - Chevrolet S-10 Pickup 1986-1993/S-10 Blazer 1986-1994<br>GMC S-15 Pickup 1986-1990/S-15 Jimmy 1986-1994/Sonoma 1991-1993,<br>Oldsmobile Bravada 1991-1994..... | 19 | - Pontiac Grand Am 1996-1998.....                        | 25 |
| - Chevrolet/GMC G-Series Van 1988-1996.....  | 20 | - Pontiac Grand Am 1999-2000.....                        | 26 |
| - Chevrolet Venture/Oldsmobile Silhouette 1997-1999,<br>Pontiac Montana 1999/Transport 1997-1998.....  | 20 | - Pontiac Grand Prix 1985-1987/Bonneville 1982-1986..... | 27 |
| - Oldsmobile Ninety-Eight 1984-1990/Delta 88 1986-1988.....  | 21 | - Pontiac Grand Prix 1990-1993.....                      | 26 |
| - Oldsmobile Achieva 1992-1995.....  | 21 | - Pontiac Grand Prix 1994-1996.....                      | 26 |
| - Oldsmobile Cutlass Calais 1984-1991.....   | 21 | - Pontiac Grand Prix 1997-2003.....                      | 27 |
| - Oldsmobile Cutlass Ciera 1982-1996.....  | 22 | - Pontiac Sunfire 1995-1999.....                         | 28 |
| - Oldsmobile Cutlass Supreme 1984-1988.....  | 22 | - Saturn (all models) 1991-1994.....                     | 28 |
| - Oldsmobile Omega 1983-1984.....  | 22 |  |    |
| - Oldsmobile Toronado 1982-1985.....   | 23 |  |    |
| - Pontiac 6000 1982-1991.....  | 23 |  |    |
|  |    | <b>Kit Assembly</b>                                      |    |
|  |    | - DIN radio provision.....                               | 29 |
|  |    | - ISO radio provision.....                               | 30 |

### **Buick Century 1982-1996**

1. Remove (4) screws from the top-inside edge of the dash trim bezel. (Figure A)
2. Remove (5) screws from both sides of the steering column.
3. Remove (3) Phillips screws securing the rocker switch housing and lift the housing out.
4. Remove the hardware securing the factory mounting brackets to the factory radio. (Figure B)
5. Remove and retain the brackets.

*Continue to kit assembly*

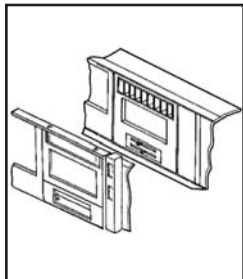

(Figure A)

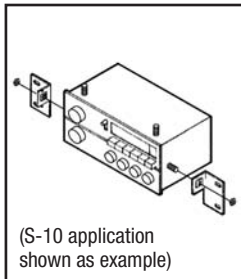

(Figure B)

### **Buick Electra 1984-1990 Buick Estate Wagon/ LeSabre/Park Avenue 1984-1994**

1. Unsnap the climate control trim bezel and remove (4) star-drive screws exposed. (Figure A)
2. Pull the steering collar back and carefully unsnap the dash trim bezel.
3. Remove the hardware securing the factory mounting brackets to the factory radio. (Figure B)
4. Remove and retain the brackets.

*Continue to kit assembly*

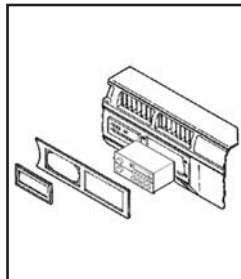

(Figure A)

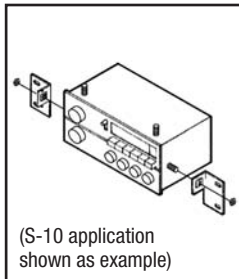

(Figure B)

### **Buick Reatta 1990-1991**

1. Remove (2) torx-head screws above the instrument panel. (Figure A)
2. Remove (1) torx-head screw from each A/C vent. (Figure A)
3. Unclip the dash trim bezel and remove.
4. Remove the hardware securing the factory mounting brackets to the factory radio. (Figure B)
5. Remove and retain the brackets.

*Continue to kit assembly*

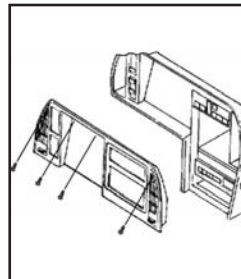

(Figure A)

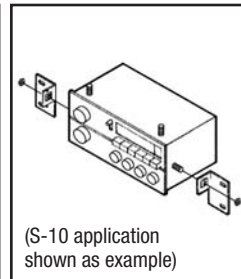

(Figure B)

### Buick Regal 1984-1987

1. Remove the radio knobs and cigarette lighter.
2. Gently unclip the radio trim bezel and remove. (Figure A)
3. Remove the hardware securing the factory mounting brackets to the factory radio. (Figure B)
4. Remove and retain the brackets.

*Continue to kit assembly*

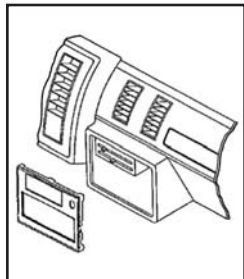

(Figure A)

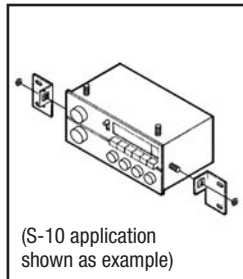

(Figure B)

### Buick Riviera 1983-1985

1. Carefully pull and remove the dash trim bezel. (Figure A)
2. Remove (4) screws securing the factory radio and disconnect the wiring. (Figure B)
3. Remove the hardware securing the factory mounting brackets to the factory radio. (Figure B)
4. Remove and retain the brackets.

*Continue to kit assembly*

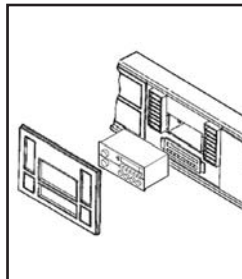

(Figure A)

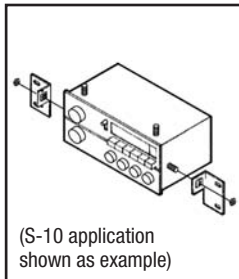

(Figure B)

### Buick Riviera 1990-1995

1. Remove (2) torx-head screws above the instrument panel. (Figure A)
2. Remove (1) torx-head screw from each A/C vent. (Figure A)
3. Unsnap the panel.
4. Remove the hardware securing the factory mounting brackets to the factory radio. (Figure B)
5. Remove and retain the brackets.

*Continue to kit assembly*

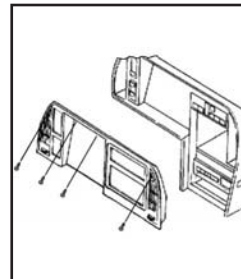

(Figure A)

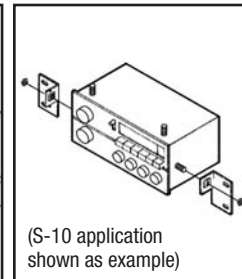

(Figure B)

## Buick Roadmaster 1991-1994 Chevrolet Caprice 1991-1993

1. Remove (2) screws from the driver's side service panel and unclip the panel.
2. Pry off the trim piece located above the glove box and remove (1) screw.
3. Remove (3) screws from the top edge of the dash trim bezel. (Figure A)
4. Remove (1) screw from the lower-left corner of the glove box and (1) screw from the parking brake release.
5. Remove the dash trim bezel.
6. Cut and remove all mounting tabs on Bracket #4 EXCEPT tabs "B". (Figure B)

**Note:** Identify mounting tabs by the stamped letter on the back of each tab.

*Continue to kit assembly*

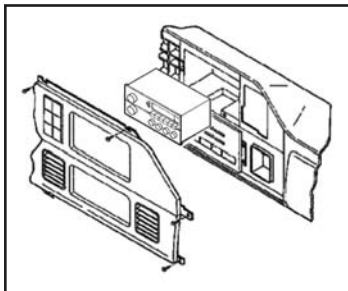

(Figure A)

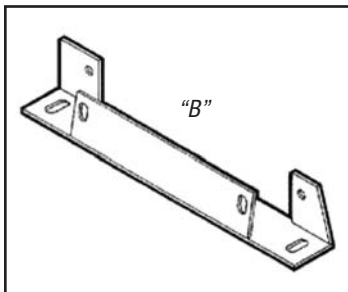

(Figure B)

## Buick Syhawk 1982-1989/Oldsmobile Firenza 1982-1988

1. Remove the glove box by removing the doorstrap wire clip and (4) screws. (Figure A)
2. Remove (2) screws below the cigarette lighter housing and (3) screws below the steering column. (Figure A)
3. Remove (1) screw from the top-left of the factory radio and unclip the dash trim bezel. (Figure A)
4. Remove the hardware securing the factory mounting brackets to the factory radio. (Figure B)
5. Remove and retain the brackets.

*Continue to kit assembly*

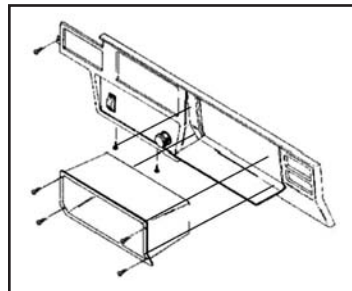

(Figure A)

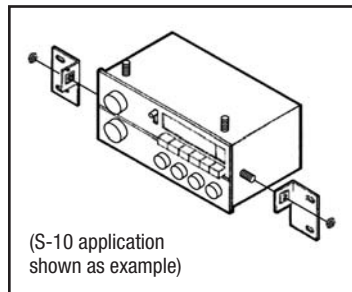

(S-10 application shown as example)

(Figure B)

### Buick Skylark 1983-1986

1. Remove (4) screws from the top edge of the instrument panel. (Figure A)
2. Remove (1) screw from the bottom-left corner of the panel. (Figure A)
3. Remove (2) screws from the steering column trim and remove the trim.
4. Pull up and out on the dash trim bezel and remove.
5. Remove the hardware securing the factory mounting brackets to the factory radio. (Figure B)
6. Remove and retain the brackets.

*Continue to kit assembly*

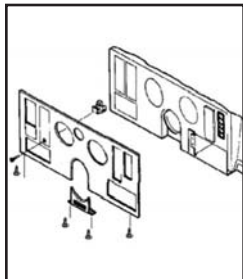

(Figure A)

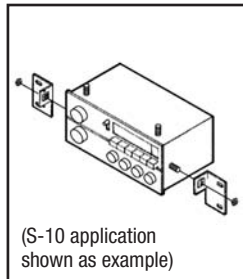

(Figure B)

### Buick Skylark 1987-1989

1. Unsnap the gear shifter bezel from the base of the console.
2. Remove (2) screws securing the bottom of the dash trim bezel and remove the bezel. (Figure A)
3. Remove the hardware securing the factory mounting brackets to the factory radio. (Figure B)
4. Remove and retain the brackets.

*Continue to kit assembly*

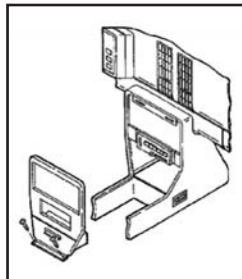

(Figure A)

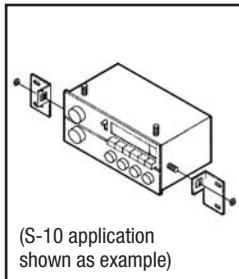

(Figure B)

### Buick Skylark 1990-1995

1. Pull out on the ashtray and remove (2) screws exposed in the ashtray cavity.
2. Remove (2) screws securing the front of the ashtray and lower section of the dash trim bezel. (Figure A)
3. Using a panel removal tool, gently pry out on the trim bezel and remove.
4. Remove (2) nuts from the bottom of the factory radio and disconnect the wiring.
5. Remove the hardware securing the factory mounting brackets to the factory radio. (Figure B)
6. Remove and retain the brackets.

*Continue to kit assembly*

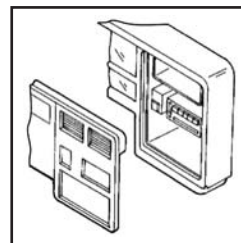

(Figure A)

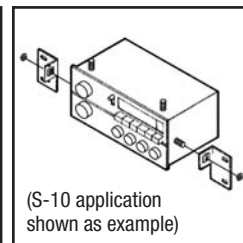

(Figure B)



### Cadillac Deville 1985-1995 Fleetwood 1985-1992

1. Remove (2) screws from the top of the radio trim bezel.
2. Pull out on the top edge of the bezel and lift up to remove. (Figure A)
3. Remove the hardware securing the factory mounting brackets to the factory radio. (Figure B)
4. Remove and retain the brackets.

*Continue to kit assembly*

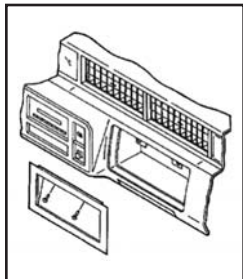

(Figure A)

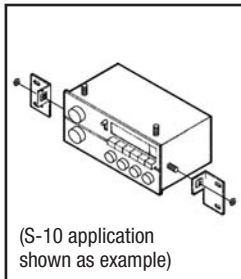

(Figure B)

### Cadillac Eldorado/Seville 1984-1991

1. Remove (2) Phillips screws above the A/C vents. (Figure A)
2. Pull out on the top edge of the dash trim bezel unhook the bottom edge and remove.
3. Remove the hardware securing the factory mounting brackets to the factory radio. (Figure B)
4. Remove and retain the brackets.

*Continue to kit assembly*

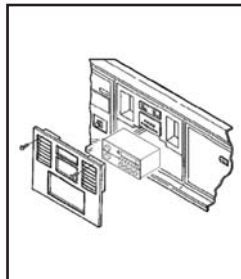

(Figure A)

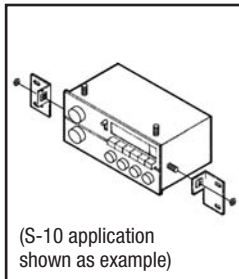

(Figure B)

### Cadillac Escalade, Escalade EXT/Chevrolet Avalanche, C-K Pickup, Silverado, Suburban, Tahoe/GMC C-K Pickup, Sierra, Suburban, Yukon 1995-2002

1. Remove the steering column filler panel and the ashtray. (Figure A)
2. Unclip the dash trim bezel and remove.
3. Using a small flat-blade screwdriver, press down on the outer clips of the factory radio (or pocket).
4. Disconnect the wiring and remove the radio. Locate Bracket Set #8. (Figure B)

*Continue to kit assembly*

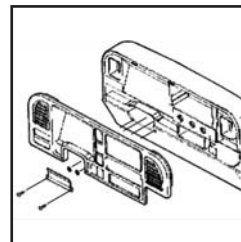

(Figure A)

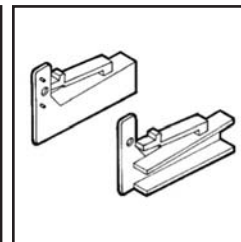

(Figure B)

## Chevrolet Astro/GMC Safari 1985-1989

1. Remove (3) Phillips screws from the top portion of the dash trim bezel. (Figure A)
2. Open the glove box and remove (2) 10mm bolts from the lower edge of the trim bezel. (Figure A)
3. Pull the console trim forward and remove (2) 7mm bolts exposed.
4. Gently unclip and remove the trim bezel. Remove (2) 7mm screws from the factory radio and disconnect the wiring.
5. Cut and remove all mounting tabs on Bracket #3 EXCEPT tabs "A". (Figure A)

**Note:** Identify mounting tabs by the stamped letter on the back of each tab.

Continue to kit assembly

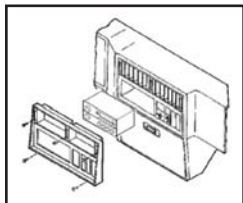

(Figure A)

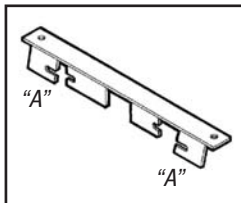

(Figure B)

## Chevrolet Astro/GMC Safari 1990-1995

1. Remove (2) screws from the bottom of the dash trim bezel. (Figure A)
2. Gently unclip and remove the bezel.
3. Remove (4) screws from the factory radio and disconnect the wiring.
4. Cut and remove all mounting tabs on Bracket #1 EXCEPT tabs "A". (Figure B)

**Note:** Identify mounting tabs by the stamped letter on the back of each tab.

Continue to kit assembly

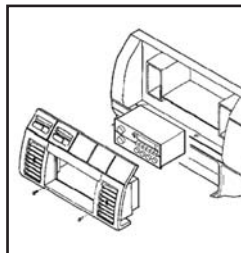

(Figure A)

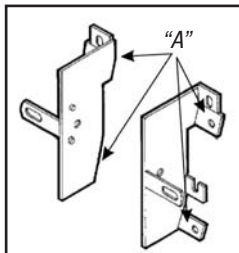

(Figure B)

## Chevrolet Astro/GMC Safari 1996-2005

1. Place the gear selector in its lowest position.
2. Unclip the perimeter of the dash trim bezel. (Figure A)
3. Disconnect the rear A/C control harness and the headlight switch from the back of the dash trim bezel and remove the bezel.
4. Using a flat-blade screwdriver, press down on the outside clips of the factory radio and remove.
5. Locate Bracket Set #8. (Figure B)

Continue to kit assembly

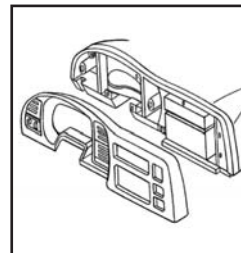

(Figure A)

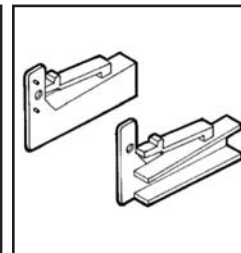

(Figure B)

### Chevrolet Beretta/Corsica 1991-1996

1. Using a panel removal tool, pry outward on the dash trim bezel and remove. (Figure A)
2. Remove (2) screws securing the factory radio and disconnect the wiring.
3. Locate Bracket #7. (Figure B)

*Continue to kit assembly*

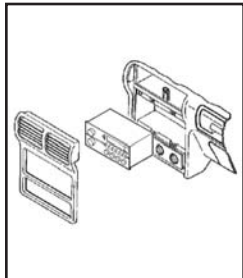

(Figure A)

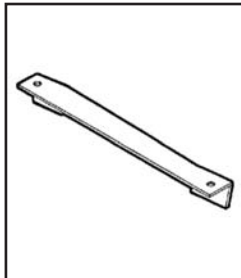

(Figure B)

### Chevrolet Blazer (full size) Suburban/GMC Jimmy (full size) Suburban 1989-1991

1. Remove (2) screws from the radio trim bezel and remove the bezel. (Figure A)
2. Remove (2) screws securing the factory radio and disconnect the wiring.
3. Remove the hardware securing the factory mounting brackets to the factory radio. (Figure B)
4. Remove and retain the brackets.

*Continue to kit assembly*

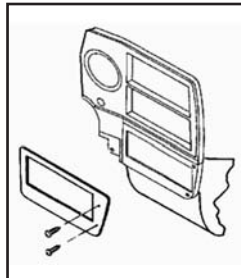

(Figure A)

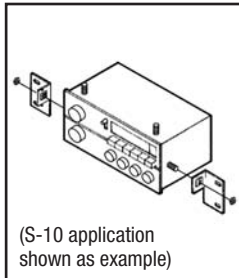

(Figure B)

### Chevrolet 5-10 Blazer/ 5-10 Pickup 1998-2001, GMC 5-15 Jimmy/Sonoma 1998-2001, Isuzu Hombre 1998-2001

1. Remove (2) 9/32" hex-head screws from the knee bolster. (Figure A)
2. Pull down on the bolster and remove 9/32" screws exposed on the base of the dash trim bezel.
3. Remove (1) Phillips screw above the instrument cluster.
4. Unclip the dash trim bezel and remove.
5. Remove (2) 9/32" hex-head screws securing the factory radio and disconnect the wiring.
6. Locate Bracket Set #10. (Figure B)

*Continue to kit assembly*

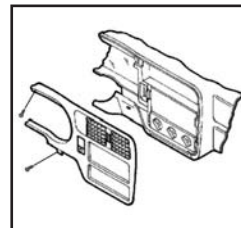

(Figure A)

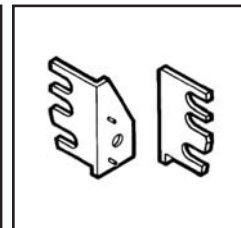

(Figure B)

### Chevrolet Camaro/Pontiac Firebird 1982-1984

1. Remove (4) star-drive screws from the dash trim bezel and remove the bezel. (Figure A)
2. Remove (4) screws securing the factory radio and disconnect the wiring.
3. Cut and remove all mounting tabs on Bracket #2 EXCEPT those tabs with holes "A". (Figure B)

**Note:** Identify mounting tabs by the stamped letter on the back of each tab.

Continue to kit assembly

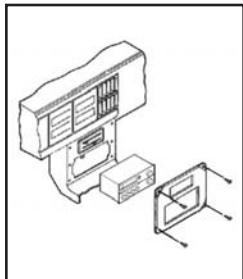

(Figure A)

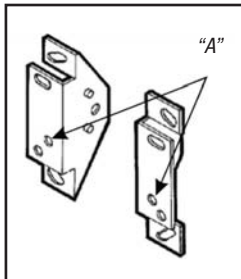

(Figure B)

### Chevrolet Camaro/Pontiac Firebird 1985-1992

1. Remove (4) star-drive screws from the dash trim bezel and remove the bezel. (Figure A)
2. Remove (4) screws securing the factory radio and disconnect the wiring.
3. Cut and remove all mounting tabs on Bracket #2 EXCEPT those tabs with holes "B". (Figure B)

**Note:** Identify mounting tabs by the stamped letter on the back of each tab.

Continue to kit assembly

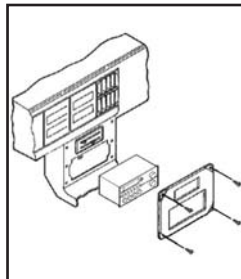

(Figure A)

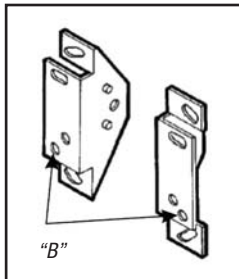

(Figure B)

### Chevrolet Camaro 1997-2002

1. Unclip the radio trim bezel and remove. (Figure A)
2. Remove (2) 7mm hex-head screws securing the factory radio and disconnect the wiring.
3. Locate Bracket Set #10. (Figure B)

**Note:** Identify mounting tabs by the stamped letter on the back of each tab.

Continue to kit assembly

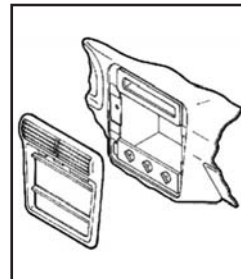

(Figure A)

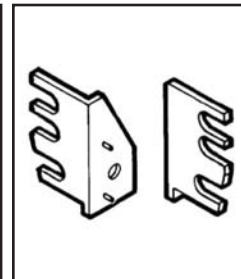

(Figure B)

## Chevrolet Caprice/Impala 1994-1996

1. Remove (5) hex-head screws from the ashtray cavity. (Figure A)
2. Remove (4) hex-head screws from the base of the dash trim bezel. (Figure A)
3. Unsnap the fuse box cover and remove (1) hex-head screw exposed.
4. Remove (2) hex-head screws above the instrument cluster. (Figure A)
5. Place the gear selector in "D1 ". Pull out on the cluster trim and remove.
6. Remove (1) hex-head screw exposed on the left edge of the dash trim bezel.
7. Unclip the dash trim bezel (including the radio trim bezel) and remove.
8. Locate Bracket Set #10. (Figure B)

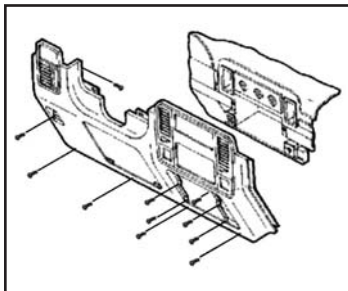

(Figure A)

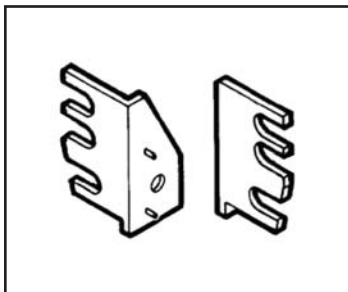

(Figure B)

*Continue to kit assembly*

## Chevrolet Cavalier 1982-1990, Cadillac Cimarron 1982-1988, Pontiac Sunbird with J-2000 panel style factory radio 1982-1988

1. Remove (6) star-drive screws from the dash trim bezel and remove the bezel. (Figure A)
2. Remove (2) screws from the factory radio and disconnect the wiring.
3. Cut and remove all mounting tabs on Bracket #4 EXCEPT tabs "A". (Figure B)

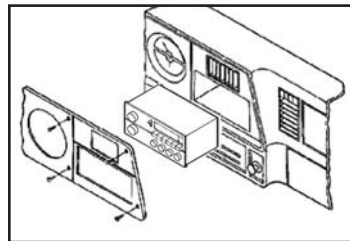

(Figure A)

**Note:** Identify mounting tabs by the stamped letter on the back of each tab.

*Continue to kit assembly*

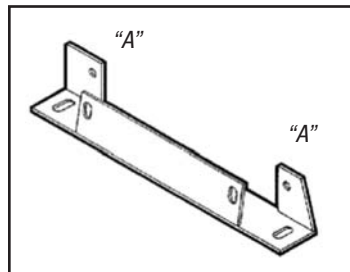

(Figure B)

## Chevrolet Cavalier 1991-1994

1. Using a panel removal tool, carefully pry out on the dash trim bezel and remove. (Figure A)
2. Remove (2) screws securing the factory radio and disconnect the wiring.
3. Cut and remove all mounting tabs on Bracket #3 EXCEPT tabs "B". (Figure B)

**Note:** Identify mounting tabs by the stamped letter on the back of each tab.

Continue to kit assembly

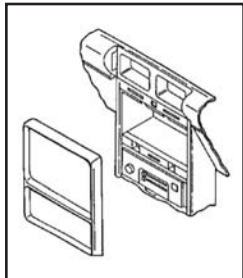

(Figure A)

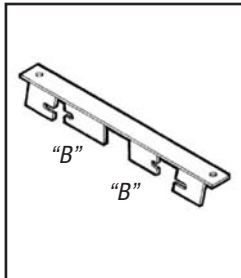

(Figure B)

## Chevrolet Cavalier 1995-1999

1. Open drivers door and remove fuse panel on end of dash then open passenger door and remove panel on end of dash.
2. Remove (1) Phillips screw from each side, now exposed.
3. Remove (3) 7mm hex-head screws from the top of the glove box liner.
4. Remove (2) 7mm hex-head screws from the top-left corner of the glove box cavity.
5. Remove (1) Phillips screw from the defroster duct.
6. Remove the duct work and (1) Phillips screw exposed.
7. Remove the dash pad and (3) Phillips screws exposed at the top of the radio trim bezel. (Figure A)
8. Locate Bracket Set #10. (Figure B)

Continue to kit assembly

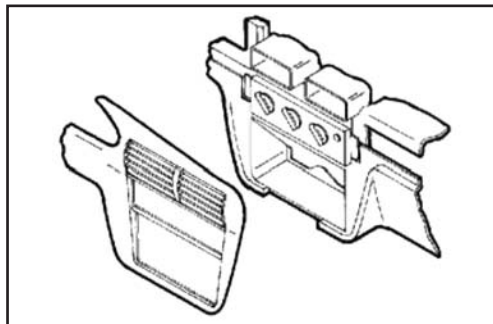

(Figure A)

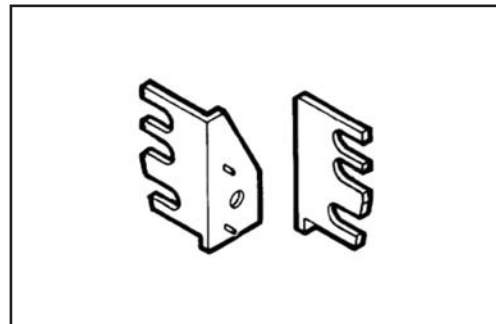

(Figure B)

## Chevrolet Celebrity 1982-1983

1. Remove the plastic plate next to each A/C vent and remove (2) screws exposed. (Figure A)
2. Remove (4) screws surrounding the steering column. (Figure A)
3. Depress the light control knob spring remove the knob and lift the bezel off.
4. Remove the hardware securing the factory mounting brackets to the factory radio. (Figure B)
5. Remove and retain the brackets.

*Continue to kit assembly*

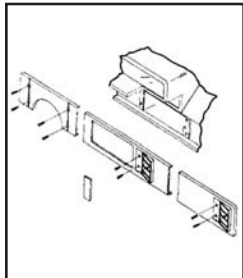

(Figure A)

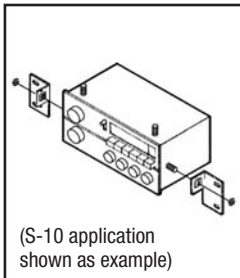

(Figure B)

## Chevrolet Celebrity 1984-1990

1. Remove the glove box compartment by depressing the clip on the bottom of the glove box liner and removing (6) nuts exposed above the opening. (Figure A)
2. Remove (6) Phillips screws below the steering column.
3. Remove the headlight knob by depressing the clip on the back of the knob and removing the nut.
4. Remove the cigarette lighter and disconnect the wiring.
5. Grasp the lighter socket, unscrew the brass nut on the back of the lighter and remove the socket.
6. Remove the dash trim bezel and disconnect the wiring.
7. Remove the hardware securing the factory mounting brackets to the factory radio. (Figure B)
8. Remove and retain the brackets.

*Continue to kit assembly*

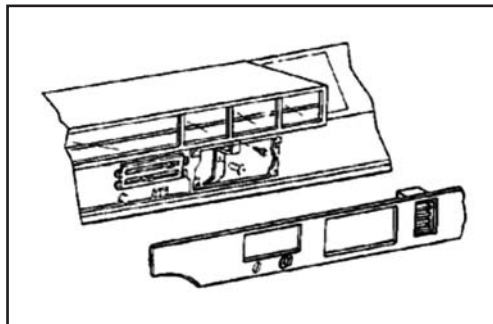

(Figure A)

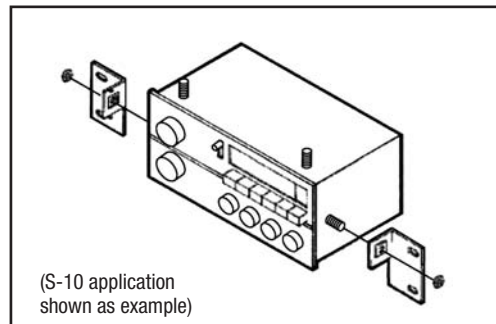

(Figure B)

## Chevrolet Citation II 1985

1. Remove (2) screws from the bottom steering column trim panel and remove. (Figure A)
2. Remove (6) screws from the dash trim bezel, disconnect the wiring and remove. (Figure A)
3. Remove the hardware securing the factory mounting brackets to the factory radio. (Figure B)
4. Remove and retain the brackets.

*Continue to kit assembly*

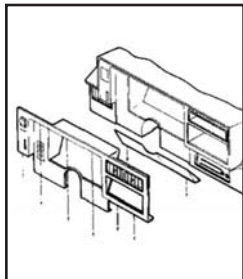

(Figure A)

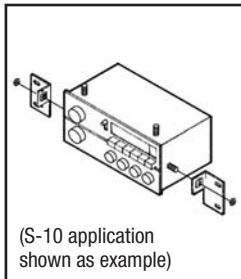

(Figure B)

## Chevrolet Corvette 1984-1989

1. Remove (7) screws from the dash trim bezel. (Figure A)
2. Move the gear shifter to the lowest position.
3. Pull the right edge of the bezel forward, unhook the left side and remove.
4. Remove the hardware securing the factory mounting brackets to the factory radio. (Figure B)
5. Remove and retain the brackets.

*Continue to kit assembly*

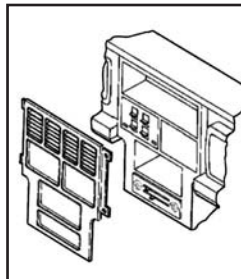

(Figure A)

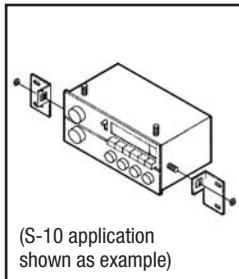

(Figure B)

## Chevrolet Corvette 1997-2004

1. Pry out on the ride control switch and disconnect the wiring.
2. Unsnap the switch trim and remove (2) 10mm hex-head bolts exposed.
3. Open the center console door, remove (4) screws from the inner hinge and remove the door.
4. Open the ashtray and remove (1) screw exposed. Remove the ashtray and (1) screw exposed.
5. Unclip the small grille to the left of the ignition switch and remove (1) screw exposed.
6. Unclip the base of the radio trim bezel and remove. (Figure A)
7. Locate Bracket Set #10. (Figure B)

*Continue to kit assembly*

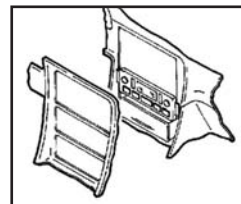

(Figure A)

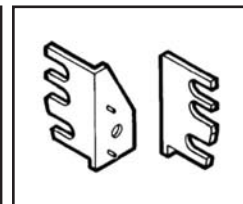

(Figure B)



## Chevrolet El Camino 1986-1987, Monte Carlo 1986-1988

1. Remove (4) screws from the dash trim bezel. (Figure A)
2. Remove the bezel and disconnect the cigarette lighter wiring.
3. Cut and remove all mounting tabs on Bracket #2 EXCEPT tabs "C". (Figure B)

**Note:** Identify mounting tabs by the stamped letter on the back of each tab.

Continue to kit assembly

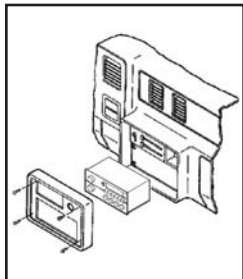

(Figure A)

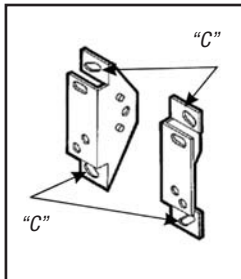

(Figure B)

## Chevrolet Express/GMC Savana 1996-2000

1. Unclip the plastic trim piece located below the steering column.
2. Unclip the dash trim bezel. Pull the bezel over the steering column and disconnect the wiring. (Figure A)
3. Using a flat-blade screwdriver, press down on the outside clips of the factory radio and remove.
4. Locate Bracket Set #8. (Figure B)

Continue to kit assembly

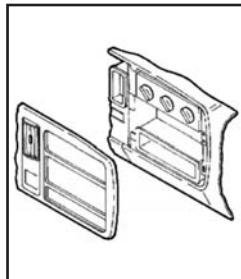

(Figure A)

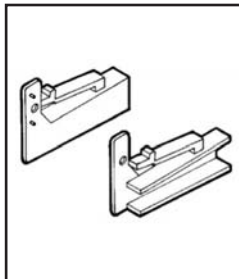

(Figure B)

## Chevrolet Lumina 1990-1994

1. Remove (2) screws from the lower steering column panel.
2. Pull the panel down to access the bottom portion of the radio trim bezel. (Figure A)
3. Pull the top and bottom edges of the bezel. (Figure A)
4. Cut and remove all mounting tabs on Bracket #5 EXCEPT tabs "A". (Figure B)

**Note:** Identify mounting tabs by the stamped letter on the back of each tab.

Continue to kit assembly

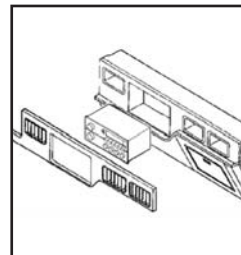

(Figure A)

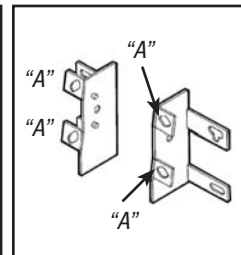

(Figure B)

## Chevrolet Lumina APV/ Oldsmobile Silhouette/ Pontiac TransSport 1990-1995

1. Remove (2) screws securing the lower steering column panel and remove.
2. Remove (2) screws exposed on the left tab of the radio trim bezel. (Figure A)
3. Open the glove box and remove (2) screws exposed on the right tabs of the radio trim bezel.
4. Cut and remove all mounting tabs on Bracket #6 EXCEPT tabs "B". (Figure B)

**Note:** Identify mounting tabs by the stamped letter on the back of each tab.

Continue to kit assembly

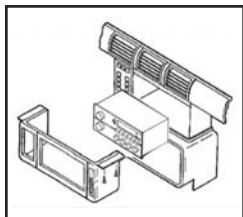

(Figure A)

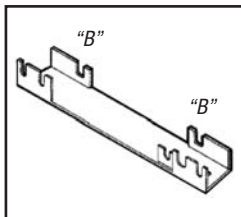

(Figure B)

## Chevrolet Lumina APV/ Oldsmobile Silhouette/Pontiac TransSport 1996

1. Remove (1) Phillips screw from each side of the center console.
2. Open the glove box and remove (2) Phillips screws exposed. (Figure A)
3. Remove (2) 7mm hex-head screws and (1) pop-clip from the lower steering column panel, and (2) Phillips screws exposed near the climate controls.
4. Remove (1) 7mm hex-head screw under the glove box.
5. Pull out on the center console and remove.
6. Cut and remove all mounting tabs on Bracket #6 EXCEPT tabs "B". (Figure B)

**Note:** Identify mounting tabs by the stamped letter on the back of each tab.

Continue to kit assembly

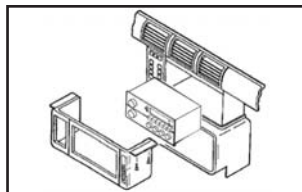

(Figure A)

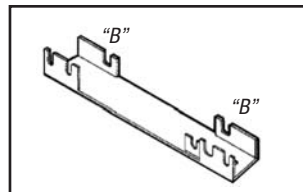

(Figure B)

## Chevrolet Malibu 1997-2000

1. Unclip the radio trim bezel and remove.
2. Remove (2) 9/32" hex-head screws securing the factory radio and disconnect the wiring. (Figure A)
3. Locate Bracket Set #10. (Figure B)

Continue to kit assembly

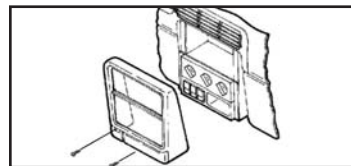

(Figure A)

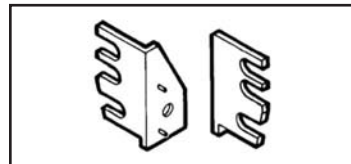

(Figure B)

## Chevrolet Nova 1985-1988

1. Remove the ashtray and (2) screws from the ashtray bracket. (Figure A)
2. Remove (2) screws above the radio opening and remove the radio trim bezel. (Figure A)
3. Cut and remove all mounting tabs on Bracket #1 EXCEPT tabs "B". (Figure B)

**Note:** Identify mounting tabs by the stamped letter on the back of each tab.

Continue to kit assembly

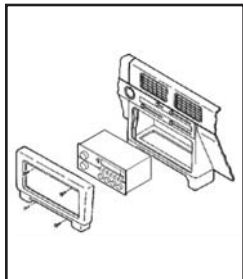

(Figure A)

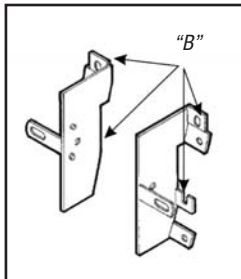

(Figure B)

## Chevrolet 5-10 Pickup/5-10 Blazer 1982-1985 GMC 5-15 Pickup/5-15 Jimmy 1982-1985

1. Remove (4) star-drive screws from the corners of the dash trim bezel. (Figure A)
2. Remove (1) star-drive screw from the lower-right corner of the instrument cluster panel and remove the dash trim bezel.
3. Cut and remove all mounting tabs on Bracket #5 EXCEPT tabs "B". (Figure B)

**Note:** Identify mounting tabs by the stamped letter on the back of each tab.

Continue to kit assembly

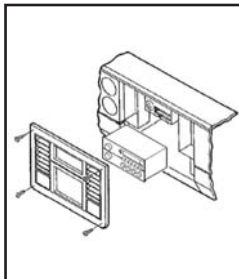

(Figure A)

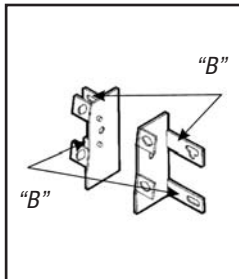

(Figure B)

## Chevrolet 5-10 Pickup 1986-1993/5-10 Blazer 1986-1994, GMC 5-15 Pickup 1986-1990/5-15 Jimmy 1986-1994/Sonoma 1991-1993, Oldsmobile Bravada 1991-1994

1. Remove the ashtray and (1) screw inside the ashtray cavity.
2. Open the glove box and remove (2) screws exposed on the edge of the dash trim bezel. (Figure A)
3. Locate Bracket #(L) S-10 and the right Bracket from Bracket Set #5.
4. Cut and remove all mounting tabs on the right Bracket EXCEPT top tab "B". (Figure B)

**Note:** Identify mounting tabs by the stamped letter on the back of each tab.

Continue to kit assembly

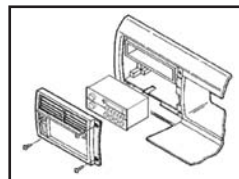

(Figure A)

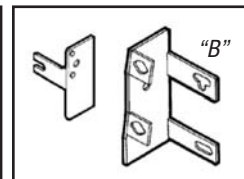

(Figure B)

## Chevrolet Lumina 1995-2001/Monte Carlo 1995-1999

1. Unclip the dash trim bezel and remove (it may be necessary to loosen the knee bolster). (Figure A)
2. Remove (2) 7mm hex-head screws securing the factory radio and disconnect the wiring.
3. Locate Bracket Set #10. (Figure B)  
*Continue to kit assembly*

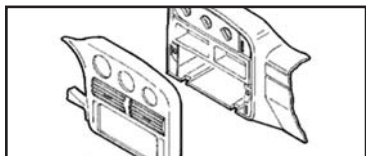

(Figure A)

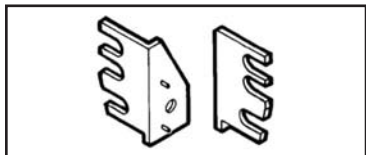

(Figure B)

## Chevrolet/GMC G-Series Van 1988-1996

1. Carefully unsnap the radio trim bezel and remove. (Figure A)
2. Remove (2) screws securing the factory radio and disconnect the wiring.
3. Disconnect the negative battery terminal to prevent an accidental short circuit.
4. Remove the ashtray and (1) Phillips screw exposed in the ashtray cavity.
5. Remove (1) Phillips screw from the cigarette lighter compartment.
6. Remove (2) Phillips screws securing the factory radio and disconnect the wiring.
7. Cut and remove all mounting tabs on Bracket #1 EXCEPT tabs "C". (Figure B)  
**Note:** *Identify mounting tabs by the stamped letter on the back of each tab.*  
*Continue to kit assembly*

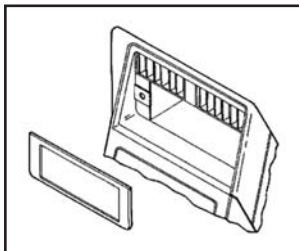

(Figure A)

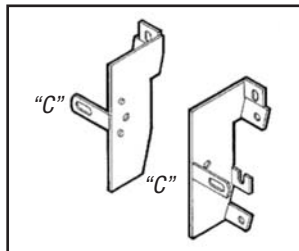

(Figure B)

## Chevrolet Venture/ Oldsmobile Silhouette 1997-1999, Pontiac Montana 1999/Transport 1997-1998

1. Remove the ashtray and (1) Phillips screw exposed in the ashtray cavity.
2. Remove (1) Phillips screw from the cigarette lighter compartment.
3. Remove (2) Phillips screws securing the factory radio and disconnect the wiring.
4. Locate Bracket Set #10. (Figure B)  
*Continue to kit assembly*

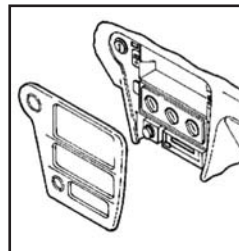

(Figure A)

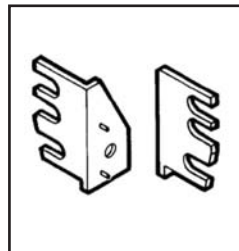

(Figure B)

## Oldsmobile Ninety-Eight 1984-1990/Delta 88 1986-1988

1. Place the gear shifter in low and remove the rubber trim boot from the steering column.
2. Remove (2) Phillips screws from the radio trim bezel.
3. Unhook the ashtray/light wiring terminal and remove the trim bezel. (Figure A)
4. Remove the hardware securing the factory mounting brackets to the factory radio. (Figure B)
5. Remove and retain the brackets.

*Continue to kit assembly*

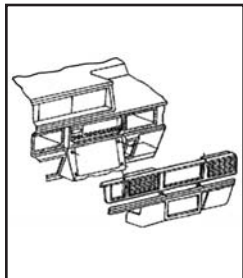

(Figure A)

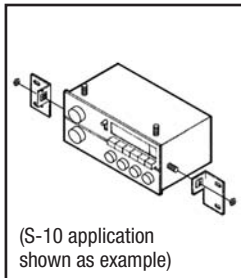

(Figure B)

## Oldsmobile Achieva 1992-1995

1. Remove (4) screws from the top edge of the dash trim bezel. (Figure A)
2. Remove (2) screws from the bottom edge of the bezel. (Figure A)
3. Unsnap the A/C ducts, disconnect the light switch and remove the bezel.
4. Remove the hardware securing the factory mounting brackets to the factory radio. (Figure B)
5. Remove and retain the brackets.

*Continue to kit assembly*

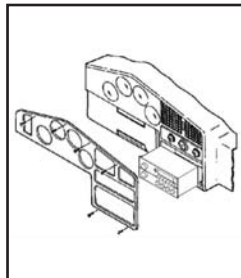

(Figure A)

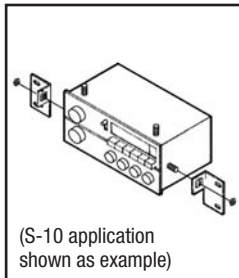

(Figure B)

## Oldsmobile Cutlass Calais 1984-1991

1. Remove the console/glove box assembly and (3) screws below the box.
2. Lift up the parking brake trim and remove (2) screws from the gear shifter trim. (Figure A)
3. Remove the ashtray from the gear shifter area and (2) 7mm screws exposed.
4. Using a screwdriver, depress the retainer tabs on the dash ashtray, pull the ashtray out and remove (2) 7mm hex-head screws from the ashtray bracket.
5. Remove the hardware securing the factory mounting brackets to the factory radio. (Figure B)
6. Remove and retain the brackets.

*Continue to kit assembly*

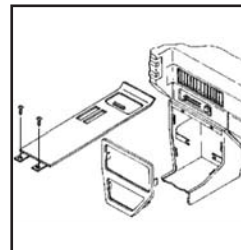

(Figure A)

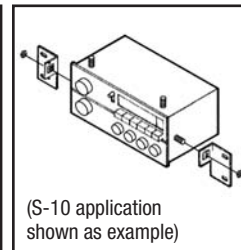

(Figure B)

## Oldsmobile Cutlass Ciera 1982-1996

1. Remove the ashtray and (2) screws from the ashtray location. (Figure A)
2. Remove (1) screw below and (2) screws above the steering column. (Figure A)
3. Pry the A/C vents out and remove the screws exposed in the vent cavities.
4. Remove (6) screws from the edge of the dash trim bezel and remove the bezel. (Figure A)
5. Remove the hardware securing the factory mounting brackets to the factory radio. (Figure B)
6. Remove and retain the brackets.

*Continue to kit assembly*

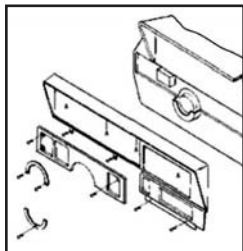

(Figure A)

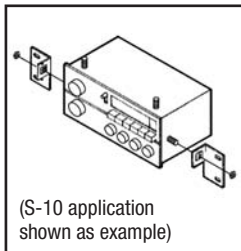

(Figure B)

(S-10 application shown as example)

## Oldsmobile Cutlass Supreme 1984-1988

1. Remove the radio trim bezel, and then disconnect the cigarette lighter connector. (Figure A)
2. Remove the hardware securing the factory mounting brackets to the factory radio. (Figure B)
3. Remove and retain the brackets.

*Continue to kit assembly*

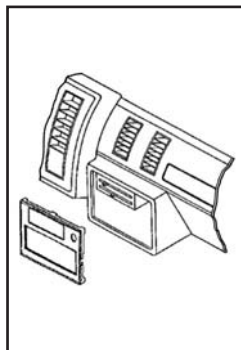

(Figure A)

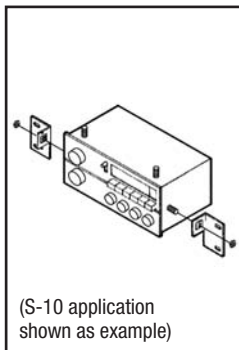

(Figure B)

(S-10 application shown as example)

## Oldsmobile Omega 1983-1984

1. Remove (4) hex-head washer screws from the steering column trim panel, pull down on the rear edge of the panel and remove.
2. Remove (4) Phillips screws from the top edge of the dash trim bezel. (Figure A)
3. Remove (2) hex-head washer screws from the bottom of the dash trim bezel and remove the bezel. (Figure A)
4. Cut and remove all mounting tabs on Bracket #2 EXCEPT tabs "C".

**Note:** Identify mounting tabs by the stamped letter on the back of each tab.

*Continue to kit assembly*

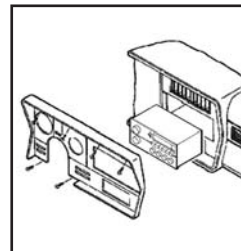

(Figure A)

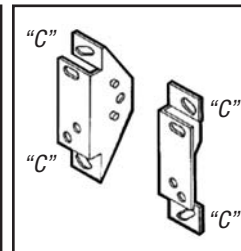

(Figure B)

### Oldsmobile Toronado 1982-1985

1. Depress the clip located behind the headlight knob and remove the knob.
2. Remove (3) screws securing the steering column trim and remove.
3. Remove (4) screws from the bottom edge of the dash trim bezel and remove. (Figure A)
4. Remove the hardware securing the factory mounting brackets to the factory radio. (Figure B)
5. Remove and retain the brackets.

*Continue to kit assembly*

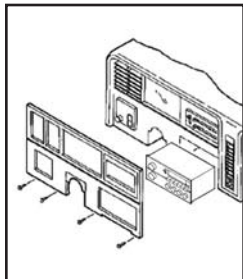

(Figure A)

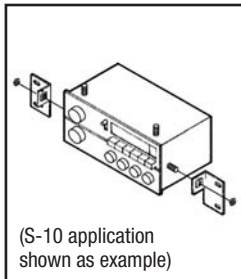

(Figure B)

### Pontiac 6000 1982-1991

1. Open the glove box and remove (1) screw from the side of the radio trim bezel. (Figure A)
2. Gently remove the bezel from the dash and the dummy plate from the bezel.
3. Cut and remove all mounting tabs on Bracket #5 EXCEPT tabs "A". (Figure A)

**Note:** *Identify mounting tabs by the stamped letter on the back of each tab.*

*Continue to kit assembly*

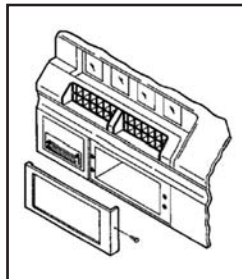

(Figure A)

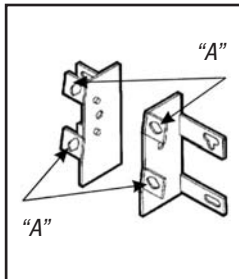

(Figure B)

### Pontiac Bonneville 1987-1993

1. Gently unsnap and remove the dash trim bezel. (Figure A)
2. Remove the screws securing the factory radio and disconnect the wiring.
3. Remove the hardware securing the factory mounting brackets to the factory radio. (Figure B)
4. Remove and retain the brackets.

*Continue to kit assembly*

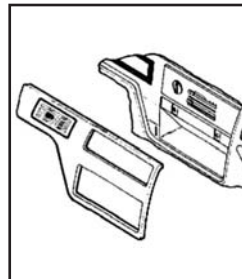

(Figure A)

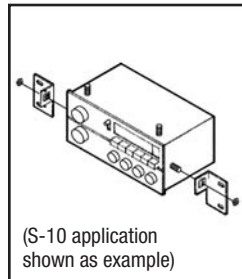

(Figure B)

### **Pontiac Bonneville 1994-1999**

1. Unclip the right side of the dash trim bezel. (Figure A)
2. Unclip the left side of the bezel and remove. (Figure A)
3. Remove (3) 7mm hex-head screws securing the factory radio and disconnect the wiring.
4. Locate Bracket Set #9. (Figure B)

*Continue to kit assembly*

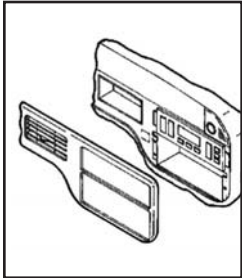

(Figure A)

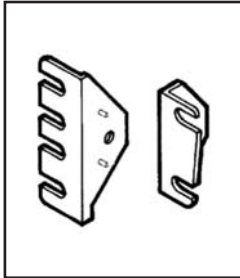

(Figure B)

### **Pontiac Fiero 1984-1988**

1. Remove (4) star-drive screws from the dash trim bezel. (Figure A)
2. Gently pull out on the trim bezel and remove.
3. Remove (4) hex-head screws from the factory radio and disconnect the wiring.
4. Remove the hardware securing the factory mounting brackets to the factory radio. (Figure B)
5. Remove and retain the brackets.

*Continue to kit assembly*

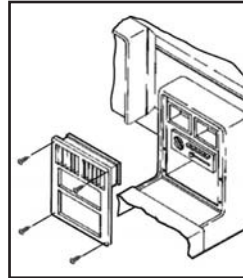

(Figure A)

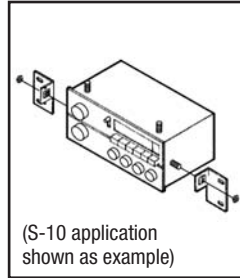

(Figure B)

### **Pontiac Firebird 1993-2002**

1. Unclip the radio trim bezel. (Figure A)
2. Remove (4) 7mm hex-head screws securing the factory radio and disconnect the wiring.
3. Locate Bracket Set #9. (Figure B)

*Continue to kit assembly*

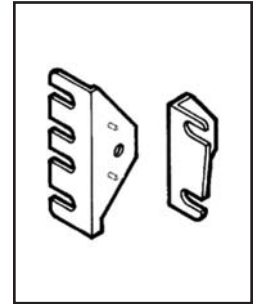

(Figure B)

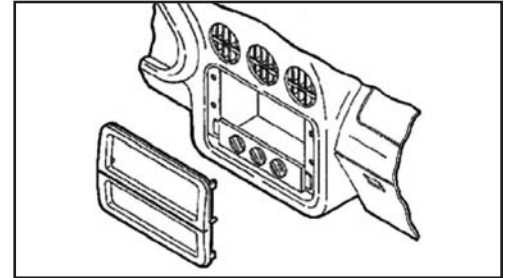

(Figure A)



## Pontiac Grand Am 1985-1991

1. Carefully unsnap the front edge of the gear shifter console panel.
2. Unsnap and remove the dash trim bezel. (Figure A)
3. Remove the hardware securing the factory mounting brackets to the factory radio. (Figure B)
4. Remove and retain the brackets.

*Continue to kit assembly*

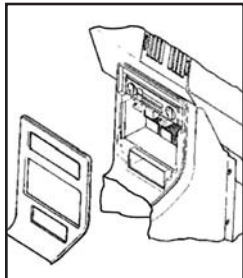

(Figure A)

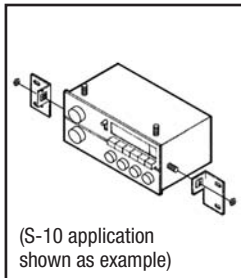

(Figure B)

## Pontiac Grand Am 1992-1995

1. Remove (6) 7mm hex-head screws from the driver's side knee bolster panel and lower the panel.
2. Remove (4) Phillips screws from the glove box/cupholder assembly.
3. Remove (1) 7mm hex-head screw from the left corner of the dash trim bezel. (Figure A)
4. Loosen (2) 10mm nuts from the top of the factory radio, slide the radio out and disconnect the wiring. (Figure A)
5. Remove the hardware securing the factory mounting brackets to the factory radio. (Figure B)
6. Remove and retain the brackets.

*Continue to kit assembly*

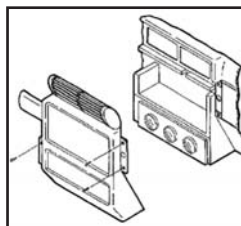

(Figure A)

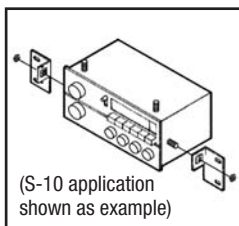

(Figure B)

## Pontiac Grand Am 1996-1998

1. Remove (2) Phillips screws from the pocket.
2. Remove (2) Phillips screws above the instrument cluster. (Figure A)
3. Unclip the dash trim bezel and remove.
4. Remove (3) 7mm hex-head screws securing the factory radio and disconnect the wiring.
5. Locate Bracket Set #9. (Figure B)

*Continue to kit assembly*

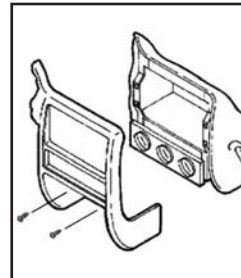

(Figure A)

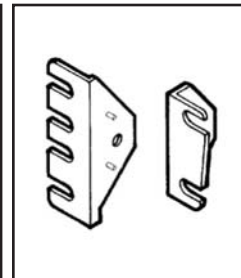

(Figure B)

## Pontiac Grand Am 1999-2000

1. Unclip the radio trim bezel. (Figure A)
2. Remove (3) 9/32" screws securing the factory radio and disconnect the wiring.
3. Locate Bracket Set #9. (Figure B)

*Continue to kit assembly*

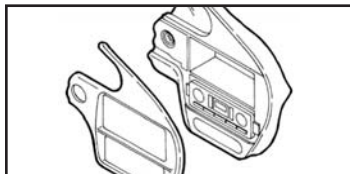

(Figure A)

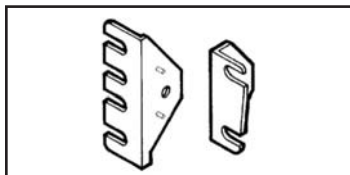

(Figure B)

## Pontiac Grand Prix 1990-1993

1. Remove (1) 9/32" hex-head screw from the computer diagnostic plug and twist to access (1) 9/32" screw on the trim panel.
2. Remove (3) 9/32" screws from the bottom edge of the panel and remove.
3. Open the glove box and remove (4) 9/32" screws from the dash trim bezel. (Figure A)
4. Cut and remove all mounting tabs on Bracket #6 EXCEPT tabs "B". (Figure B)

**Note:** Identify mounting tabs by the stamped letter on the back of each tab.

*Continue to kit assembly*

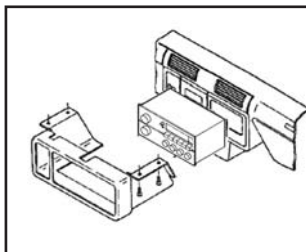

(Figure A)

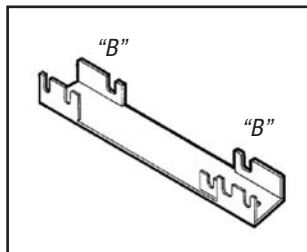

(Figure B)

## Pontiac Grand Prix 1994-1996

1. Using a small set of pliers, grasp the retaining clip on the back of the gear shifter handle and remove the clip.
2. Remove the gear shifter handle. Unclip the center console and remove.
3. Remove (2) 7mm hex-head screws exposed under the climate controls. (Figure A)
4. Unclip the radio trim bezel and remove. (Figure A)
5. Remove (2) 7mm hex-head screws securing the factory radio and disconnect the wiring.
6. Locate Bracket Set #9. (Figure B)

*Continue to kit assembly*

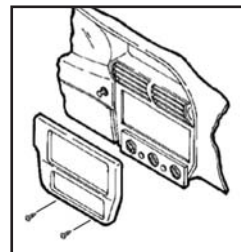

(Figure A)

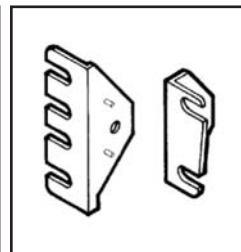

(Figure B)

## Pontiac Grand Prix 1997-2003

1. Unclip the entire dash trim bezel. (Figure A)
2. Remove the screws securing the factory radio and disconnect the wiring.
3. Locate Bracket Set #9. (Figure B)

*Continue to kit assembly*

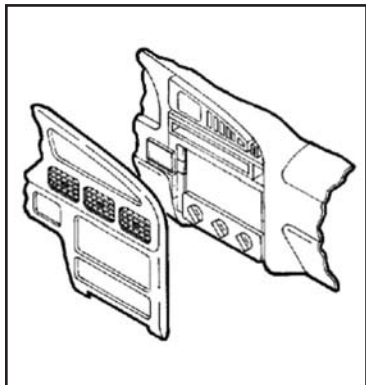

(Figure A)

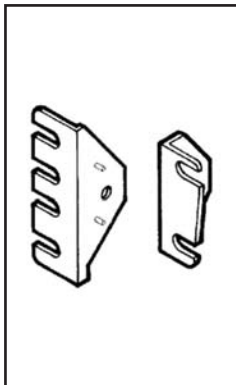

(Figure B)

## Pontiac Grand Prix 1985-1987 Bonneville 1982-1986

1. Remove (3) screws from the top edge of the dash trim bezel.
2. Remove (4) screws from the metal steering column trim and remove the trim.
3. Remove (4) screws exposed at the bottom edge of the dash trim bezel.
4. Remove the cigarette lighter and retainer ring and remove the dash trim bezel. (Figure A)
5. Remove the hardware securing the factory mounting brackets to the factory radio. (Figure B)
6. Remove and retain the brackets. *Continue to kit assembly*

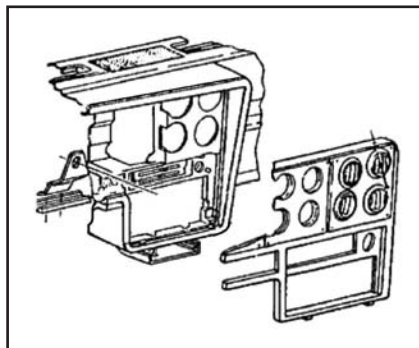

(Figure A)

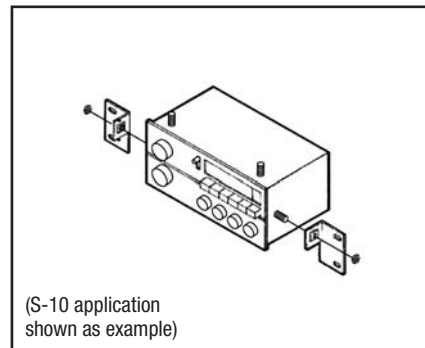

(Figure B)

## Pontiac Sunfire 1995-1999

1. Open the glove box and remove (2) Phillips screws exposed on the right edge of the radio trim bezel. (Figure A)
2. Unclip the bezel and remove.
3. Remove (2) 7mm hex-head screws securing the factory radio and disconnect the wiring.
4. Locate Bracket Set #9. (Figure B)

*Continue to kit assembly*

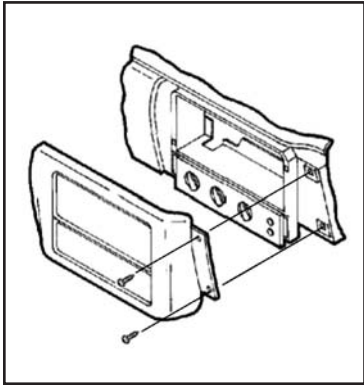

(Figure A)

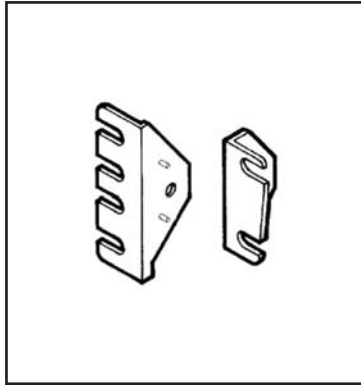

(Figure B)

## Saturn (all models) 1991-1994

1. Gently unclip the dash trim bezel. (Figure A)
2. Remove (2) screws from the factory radio and disconnect the wiring.
3. Cut and remove all mounting tabs on Bracket #6 EXCEPT tabs "A". (Figure B)

**Note:** *Identify mounting tabs by the stamped letter on the back of each tab.*

*Continue to kit assembly*

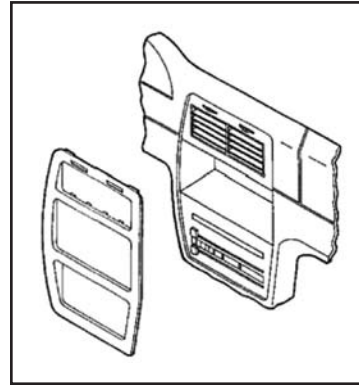

(Figure A)

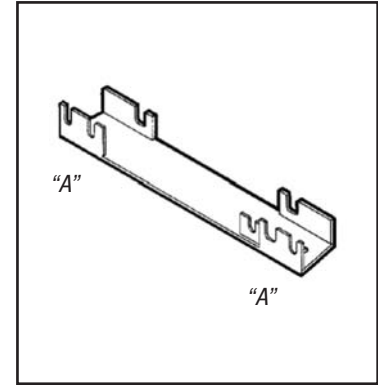

(Figure B)

## DIN radio provision

1. Choose a faceplate (according to the desired installation depth) and snap it onto the front of the radio housing and secure with (4) hex-head screws. (Figure A)
2. Secure mounting brackets to the radio housing with the supplied carriage bolts and nuts. (Figure A)
3. Then snap the rear support tray onto the back of the radio housing. (Figure A)
4. Slide the DIN cage into the kit and secure by bending the metal locking tabs. (Figure B)
5. Locate the factory wiring harness and antenna plug in the dash. Metra recommends using the proper mating adapter from Metra or AXXESS. Reconnect the negative battery terminal and test the radio for proper operation
6. Reassemble dash in reverse order of disassembly using screws previously removed. (Figure B)

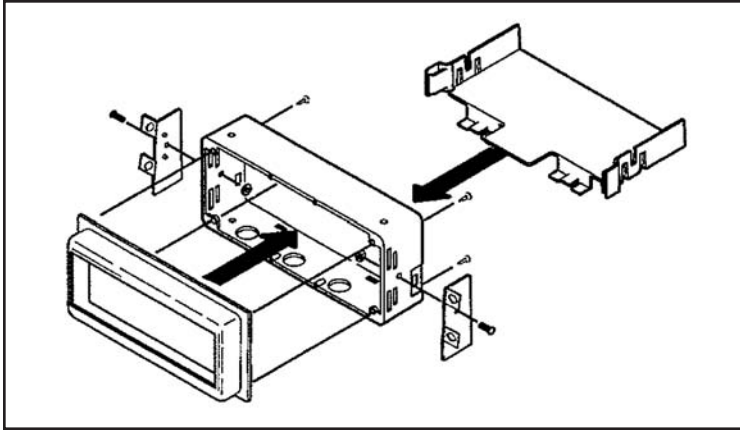

(Figure A)

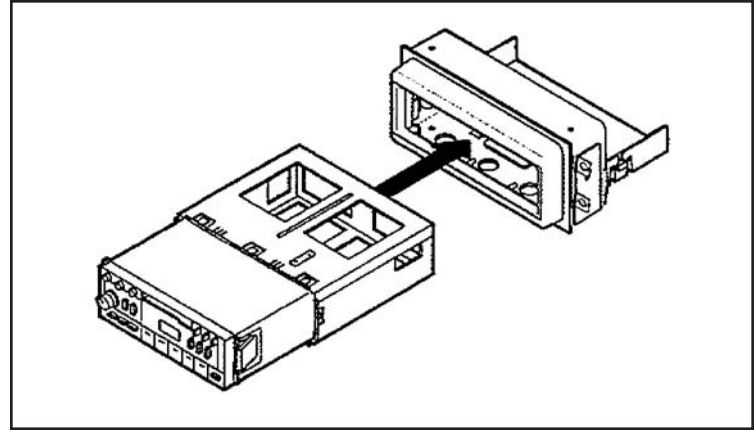

(Figure B)



## Kit Assembly 99-4644

### ISO radio provision

1. Choose a faceplate (according to the desired installation depth) and snap it onto the front of the radio housing and secure with (4) hex-head screws. (Figure A)
2. Snap the ISO trimming into the back of the faceplate. (Figure A)
3. Secure mounting brackets to the radio housing with the supplied carriage bolts and nuts. (Figure A)
4. Then slide the ISO brackets onto the rear support tray and snap the tray onto the back of the radio housing. (Figure A)
4. Slide the radio into the radio opening, aligning the holes in the radio to the holes in the ISO brackets. Then secure the radio to the brackets with the supplied screws. (Figure B)
5. Locate the factory wiring harness and antenna plug in the dash. Metra recommends using the proper mating adapter from Metra or AXCESS. Reconnect the negative battery terminal and test the radio for proper operation.
6. Reassemble dash in reverse order of disassembly using screws previously removed. (Figure B)

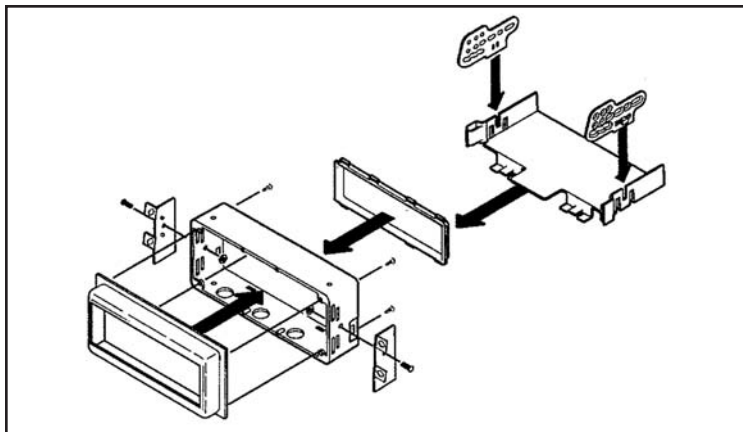

(Figure A)

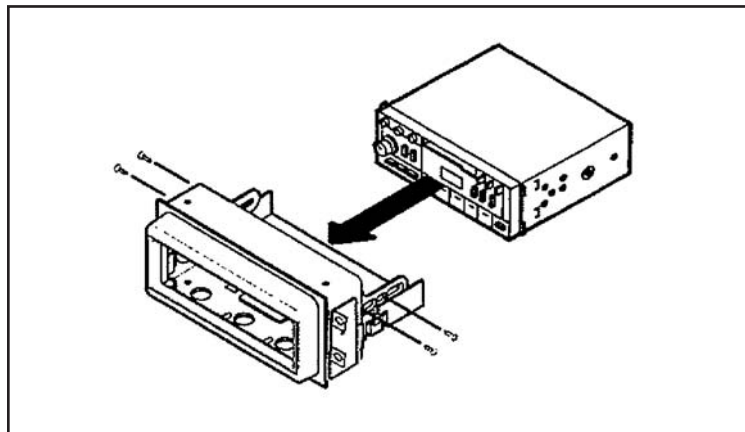

(Figure B)





## INSTALLATION INSTRUCTIONS FOR PART 99-4644



REV. 10/14/2014 INST99-4644



### KNOWLEDGE IS POWER

Enhance your installation and fabrication skills by enrolling in the most recognized and respected mobile electronics school in our industry. Log onto [www.installerinstitute.com](http://www.installerinstitute.com) or call 800-354-6782 for more information and take steps toward a better tomorrow.



**Metra recommends MECP  
certified technicians**