



WHAT'S IN THE BOX

- Saddle Tramp DSP
- BC-9715 Harness
- Instruction Sheet

IMPORTANT: The Saddle Tramp DSP is not a re-flash tool. Please see information on Page 4, regarding usage of the product.

Harley-Davidson Street Glide, Electra Glide, Ultra, and Limited Models 2014-UP Road Glide 2015-UP

Visit metraonline.com to view the available installation parts and Motorcycle accessories.

KIT FEATURES

- Saddle Tramp DSP with radio reflash capabilities
- Reprograms the OE radio to a flat frequency response curve
- All programming is done using the **AXXESS DSP XL** app on Android devices ONLY
- BC-9715 pre-wired harness included for ease of installation
- 15-band graphic EQ, or 5 band parametric EQ per channel
- Up to 6 channels of programmable output
- Fully adjustable crossover

IMPORTANT: For the best performance, and to ensure you're able to use all the features of your Saddle Tramp DSP powered by Axxess technology, we recommend downloading the free Axxess updating software for Windows operating systems at the URL link below:

axsessinterfaces.com/resources/updater-software

TABLE OF CONTENTS

Fairing Disassembly	
Harley Davidson Street Glide, Electra Glide, Ultra, and Limited Model 2014-UP.....	2
Harley Davidson Road Glide 2015-UP	3
Equipment Installation	
Reflashing the OE Radio	4-5
BC-DSPL-HD2 Interface Assembly.....	6
BC-9715 Harness Installation.....	6-9
Mobile App Setup	10-17
Specifications	18
Troubleshooting	19

TOOLS REQUIRED

- Panel removal tool • Phillips screwdriver
- Allen wrenches (FLT Models)
- Torx screwdrivers (FLH and FLT Models)

ATTENTION: With the key out of the ignition, disconnect the negative battery terminal before installing this product. Ensure that all installation connections are secure before cycling the ignition to test this product.

NOTE: Refer also to the instructions included with the aftermarket radio.

FAIRING DISASSEMBLY

Harley Davidson Street Glide, Electra Glide, Ultra, and Limited models 2014-UP

1. Remove (4) T-27 Torx screws from the inner fairing. (Figure A)
2. With a firm grip on the windshield, remove (3) T-27 Torx screws. Remove the windshield, the outer fairing will also be loosened. (Figure B)
3. Remove the outer fairing, unplugging the headlight. (Figure C)
4. Remove (2) T-27 Torx screws to remove the fairing vent, and then remove the vent. (Figure D)

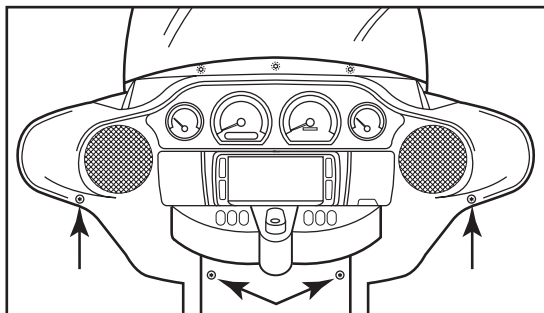

(Figure A)

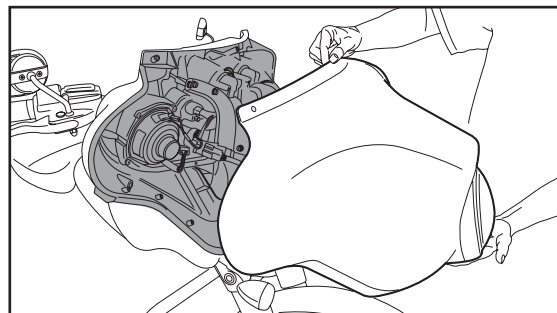

(Figure C)

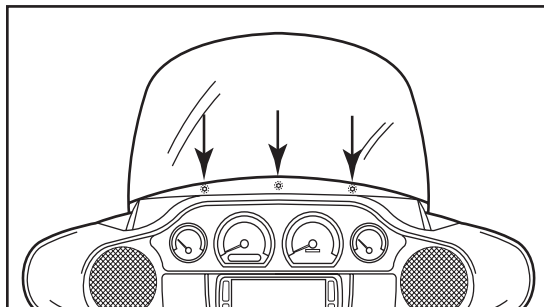

(Figure B)

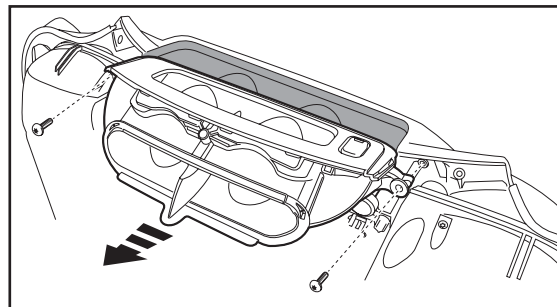

(Figure D)

Continued on next page

FAIRING DISASSEMBLY (CONT)

Harley Davidson Road Glide 2015-UP

1. Remove the lower T-27 Torx screws holding the deflector wings, one on either side. (Figure A)
Note: Only the lower (2) need to be removed.
2. Remove (1) 3/16" Allen screw securing each turn signal. (Figure B)
3. With a firm grip on the windshield, remove (4) Phillips screws and set the windshield aside. (Figure C)
4. Remove the top fairing trim clipped to the top of the radio. (Figure D)
5. Unplug the turn signals.

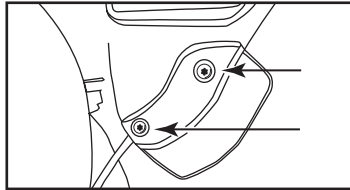

(Figure A)

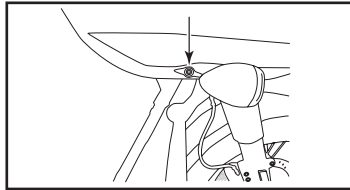

(Figure B)

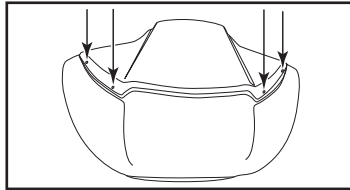

(Figure C)

6. Remove the speaker grills with a panel removal tool and remove (1) Torx screw from each side. (Figure E)
CAUTION: The fairing will be loose at this point. Have a helper hold it to keep from damaging it when removing the screws.
7. Remove the fairing and set aside.
8. Remove (4) 3/16" Allen screws from the sides of the factory radio.
Note: These screws will be reused in the Kit Assembly.
CAUTION: Be sure to hold the radio when removing the last screw so it does not drop.
9. Unplug and remove the radio.
10. Remove (2) Torx screws securing the fairing bracket attached to the radio.
Note: This bracket will be reused in the Kit Assembly. Please note the orientation of the bracket. The curved portion faces the rear of the bike.

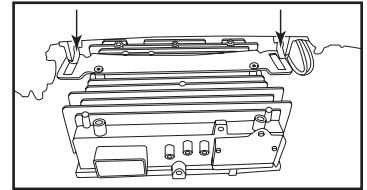

(Figure D)

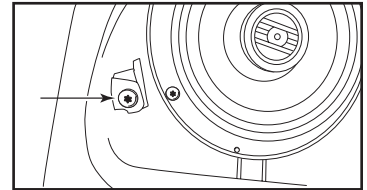

(Figure E)

REFLASHING THE OE RADIO

BC-DSPL-HD2

- Reflashes the OE radio curve to a flat response
- Water Tight Saddle Tramp Case
- 15 Band graphic equalizer or 5 Band parametric EQ per channel
- Pre-wired for quick installation when retaining the OE radio
- BC-9715 harness with pre-wired inputs and outputs
- Independent equalization for all outputs
- Independent crossover for all outputs
- Selectable slope (12, 24, 36, or 48db per octave)
- Signal Delay
- Settings are adjusted using the AXXESS DSP XL app on Android devices ONLY
- Read, write, and store configurations for future recall
- Password protect feature available in the mobile app
- USB Micro-B updatable

Reflashing the OE Radio

Stock non-amplified Harley Davidson's radios use pre-programmed crossover and equalization settings that are locked into the OE radio. These setting can't be adjusted without **reflashing** your OE radio. Within the Vehicle Selection page of the **AX-DSP-XL** app you can **reflash** your OE radio to output a flat frequency response curve.

BC-9715 Harness

- Add an amp harness 2014-up HD with OE radio and fairing
- Provides pre-terminated input and output wires
- RCA output harnesses included
- Pre-wired rear speaker output, used with BC-9720 backbone harness (sold separately)
- Universal for all amps
- Wire covered in protective cloth tape

Product Information: The Saddle Tramp DSP is a device that allows a user to flash the Harley-Davidson® radio to a 4-channel, flat audio output curve; but when the device is connected, it locks itself to the vehicle's identification number (VIN), saving the last known state of the radio into memory. In order to unlock the Saddle Tramp DSP and use it on a different vehicle, or return it, you must remove the flash from the motorcycle, returning the radio back to factory settings. This can only be done 3 times in total. In the event that this product needs to be returned to the manufacturer, it cannot be locked to a motorcycle's VIN.

REFLASHING THE OE RADIO (CONT)

Below are images of the Frequency response curves of a stock Harley Davidson non-amplified radio.

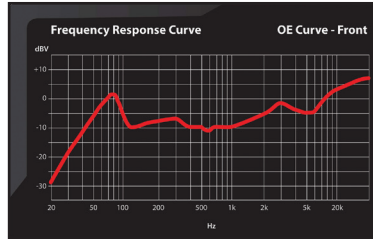
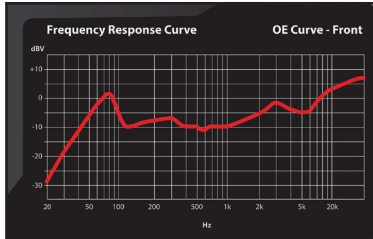

Frequency response curve after the Saddle Tramp DSP **reflashes** the OE radio.

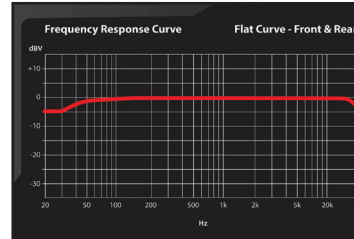

DSP is compatible with these H-D Radios



Works with 4-Button



Works with 11-Button



Works with GTS Touchscreen



BC-DSPL-HD2 INTERFACE ASSEMBLY

Saddle Tramp WR Box Assembly 1

1. Unsnap the **Cap** from the case. Insert the overmolded gaskets from the **BC-9715 harness** into the respective opening in the front of the **Cap**, making sure the grommets are properly seated.
2. Slide the **DSP board** out of the case and plug in the **16 and 20 pin connectors**.
3. Reinsert the **DSP board** into the case and snap the **Cap** into place. The arrows on the **Cap** should be pointed toward the **Saddle Tramp logo** on the case.
4. Find a secure mounting location for the **DSP case**. It is recommended that the cap be installed facing down. The **Zip-tie Mounts** on each side of the case can be used to secure the **DSP** into place.

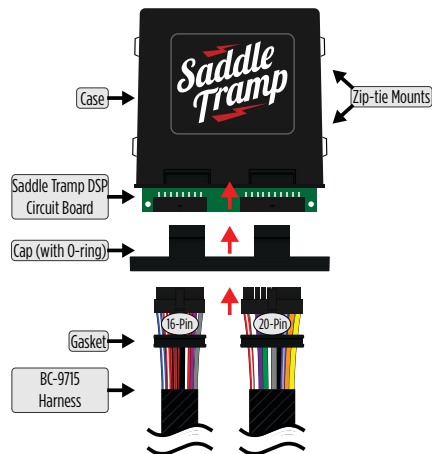

BC-9715 HARNESS

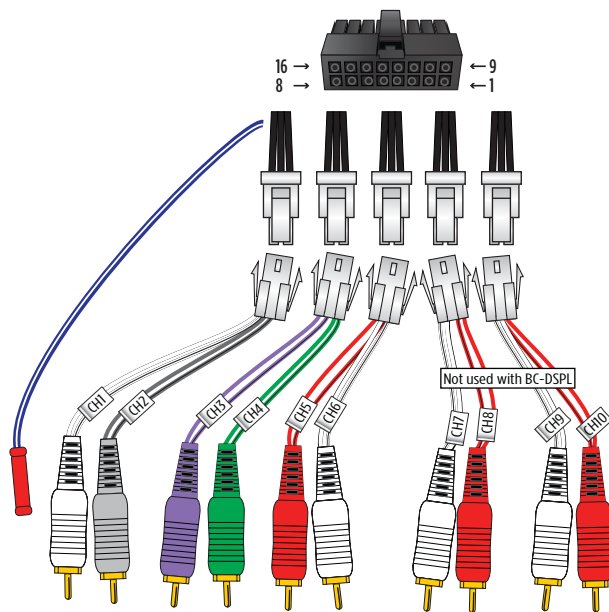

Blue/White - Amp Turn-On

Red/White - Future Use

Channel 6 - User Assignable Output

Sub RCA Jacks - User Assignable Output

Purple RCA Jacks - User Assignable Output

Green RCA Jacks - User Assignable Output

Gray RCA Jacks - User Assignable Output

White RCA Jacks - User Assignable Output

BC-9715 HARNESS INSTALLATION

1. Unplug the OE radio connector and install the **BC-9715 t-harness**.

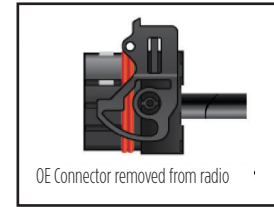
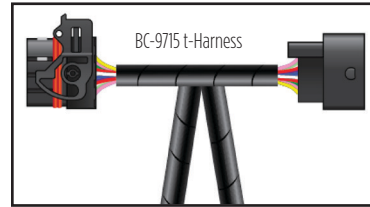
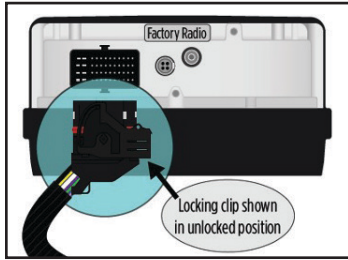

2. The installation of the pre-wired harness is designed to work with multiple styles of aftermarket amplifiers with different types of inputs and outputs. Both **input (white connectors)** and **output (black connectors)** wires on the **BC-9715 harness** use **Molex** terminals that are pre-terminated onto the speaker leads; loose **Molex** connectors are included to allow the user to pin the connectors accordingly.

If the amplifier uses **Molex Micro Fit connectors** for the inputs and outputs, simply match the amplifier's speaker configuration and plug them in using the provided connectors.

If the amp uses **RCA inputs**, pre-terminated **Molex connectors** with **RCAs** already wired are provided. The option to hardwire the speaker inputs and outputs would be the final option.

3. To get battery power and ground wires up the backbone of the motorcycle use **Saddle Tramp's BC-9703 harness**. (Sold separately)

TIP: If you have pinned the Molex Micro fit connector improperly. You will need to use a Pin Extraction tool. (See page 20 for Troubleshooting tips)

BC-9715 HARNESS INSTALLATION

Installation of BC-9715

The diagram shown here provides a visual representation of how the BC-9715 harness should be installed.

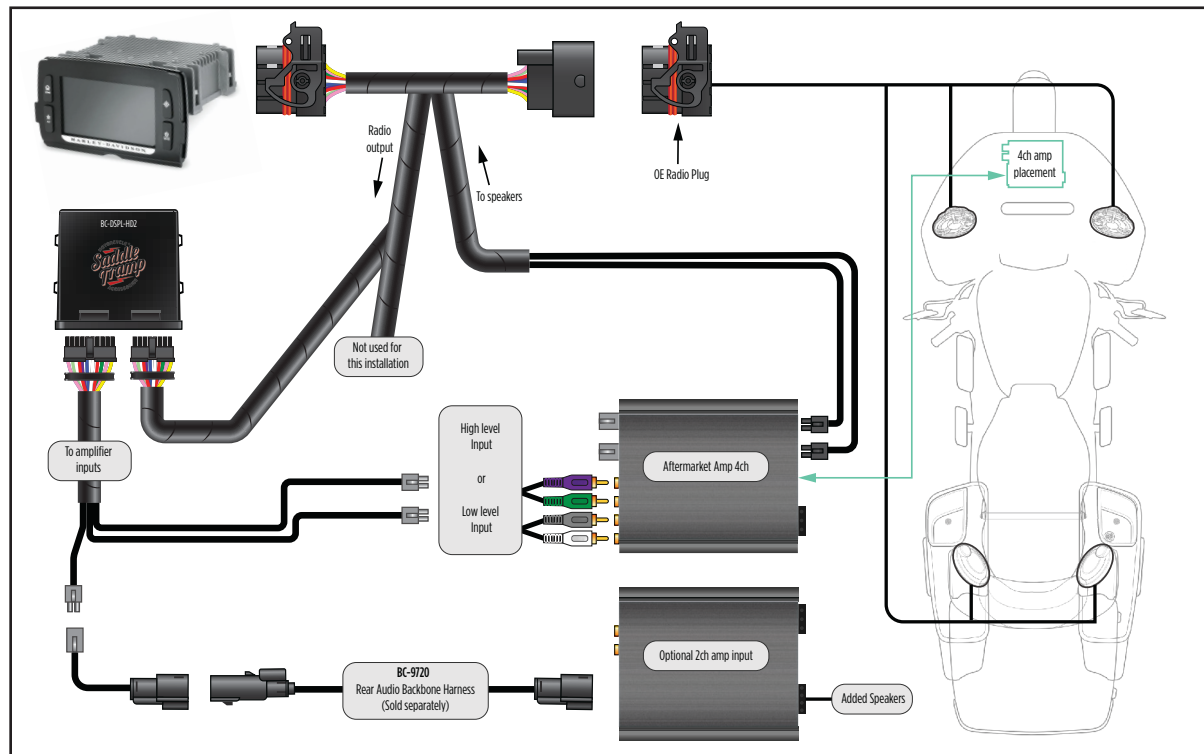

INSTALLATION (CONT'D)

SETUP INSTRUCTIONS

The **Saddle Tramp DSP** uses the **AX-DSP-XL** app, exclusively on Android to program and control the setup of your DSP.



1. Download and install the **AXDSP-XL App** from the **Google Play Store**.
2. Open the app and follow the instructions on the **Bluetooth Connection** tab to pair the mobile device to the **BC-DSPL-HD2**. (Figure A)
3. Scroll to the **Configuration** tab then select the vehicle type. Press the **Lock Down** button to save the configuration. (Figure B)
4. Connect the amp turn-on wire from the **BC-DSPL-HD2 harness**.
5. Click the **Identify** button to confirm that the **BC-DSPL-HD2** is connected properly. If so, a chime will be heard from the front left speaker. Test all functions of the installation for proper operation.

NOTE: We recommend that you update the interface before installation, using the **Axxess updater, Micro-B USB, and a Windows PC**.

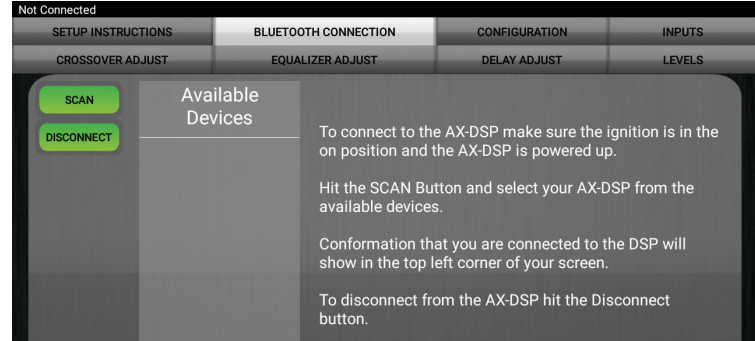

(Figure A)

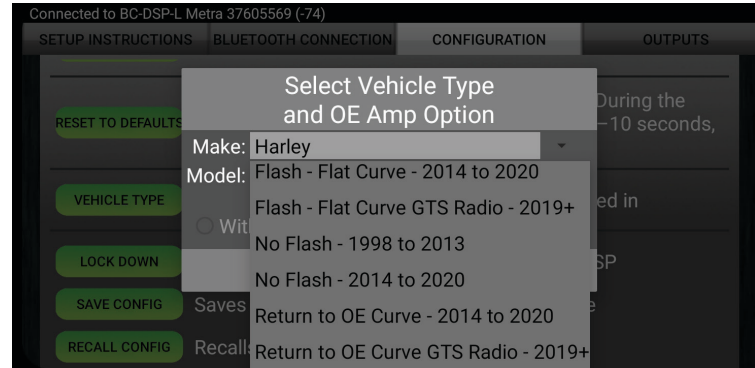

(Figure B)

MOBILE APP

SELECT VEHICLE TYPE

Under the configuration screen is where the user tells the DSP the type of **Harley Davidson** it is connected to. This is also the section that will allow you to **reflash** your radio.

Select Radio type:

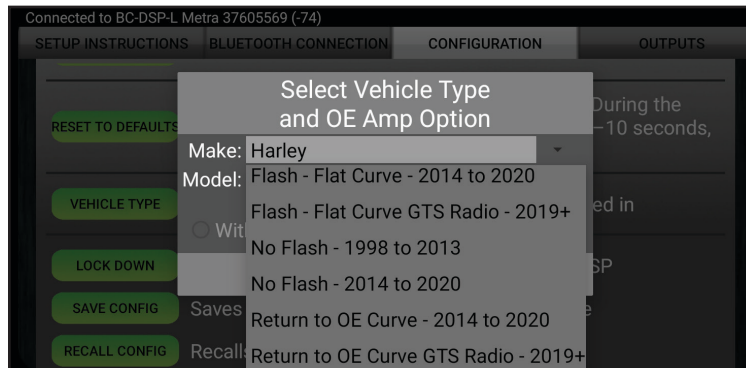

Flash – FLAT CURVE – 2014 TO 2020

Reflash your non-touchscreen factory radio for a flat response.

Flash – Flat Curve GTS Radio – 2019+

Reflash your factory touchscreen radio for a flat response.

No Flash – 1998 to 2013

These radios do not require a Flash.

No Flash – 2014 to 2020

Use if your Harley Davidson had OE amplifier(s)

Return to OE Curve – 2014 to 2020

Flash your non-touchscreen radio back to factory settings.*

Return to OE Curve GTS Radio – 2019+

Flash your non-touchscreen radio back to factory settings.*

**This step is required to use DSP on another motorcycle, or return the device. The Saddle Tramp DSP is a VIN locked device, and not a radio flashing tool.*

MOBILE APP

CONFIGURATION

IDENTIFY: Click this button to confirm that the interface is connected properly. If it is, a chime will be heard from the front left speaker.*

* Only installations where the interface is connected to a front left speaker.

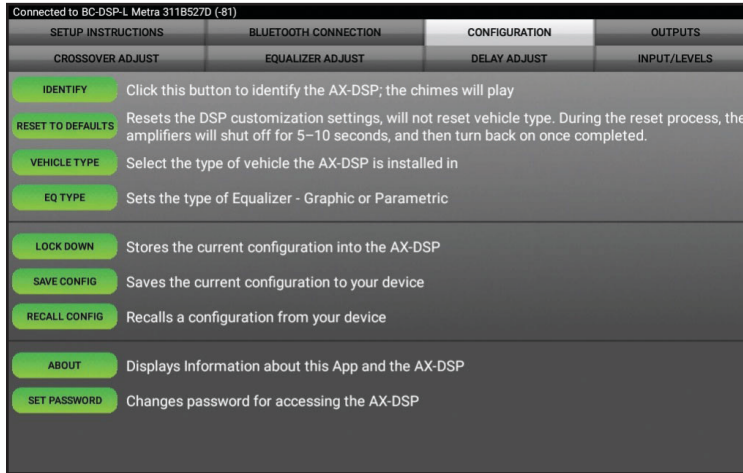

RESET TO DEFAULTS: Resets the interface to factory settings. During the reset process the amplifiers will shut off for 5-10 seconds.

VEHICLE TYPE: Select the vehicle type.

EQUALIZER (EQ) TYPE: User has the option of optimizing the motorcycles sound quality with a Graphic or Parametric equalizer.

LOCK DOWN: Click this button to save the selected settings.

Attention! This button must be selected before closing the app or cycling the key; otherwise, all settings will be lost.

SAVE CONFIGURATION: Saves the current configuration to the mobile device.

RECALL CONFIGURATION: Recalls a configuration from the mobile device.

ABOUT: Displays information about the app, vehicle, interface, and mobile device.

SET PASSWORD: Assign a 4-digit password to lock the interface. If no password is desired, use "0000". This will clear out any currently set password. It is not necessary to lock down the interface when setting a password.

Note: A 4-digit only password must be chosen; otherwise, the interface will show "password not valid for this device".

CROSSOVER ADJUST

Connected to AXDSP-L Metra 38115948 (-79) [WARNING: Settings have changed - Make sure to Lock Down before Exiting App]

SETUP INSTRUCTIONS	BLUETOOTH CONNECTION	CONFIGURATION	OUTPUTS
CROSSOVER ADJUST	EQUALIZER ADJUST	DELAY ADJUST	INPUT/LEVELS

Left Front Lower Freq: 100 Hz

Low Pass 12dB
 Band Pass 24dB
 High Pass 36dB
 48dB

Right Front Lower Freq: 100 Hz

Low Pass 12dB
 Band Pass 24dB
 High Pass 36dB
 48dB

Left Rear Lower Freq: 46 Hz

Low Pass 12dB
 Band Pass 24dB
 High Pass 36dB
 48dB

Right Rear Lower Freq: 100 Hz

Low Pass 12dB
 Band Pass 24dB
 High Pass 36dB
 48dB

Sub Woofer Upper Freq: 100 Hz

Low Pass 12dB
 Band Pass 24dB
 High Pass 36dB
 48dB

If installing a subwoofer, the front and rear outputs will default to a 100Hz high pass filter to keep the low frequency signals out. If a subwoofer is not being installed, change the front and rear crossover points down to 20Hz for a full range signal, or to the lowest frequency the speakers will play down to.

Selecting **High Pass** and **Low Pass** will provide one crossover frequency adjustment. **Band Pass** should only be chosen if installing just front speakers, with one dedicated amp for the woofers/mids, a second dedicated amp for the tweeters, along with a subwoofer.

Select the desired crossover slope, 24db, 36db, or 48 db. Higher is steeper.

MOBILE APP

EQUALIZER ADJUST

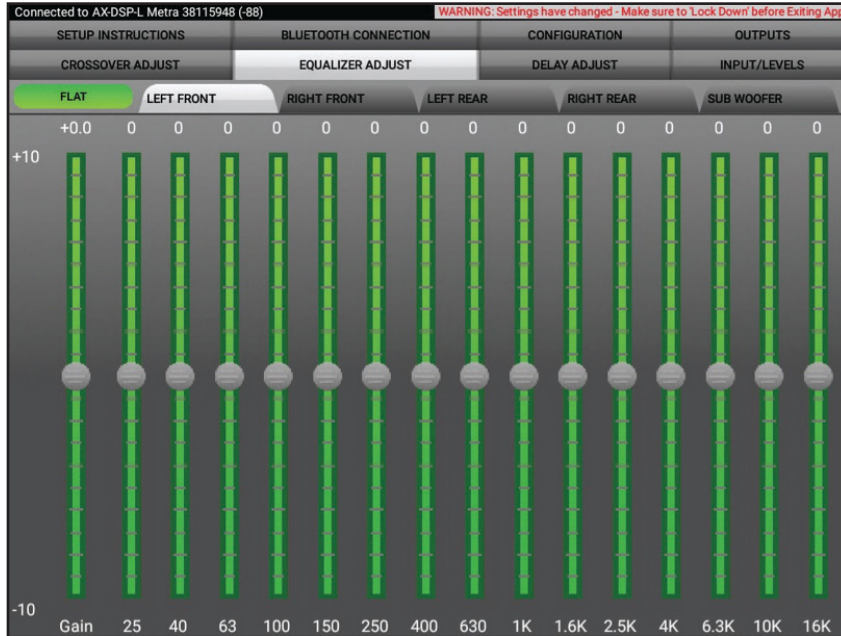

The front, rear, and sub channels can be adjusted independently within this tab with 15 bands of equalization available. It is best to tune this by using an RTA (Real Time Analyzer).

- The **Gain** slider on the far left is for the channel selected.

MOBILE APP

PARAMETRIC EQ



Each output has a **5 Band parametric EQ** per channel. Each band will give the user the ability to adjust:

- Q Factor
- Frequency
- Gain

The **FLAT** button above **Filter #1** will reset all curves back to flat.

MOBILE APP

DELAY ADJUST

Connected to AX-DSPL Metra 38115948 (-84) WARNING: Settings have changed - Make sure to Lock Down! before Exiting App.

SETUP INSTRUCTIONS	BLUETOOTH CONNECTION	CONFIGURATION	OUTPUTS
CROSSOVER ADJUST	EQUALIZER ADJUST	DELAY ADJUST	INPUT/LEVELS

Distance from each speaker to 'Head' position (in inches)

Left Front	0
Right Front	0
Left Rear	0
Right Rear	0
Sub Woofer	0

Measure the distance from each speaker to the desired 'Head' position and enter those values in the corresponding boxes. Maximum distance is 99".

Allows a delay of each channel. If a delay is desired, first measure the distance (in inches) from each speaker to the listening position, then enter those values to the corresponding speaker. Add (in inches) to the desired speaker to delay it.

INPUTS/LEVELS

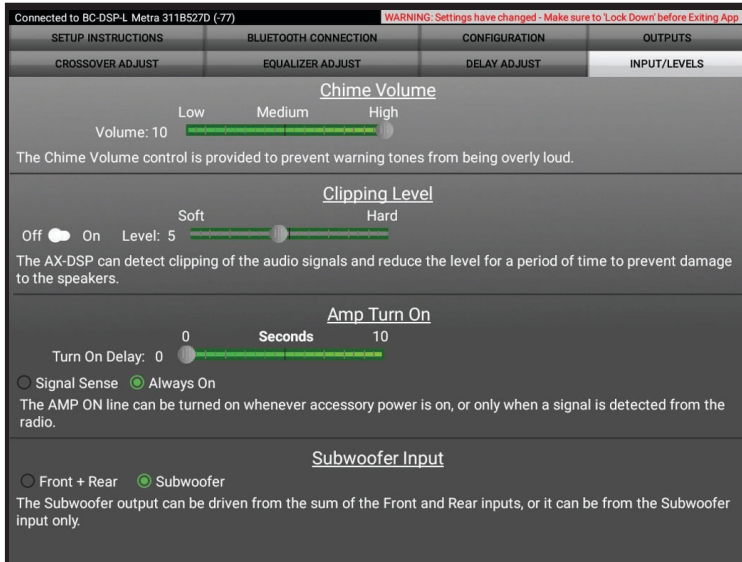

Clipping Level - Use this feature to protect sensitive speakers, like tweeters, from being driven past their capabilities. If the input signal of the DSP clips, the audio will be reduced by 20dB. Turning down the stereo will allow the audio to come back on at a normal level. The sensitivity of this feature can be adjusted to the listening preference of the user.

Chime Volume - Not available in this application.

Amp Turn On

SignalSense - Will turn the amplifier on when an audio signal is detected, and keep on for (10) seconds past the last signal. This ensures the amplifier doesn't shut off between tracks.

Always On - Will keep the amplifiers on as long as the bike is cycled on.

Turn-on Delay - This feature isn't available on 2014-and up Harley Davidson Motorcycles.

Subwoofer Input - For selecting either the sum of the front & rear inputs or the subwoofer LFE input.

LOCKING DOWN DATA

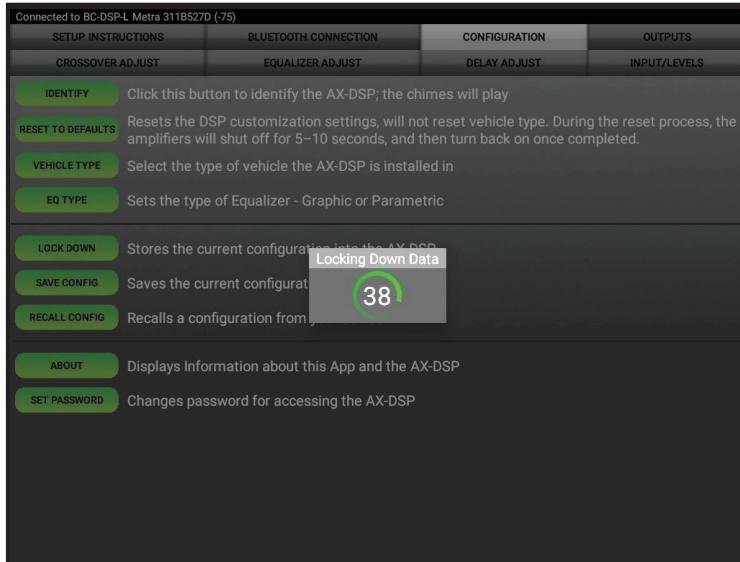

**Last and the most important...
You MUST lock down your configuration!!!**

SPECIFICATIONS

General

- Operating Voltage 10-16-volts
- DC Standby Current Draw 7mA
- Operation Current Draw 150mA
- Adjustments/Controls Application via Bluetooth
- Remote Output 12-volts DC (signal sense or with ignition)

Performance

- Equalizer Type 15 Band Graphic EQ, +/- 10dB
- THD <0.03%
- Frequency Response 20Hz - 20kHz
- Crossover Frequency 3-Way Low pass, Bandpass, High pass
- Crossover Type Linkwitz-Riley
- Crossover Slopes 12, 24, 36, 48
- Sampling 48kHz
- S/N Ratio 105dB @ 5-volts RMS

Inputs

- Input Impedance 1M Ohm
- Input Channels 4
- Input Options High-level or Low-level selectable through Bluetooth app
- Input Type Differential-Balanced
- Input Voltage High Level Range 0 - 28-volts (peak-to-peak)
Low Level Range 0 - 4.9-volts (peak-to-peak)

Outputs

- Output Channels 6
- Output Voltage Up to 5-volts RMS
- Output Impedance 50 Ohms

TROUBLESHOOTING

TIP: If you have pinned the **Molex Micro fit connector** improperly. You will need to use a Pin Extractor tool.

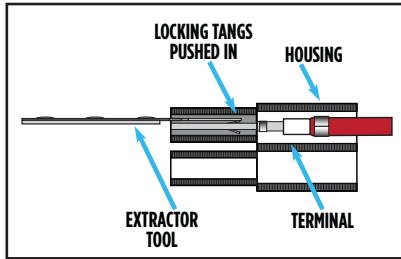
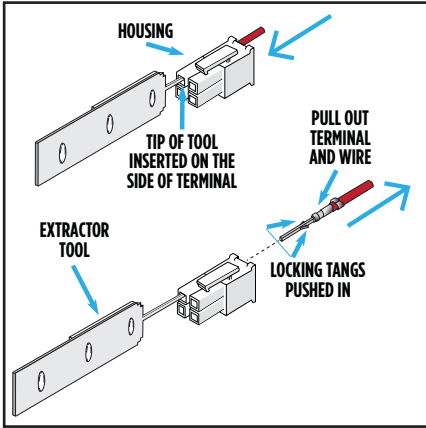

Having difficulties? We're here to help.



Contact our Tech Support line at:

386-257-1187



Or via email at:

techsupport@metra-autosound.com

Tech Support Hours (Eastern Standard Time)

Monday - Friday: 9:00 AM - 7:00 PM

Saturday: 10:00 AM - 7:00 PM

Sunday: 10:00 AM - 4:00 PM



KNOWLEDGE IS POWER

Enhance your installation and fabrication skills by enrolling in the most recognized and respected mobile electronics school in our industry. Log onto www.installerinstitute.edu or call 386-672-5771 for more information and take steps toward a better tomorrow.



**Metra recommends MECP
certified technicians**